

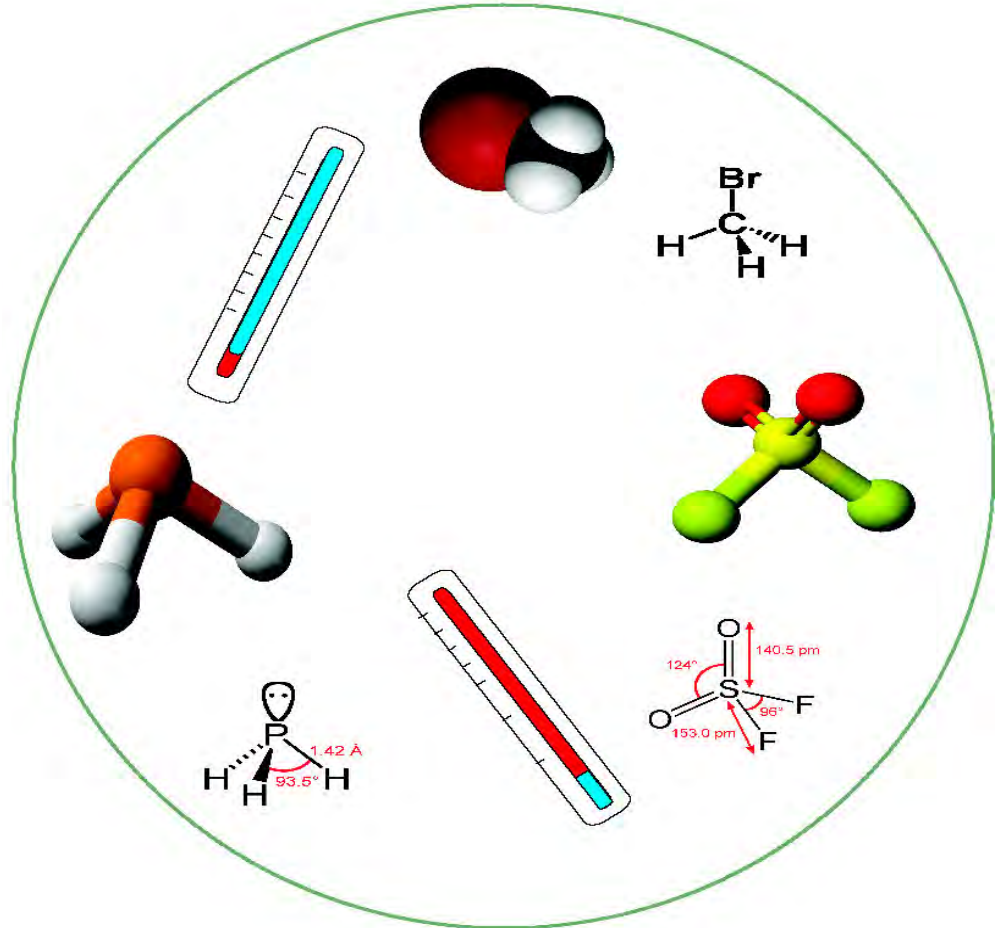

Treatment Manual



Some processes, equipment, and materials described in this manual may be patented. Inclusion in this manual does not constitute permission for use from the patent owner. The use of any patented invention in the performance of the processes described in this manual is solely the responsibility of the user. APHIS does not indemnify the user against liability for patent infringement and will not be liable to the user or to any third party for patent infringement.

The U.S. Department of Agriculture (USDA) prohibits discrimination in all its programs and activities on the basis of race, color, national origin, age, disability, and where applicable, sex, marital status, familial status, parental status, religion, sexual orientation, genetic information, political beliefs, reprisal, or because all or part of any individual's income is derived from any public assistance program. (Not all prohibited bases apply to all programs). Persons with disabilities who require alternative means for communication of program information (Braille, large print, audiotape, etc.) should contact USDA's TARGET Center at (202) 720-2600 (voice and TDD). To file a complaint of discrimination, write to USDA, Director, Office of Civil Rights, 1400 Independence Avenue, SW., Washington, DC 20250-9410, or call (800) 795-3272 (voice) or (202) 720-6382 (TDD). USDA is an equal opportunity provider and employer.

When using pesticides, read and follow all label instructions.

Contents

	<i>TOC-1-1</i>
Figures	<i>LOF-1-1</i>
	<i>LOF-1-1</i>
Tables	<i>LOT-1-1</i>
	<i>LOT-1-1</i>
Introduction	<i>1-1-1</i>
	<i>1-1-1</i>
Chemical Treatments	<i>2-1-1</i>
	<i>Fumigants 2-2-1</i>
	<i>Fumigants—Methyl Bromide 2-3-1</i>
	<i>Fumigants—Methyl Bromide—Tarpaulin Fumigation 2-4-1</i>
	<i>Fumigants—Methyl Bromide—Chamber Fumigation 2-5-1</i>
	<i>Fumigants—Methyl Bromide—Ship Fumigation for Emergency Situations 2-6-1</i>
	<i>Fumigants—Methyl Bromide—Structure Fumigation 2-7-1</i>
	<i>Fumigants—Methyl Bromide—Special Procedures for Container Fumigations Without a Tarpaulin 2-8-1</i>
	<i>Fumigants—Methyl Bromide—Closed-door Container Fumigation 2-9-1</i>
	<i>Fumigants—Sulfuryl Fluoride 2-10-1</i>
	<i>Fumigants—Phosphine 2-11-1</i>
	<i>Aerosols 2-12-1</i>
	<i>Dips 2-13-1</i>
	<i>Dusts 2-14-1</i>
	<i>Sprays 2-15-1</i>
Nonchemical Treatments	<i>3-1-1</i>
	<i>Overview 3-1-1</i>
	<i>Heat 3-2-1</i>
	<i>Heat – Hot Water Immersion 3-3-1</i>
	<i>Heat – Steam Treatments 3-4-1</i>
	<i>Heat – Vapor Heat and Forced Hot Air 3-5-1</i>
	<i>Heat – Forced Hot Air – Niger Seed 3-6-1</i>
	<i>Cold Treatment (CT) 3-7-1</i>
	<i>Irradiation 3-8-1</i>
Residue Monitoring	<i>4-1-1</i>
	<i>Collecting, Packaging, and Shipping 4-1-1</i>
Treatment Schedules	<i>5-1-1</i>
	<i>Index 5-1-1</i>

<i>T100 - Schedules for Fruits, Nuts, and Vegetables</i>	5-2-1
<i>T200 - Schedules for Propagative Plant Material</i>	5-3-1
<i>T300 - Schedules for Miscellaneous Plant Products</i>	5-4-1
<i>T400 - Schedules for Miscellaneous Products</i>	5-5-1
<i>T500 - Schedules for Plant Pests or Pathogens</i>	5-6-1
<i>T600 - Controlled Atmosphere Temperature Treatment System</i>	5-7-1
<i>D301 - Schedules for Domestic Movement of Regulated Articles</i>	5-8-1
Certifying Facilities	6-1-1
<i>Overview</i>	6-1-1
<i>Certification of Vacuum Fumigation Chambers</i>	6-2-1
<i>Certifying Normal Atmospheric Fumigation Chambers</i>	6-3-1
<i>Certification of Cold Treatment</i>	6-4-1
<i>Certification of Hot Water Immersion Facilities</i>	6-5-1
<i>Certification of Niger seed Treatment Facilities</i>	6-6-1
<i>Certification of Forced Hot Air and Vapor Heat Treatment Facilities</i>	6-7-1
<i>Certifying Irradiation Treatment Facilities</i>	6-8-1
<i>Certifying Facilities for the Heat Treatment of Firewood</i>	6-9-1
Hazard Communication Standard	7-1-1
<i>Safety Data Sheets</i>	7-1-1
Emergency Aid and Safety	7-2-1
<i>Guidelines for Managing Pesticide Spills</i>	7-2-1
Equipment	8-1-1
<i>8-1-1</i>	
Glossary	Glossary-1-1
<i>Glossary-1-1</i>	
Appendix A	A-1-1
<i>Forms</i>	A-1-1
Appendix B	B-1-1
<i>Coast Guard Regulations</i>	B-1-1
Appendix C	C-1-1
<i>Conversion Tables</i>	C-1-1
Appendix D	D-1-1
<i>APHIS Certified Treatment Facilities and Conveyances</i>	D-1-1
Appendix E	E-1-1
<i>Reference Guide to Commercial Suppliers of Treatment and Related Safety Equipment</i>	E-1-1
Appendix F	F-1-1
<i>EPA Crop Groups</i>	F-1-1
Appendix G	G-1-1
<i>Respirator Protection Information</i>	G-1-1
Index	Index-1-1
<i>Index-1-1</i>	

Figures

- Figure 2-4-1 Container Arrangement in Two Rows with Both Doors Open 2-4-14
- Figure 2-4-2 Container Arrangement in Two Rows With One Door Open 2-4-14
- Figure 2-4-3 Example of the Position of Gas Sampling Tubes (Side View) 2-4-18
- Figure 2-4-4 Typical Break Bulk Arrangement with Fans, Leads, Introduction Line, Padding, and Sand Snakes 2-4-21
- Figure 2-4-5 Formula for Calculating MB Dosage for Tarpaulin Fumigations 2-4-25
- Figure 2-4-6 Formula for Determining the Amount of Gas to Add to Schedules Not Equivalent to T101-a-1 2-4-33
- Figure 2-4-7 Formula for Determining the Amount of Gas to Add to Schedules Equivalent to T101-a-1 2-4-34
- Figure 2-4-8 Formula to Calculate Air Exchange Rate (AER) 2-4-40
- Figure 2-5-1 Formula for Calculating MB Dosage for Chamber Fumigations 2-5-9
- Figure 2-6-1 Formula for Calculating MB Dosage for Vessel Fumigations 2-6-11
- Figure 2-6-2 Formula for Determining the Amount of Gas to Add for Vessel Fumigation 2-6-14
- Figure 2-8-1 Formula for MB Calculating Dosage for Container Fumigations Without a Tarpaulin 2-8-14
- Figure 2-8-2 Formula for Determining the Amount of Gas to Add for Schedules Not T101-a-1 Equivalent and Conducted in a Container Without a Tarpaulin 2-8-21
- Figure 2-8-3 Formula for Determining the Amount of Gas to Add For T101-a-1 Equivalent Schedules for Container Fumigations Without a Tarpaulin 2-8-22
- Figure 2-8-4 Ductwork configuration for aeration of untarped containers: full loads (top) and partial loads (bottom) 2-8-28
- Figure 2-9-1 Diagram of placement of temperature sensors, represented by a star 2-9-8
- Figure 2-9-2 Formula for Calculating MB Dosage for Closed-Door Container Fumigations 2-9-15
- Figure 2-9-3 Formula for Determining the Amount of Gas to Add to Closed-Door Containerized Cargo 2-9-20
- Figure 2-9-4 Duct work configuration for aeration of closed-door containers: full loads (top) and partial loads (bottom) 2-9-24
- Figure 2-11-1 Diagram of ECO₂FUME® Gas Cylinder 2-11-9

- Figure 2-11-2 Diagram of One Type of Dispensing Equipment for ECO2FUME 2-11-11
- Figure 2-11-3 Diagram of One Type of Blending Equipment for VAPORPH3OS 2-11-15
- Figure 2-11-4 Diagram of VAPORPH₃OS® and Forced Air Blending Equipment 2-11-17
- Figure 2-12-1 Formula for Calculating Aerosol Spray Time in Specific Areas of Aircraft 2-12-2
- Figure 2-12-2 Preparing to Dispense a Partial Can of 2% d-phenothrin + 2% permethrin 2-12-7
- Figure 2-12-3 Preparing to Dispense a Full Can of 2% d-phenothrin + 2% permethrin 2-12-7
- Figure 2-13-1 Example of % Concentrate From Puma® Label (EPA #5813-100) 2-13-5
- Figure 2-13-2 Formula to Determine Total Parts of Water to Prepare a Bleach Disinfectant 2-13-5
- Figure 3-7-1 Proper Placement of Pulp Sensor within Larger Fruit 3-7-7
- Figure 3-7-2 Proper Placement of Pulp Sensor within Smaller Fruit 3-7-7
- Figure 3-7-3 Fruit Stack with Middle Row Temperature Probe Placement 3-7-9
- Figure 3-7-4 40-foot Refrigerated Container with 18 Pallets of Fruit (not drawn to scale) 3-7-10
- Figure 3-7-5 Proper Placement of Cardboard Between the Last Pallet Row of Fruit and the Back Doors of the Container 3-7-10
- Figure 5-4-1 Formula for Determining the Amount of Gas to Add 5-4-37
- Figure 5-5-1 Example of Inadequate Spacing Under Bamboo Bundles 5-5-25
- Figure 5-5-2 Example of Inadequate Spacing Under Bamboo Bundles 5-5-26
- Figure 5-5-3 Example of Adequate Space Above Bamboo Bundles 5-5-26
- Figure 5-5-4 Example of International Plant Protection Convention Marking 5-5-28
- Figure 5-8-1 Formula for Calculating Granular Insecticide for Treating Potting Media for IFA 5-8-21
- Figure 6-3-1 Formula to Calculate Air Exchange Rate (AER) 6-3-7
- Figure 6-8-1 Flow Diagram for Plan Approval Application for Irradiation Facilities in Countries Other Than the United States 6-8-3
- Figure 7-2-1 Abbreviated Spill Plan, Personal Reference Card (Wallet-size) 7-2-2
- Figure 7-2-2 Emergency Contacts for Pesticide Spills 7-2-3
- Figure 7-2-3 Poison Control Center 7-2-4
- Figure 7-2-4 Medical Emergency Facility 7-2-4
- Figure 7-2-5 Federal Aviation Administration (FFA) Office 7-2-5
- Figure 7-2-6 Community-Right-To-Know or Emergency Planning Coordinator (Fire Marshall) 7-2-5
- Figure 7-2-7 Fish and Game Department 7-2-6
- Figure 7-2-8 Regional Veterinary Services (VS) Office 7-2-6
- Figure 7-2-9 Regional Safety and Health Coordinator 7-2-6

Figure 7-2-10	Local Police	7-2-7
Figure 7-2-11	Local Hazardous Waste Official	7-2-7
Figure 8-1-1	Fumiscope® Models D, 4.0, and 5.1	8-1-2
Figure 8-1-2	Fumiscope® Model 5.1	8-1-3
Figure 8-1-3	Spectros Methyl Bromide Monitor	8-1-9
Figure 8-1-4	Methyl Bromide Volatilizer Coil	8-1-15
Figure 8-1-5	Tubing Specifications	8-1-16
Figure 8-1-6	Auxiliary Pump	8-1-19
Figure 8-1-7	Example of Pressure Measurement in an Open-arm Manometer	8-1-20
Figure 8-1-8	Example of U Tube Manometer	8-1-22
Figure 8-1-9	Example of a Water Trap	8-1-26
Figure 8-1-10	Example of an Approved Fan	8-1-28
Figure A-1	APHIS Form 205-R, Instructions and Worksheet for Calibrating Portable Temperature Sensors	A-1-3
Figure A-2	APHIS Form 206-R, Test of the Accuracy of the Permanent RTD Sensors Installed in Hot Water Tanks	A-1-4
Figure A-3	APHIS Form 207-R, Sensor Location Diagram Fruit Weights and Pulp Temperatures	A-1-5
Figure A-4	APHIS Form 208, Performance Test for Mango Hot Water Immersion Tank	A-1-6
Figure A-5	Calibration of Temperature Probes (Cold Treatment)	A-1-7
Figure A-6	Location of Temperature Sensors in Containerized Cargo (Cold Treatment)	A-1-8
Figure A-7	Example of PPQ Form 429A, Fumigation Record, With Tarpaulin (front)	A-1-10
Figure A-8	Example of PPQ Form 429A, Fumigation Record, With Tarpaulin (back)	A-1-11
Figure A-9	Example of PPQ Form 429B, Fumigation Record, Without Tarpaulin (front)	A-1-13
Figure A-10	Example of PPQ Form 429B, Fumigation Record, Without Tarpaulin (back)	A-1-14
Figure A-11	Example of PPQ Form 519, Compliance Agreement	A-1-17
Figure A-12	Example of PPQ Form 523, Emergency Action Notification	A-1-20
Figure A-13	Example of PPQ Form 449-R, Temperature Recording Calibration Report	A-1-30
Figure A-14	Example of PPQ Form 203, Foreign Site Certificate of Inspection and/or Treatment	A-1-32
Figure A-15	Example of PPQ Form 556, In Transit Cold Treatment Clearance Report	A-1-35
Figure A-16	Worksite Specific Respiratory Protection Plan—Template (page 1 of 8)	A-1-37
Figure A-17	Worksite Specific Respiratory Protection Plan—Template (page 2 of 8)	A-1-38
Figure A-18	Worksite Specific Respiratory Protection Plan—Template (page 3 of 8)	A-1-39
Figure A-19	Worksite Specific Respiratory Protection Plan—Template (page	

Figures

	4 of 8)	A-1-40	
Figure A-20	Worksite Specific Respiratory Protection Plan—Template (page 5 of 8)	A-1-41	
Figure A-21	Worksite Specific Respiratory Protection Plan—Template (page 6 of 8)	A-1-42	
Figure A-22	Worksite Specific Respiratory Protection Plan—Template (page 7 of 8)	A-1-43	
Figure A-23	Worksite Specific Respiratory Protection Plan—Template (page 8 of 8)	A-1-44	
Figure G-1	Approved Half Face Respirators	G-1-2	
Figure G-2	Approved Full Face Respirators	G-1-3	
Figure G-3	Approved Organic Vapor/Acid Gas/P100 Cartridges	G-1-3	
Figure G-4	Approved SCBA	G-1-3	
Figure G-5	Approved AirHawk Ultra Elite Spectacle Kit-Sidewire	G-1-4	

Tables

Table 1-1-1	How to Use Decision Tables	1-1-6
Table 1-1-2	Example of a FIFRA Section 18 Exemption Treatment Schedule	1-1-9
Table 1-1-3	Reporting Issues with or Suggestions for the <i>Treatment Manual</i>	1-1-9
Table 2-2-1	Properties of Gaseous Phases of Fumigants	2-2-5
Table 2-3-1	List of Commodities Covered by FIFRA Section 18 Exemption	2-3-3
Table 2-4-1	Determine Reporting Requirements	2-4-7
Table 2-4-2	Determine the Number of Temperature Sensors	2-4-9
Table 2-4-3	Determining Number and Placement of Circulation Fans for Tarped Break Bulk Cargo	2-4-16
Table 2-4-4	Determine Whether to Use Commodity or Air Temperature for Determining Dosage Rate for Nonpulpuy Commodities	2-4-22
Table 2-4-5	Determine the Need to Add Gas and Adjust Exposure	2-4-32
Table 2-4-6	Determine the Extended Exposure Period for Non-equivalent Schedules	2-4-33
Table 2-4-7	Determine Gas Concentration Values and Corrections for Fruits and Vegetables at the 30-minute Reading of T101-a-1 or Equivalent Schedules	2-4-36
Table 2-4-8	Determine Gas Concentration Values and Corrections for Fruits and Vegetables at the 2-Hour Reading of T101-a-1 or Equivalent Schedules	2-4-37
Table 2-4-9	Determine Responsibility for Aerating the Commodity	2-4-39
Table 2-4-10	Determine the Aeration Procedure	2-4-39
Table 2-4-11	Determine When to Release the Commodity for Nonsorptive, Containerized Cargo	2-4-41
Table 2-4-12	Determine When to Release the Commodity for Nonsorptive, Noncontainerized Cargo—Outdoors	2-4-42
Table 2-4-13	Determine When to Release the Commodity for Nonsorptive, Noncontainerized Cargo—Indoors	2-4-43
Table 2-4-14	Determine Number of Fans for Aeration of Fresh Fruits, Vegetables, and Cut Flowers	2-4-44
Table 2-4-15	Determine When to Release the Commodity After Aeration of Fresh Fruits, Vegetables, and Cut Flowers—Indoors or Outdoors	2-4-45
Table 2-4-16	Determine when to Release the Commodity for Sorptive, Non-containerized Cargo—Outdoors	2-4-46
Table 2-4-17	Determine When to Release the Commodity for Sorptive, Non-containerized Cargo—Indoors	2-4-46

Table 2-4-18	Determine When to Release the Commodity for Sorptive Commodities in Containers—Indoors	2-4-48
Table 2-4-19	Determine when to Release the Commodity for Sorptive Commodities in Containers—Outdoors	2-4-49
Table 2-5-1	Determine Whether to Use Commodity or Air Temperature for Determining Dosage Rate	2-5-9
Table 2-5-2	Determine the Responsibility for Aerating the Commodity During Chamber Fumigations	2-5-11
Table 2-5-3	Determine the Aeration Procedure for Chamber Fumigations	2-5-11
Table 2-5-4	Determine When to Release the Commodity After NAP Fumigation	2-5-12
Table 2-5-5	Determine When to Release the Commodity After Vacuum Fumigation	2-5-13
Table 2-6-1	Determine Time for Extended Exposure	2-6-15
Table 2-8-1	Responsibilities for Approving Tarpless Container Fumigations	2-8-3
Table 2-8-2	Determine Whether to Use Commodity or Air Temperature for Determining Dosage Rate For Nonpulpy Commodities	2-8-13
Table 2-8-3	Determine the Need to Add Gas and Adjust Exposure	2-8-20
Table 2-8-4	Determine the Extended Exposure Period to Commodities that are Not T101-a-1 Equivalent	2-8-21
Table 2-8-5	Determine Gas Concentration Values and Corrections for Fruits and Vegetables at the 30-Minute Reading	2-8-24
Table 2-8-6	Determine Gas Concentration Values and Corrections for Fruits and Vegetables at the 2-Hour Reading	2-8-25
Table 2-8-7	Determine Responsibility for Aerating the Commodity for Tarpless Container Fumigation	2-8-26
Table 2-9-1	Determine the Extended Exposure Period for Closed-Door Containerized Cargo	2-9-20
Table 2-10-1	Effect of Hose Inside Diameter on Rate of Gas Introduction through a 25-Foot Hose (approximates, depending on cylinder pressure)	2-10-4
Table 2-10-2	Effect of Hose Length on Rate of Gas Introduction Through a 1/8-Inch Inside Diameter Hose	2-10-4
Table 2-11-1	NIOSH Recommended Respiratory Protection When Applying Phosphine	2-11-7
Table 2-11-2	Amount of Phosphine Liberated by Various Products	2-11-8
Table 2-11-3	Phosphine Residue Tolerances	2-11-31
Table 2-13-1	Common Products Dilution Ratio to Add to 1 Part Bleach	2-13-6
Table 3-4-1	Pressure Temperature Relationships	3-4-2
Table 3-5-1	Example of a Treatment Schedule	3-5-4
Table 3-7-1	Number of Sensors in a Warehouse	3-7-17
Table 5-2-1	Hot Water Dip Time Based on Weight of Fruit	5-2-68
Table 5-2-2	Pest-Specific Minimum Absorbed Dose (Gy) For Any Approved Imported Fruits, Vegetables, and Cut Flowers, and Fruits, Vegetables, and Cut Flowers Moved Interstate from Hawaii, Puerto	

	Rico, and the U.S. Virgin Islands	5-2-79	
Table 5-2-3	Origin and Approved Commodity List for 150 Gy		5-2-80
Table 5-2-4	Origin and Approved Commodity List for 400 Gy		5-2-81
Table 5-2-5	Origin and Approved Commodity List for 300 Gy		5-2-83
Table 5-2-6	Origin and Approved Commodity List for 165Gy		5-2-84
Table 5-4-1	Fumigation Treatment Options for Khapra Beetle Infested Material	5-4-25	
Table 5-4-2	Metric Equivalents for T312-a	5-4-35	
Table 5-4-3	Determine Gas Concentration Values and Corrections for Oak Log Fumigations Using Schedule T312-a	5-4-38	
Table 5-4-4	Determine Gas Concentration Values and Corrections for Oak Log Fumigations Using Schedule T312-a-Alternative	5-4-41	
Table 5-4-5	Amount of Phosphine Liberated by Various Products		5-4-48
Table 5-5-1	T402-b-3-1 Chemical Alternatives	5-5-4	
Table 5-5-2	T402-d Chemical Alternatives	5-5-5	
Table 5-5-3	T404-b-5-1 Chemical Alternatives	5-5-18	
Table 5-5-4	Metric Equivalents for T404-b-1-1	5-5-20	
Table 5-5-5	Pest List for T404-b-1-1, T404-b-1-2, and T404-b-4		5-5-21
Table 5-5-6	Metric Equivalents for T404-d	5-5-25	
Table 5-5-7	Partial Site List	5-5-27	
Table 5-5-8	Metric Equivalents for T404-e-1	5-5-29	
Table 5-5-9	Pesticide Treatment for Pinus radiata and Eucalyptus Wood Chips	5-5-30	
Table 5-5-10	T409-a Chemical Alternatives	5-5-40	
Table 5-5-11	Airbus Industries	5-5-43	
Table 5-5-12	Antonov	5-5-43	
Table 5-5-13	ATR	5-5-44	
Table 5-5-14	BAC (British Aircraft Corp.)	5-5-44	
Table 5-5-15	BAC (Aerospatiale)	5-5-44	
Table 5-5-16	Boeing	5-5-45	
Table 5-5-17	Canadair	5-5-46	
Table 5-5-18	Casa	5-5-47	
Table 5-5-19	Cessna	5-5-47	
Table 5-5-20	Convair	5-5-47	
Table 5-5-21	de Havilland	5-5-48	
Table 5-5-22	Dornier	5-5-48	
Table 5-5-23	Embraer	5-5-49	
Table 5-5-24	Fairchild	5-5-49	
Table 5-5-25	Fokker	5-5-49	
Table 5-5-26	Lockheed	5-5-50	
Table 5-5-27	McDonnell Douglas	5-5-50	
Table 5-5-28	SAAB	5-5-53	
Table 5-5-29	Shorts	5-5-53	
Table 5-5-30	Sidely	5-5-53	
Table 5-5-31	Tupolev	5-5-53	
Table 5-5-32	Vickers	5-5-54	
Table 5-5-33	Military Aircraft	5-5-54	
Table 5-5-34	Amount of Phosphine Liberated by Various Products		5-5-63

Table 5-6-1	Citrus Canker Chemical Treatments	5-6-13
Table 5-8-1	Diazinon Dosages for Nursery Stock	5-8-2
Table 5-8-2	Lambda-Cyhalothrin Dosages for Nursery Stock	5-8-3
Table 5-8-3	Pest-Specific Minimum Absorbed Dose (Gy) for Fruit Fly Irradiation	5-8-3
Table 5-8-4	Food Grade Washing Products for Leaf Washing for ACP	5-8-14
Table 5-8-5	APHIS-approved Insecticides for Control of Psyllids on Citrus	5-8-15
Table 5-8-6	Insecticides for Immersion Treatment of Balled or Containerized Plants	5-8-17
Table 5-8-7	Insecticides and Dosages for Drenching Plants in Containers	5-8-18
Table 5-8-8	Bifenthrin Calculations Based on Bulk Density	5-8-19
Table 5-8-9	Certification Period for Plants in Containers	5-8-19
Table 5-8-10	Emulsifiable Chlorpyrifos Dosage for Balled Plants	5-8-20
Table 5-8-11	Potting Media Bulk Density	5-8-20
Table 5-8-12	Application Rates for Incorporation of Granular Insecticides into Potting Media	5-8-21
Table 5-8-13	Pesticide Dosages for Grass Sod	5-8-23
Table 5-8-14	Sweet Orange Scab Approved Fungicides	5-8-30
Table 5-8-15	Citrus Black Spot Approved Fungicides	5-8-31
Table 6-2-1	Vacuum Chamber Classification Table	6-2-4
Table 6-2-2	Chamber Checklist	6-2-6
Table 6-3-1	Chamber Checklist	6-3-13
Table 6-4-1	Number of Temperature Sensors per Compartment	6-4-6
Table 6-4-2	Number of Temperature Sensors in a Warehouse	6-4-11
Table 6-5-1	Hypothetical Certification Results: Treatment Tank with Multiple Set Points	6-5-3
Table A-1	Instructions for Completing PPQ Form 429A and PPQ Form 429B	A-1-15
Table A-2	Instructions for Completing PPQ Form 519, Compliance Agreement	A-1-18
Table A-3	Distribution of PPQ Form 519, Compliance Agreement	A-1-19
Table A-4	Instructions for Initiating an EAN	A-1-22
Table A-5	Instructions for Completing PPQ Form 449-R	A-1-31
Table A-6	Determine Paperwork to Be Presented upon Arrival of a Pre-cleared Commodity	A-1-33
Table A-7	Distribution of PPQ Form 203, Foreign Site Certificate of Inspection and/or Treatment	A-1-34
Table C-1	Conversion Tables	C-1-1
Table D-1	Hyperlinks to Lists of Certified Treatment Facilities, Vessels, and Containers	D-1-1
Table E-1	Cylinder Tare, Net, and Gross Weights	E-1-25
Table E-2	DC Scientific Glass - Approved Thermometers	E-1-45
Table E-3	Fisher Scientific - Approved Thermometers	E-1-46
Table E-4	VWR - Approved Thermometers	E-1-46

Table E-5	Cole-Parmer - Approved Thermometers	E-1-47
Table F-1	Crop Group 1: Root and Tuber	F-1-2
Table F-2	Crop Group 2: Leaves of Root and Tuber Vegetables	F-1-3
Table F-3	Crop Group 3: Bulb Vegetable (Allium spp.)	F-1-4
Table F-4	Crop Group 4: Leafy Vegetables (except Brassica vegetables)	F-1-5
Table F-5	Crop Group 5: Brassica (Cole) Leafy Vegetables	F-1-6
Table F-6	Crop Group 6: Legume Vegetables (succulent or dried)	F-1-7
Table F-7	Crop Group 7: Leaves of Legume Vegetables	F-1-8
Table F-8	Crop Group 8: Fruiting Vegetables	F-1-9
Table F-9	Crop Group 9: Cucurbit Vegetables	F-1-10
Table F-10	Crop Group 10: Citrus Fruit	F-1-11
Table F-11	Crop Group 11: Pome Fruit	F-1-12
Table F-12	Crop Group 12: Stone Fruit	F-1-13
Table F-13	Crop Group 13: Berries and Small Fruit	F-1-14
Table F-14	Crop Group 14: Tree Nuts	F-1-16
Table F-15	Crop Group 15: Cereal Grains	F-1-17
Table F-16	Crop Group 16: Forage, Fodder, and Straw of Cereal Grains	F-1-18
Table F-17	Crop Group 17: Grass, Forage, Fodder, and Hay	F-1-19
Table F-18	Crop Group 18: Nongrass Animal Feeds (Forage, Fodder, Straw, and Hay)	F-1-20
Table F-19	Crop Group 19: Herbs and Spices	F-1-21
Table F-20	Crop Group 20: Oilseed	F-1-23
Table F-21	Crop Group 21: Edible Fungi	F-1-24
Table F-22	Crop Group 22: Stalk, Stem, and Leaf Petiole Vegetables	F-1-25
Table F-23	Crop Group 23: Tropical and Subtropical Fruit, Edible Peels	F-1-26
Table F-24	Crop Group 23: Tropical and Subtropical Fruit, Edible Peels	F-1-27
Table F-25	Crop Group 23: Tropical and Subtropical Fruit, Edible Peels	F-1-28
Table F-26	Crop Group 23: Tropical and Subtropical Fruit, Edible Peels	F-1-29
Table F-27	Crop Group 24: Tropical and Subtropical Fruit, Inedible Peels	F-1-30
Table F-28	Crop Group 24: Tropical and Subtropical Fruit, Inedible Peels	F-1-31
Table F-29	Crop Group 24: Tropical and Subtropical Fruit, Inedible Peels	F-1-32

Introduction

Contents

Purpose	1-1-2
Restrictions	1-1-2
Scope	1-1-2
What the Manual Does Not Cover	1-1-3
Users	1-1-4
Related Documents	1-1-4
Conventions	1-1-4
Advisories	1-1-5
Boldface	1-1-5
Bullets	1-1-5
Change Bar	1-1-6
Chapters	1-1-6
Contents	1-1-6
Control Data	1-1-6
Decision Tables	1-1-6
Examples	1-1-6
Footnotes	1-1-7
Heading Levels	1-1-7
Hypertext Links (Highlighting) to Tables, Figures, and Headings	1-1-7
Indentions	1-1-7
Italics	1-1-7
Numbering Scheme	1-1-8
Transmittal Number	1-1-8
FIFRA Section 18 Treatment Schedules	1-1-9
Using the Manual	1-1-9
Reporting Issues with or Suggestions for the Treatment Manual	1-1-9
Manual Updates	1-1-10
Ordering Additional Manuals and Revisions	1-1-10

Purpose

The procedures and treatment schedules listed in this manual are administratively authorized for use in the U.S. Department of Agriculture, Animal and Plant Health Inspection Service, Plant Protection and Quarantine (USDA-APHIS-PPQ). The treatment of listed commodities prevents the movement of agricultural pests into or within the United States. An officer may determine that other commodities require treatment to prevent similar pest movement.

NOTICE

Do not treat unlisted commodities until consulting and receiving approval from the USDA-APHIS-PPQ Science and Technology, Treatment Mitigation Technology (S&T-TMT) in Miami, Florida.

Approval from S&T-TMT **must** be obtained any time a treatment schedule is used that is **not** an approved schedule from this manual.

Restrictions

Treatment recommendations listed in this manual are based on uses authorized under provisions of the Federal Insecticide, Fungicide, and Rodenticide Act (FIFRA), as amended. Directions appearing on the label, Section 18 Emergency Exemptions, and manual instructions **must** be followed. Nevertheless, some treatments may damage commodities.

PPQ personnel may **not** make any warranty or representations, expressed or implied, concerning the use of these pesticides.

The occasional use of registered trade names in this manual does **not** imply an endorsement of those products or of the manufacturers by the USDA-APHIS.

Scope

This manual covers treatments for quarantine significant plant pests for imported and domestic commodities.

NOTICE

Do not treat unlisted commodities until consulting and receiving approval from USDA-APHIS-PPQ-S&T-TMT.

Obtain approval from S&T-TMT each time a treatment is used that is **not** an approved schedule from this manual.

This manual is broadly divided into ten sections:

- ◆ Chemical Treatments
- ◆ Nonchemical Treatments
- ◆ Residue Monitoring
- ◆ Treatment Schedules
- ◆ Certifying Facilities
- ◆ Emergency Aid and Safety
- ◆ Equipment
- ◆ Glossary
- ◆ Appendixes
- ◆ Index

Each section contains a Table of Contents, an Overview, and where appropriate, a Methods and Procedures section. The Overview is a broad, general description of what is covered in the section. Methods and Procedures cover the “how to” of that particular activity, as well as procedural and reference material for performing tasks associated with each activity. The Appendixes contain information directly associated with treatment activities, but are placed in the back so they do **not** interfere with the flow of procedural instructions.

What the Manual Does Not Cover

This manual does **not** cover treatments conducted in the United States for export to a foreign country. Export treatments are based on the importing countries’ requirements and may be obtained from the [Phytosanitary Export Database \(PExD\)](#) or official communication from the importing country.

With exports, PPQ does **not** have the authority to require more restrictive measures than the importing country requires. When certifying an export treatment has occurred, ensure that the mandatory components of the treatment are met, and all safety guidelines are followed. Importing countries treatment requirements are provided through published regulations, import permits, and other official communication. Maintain quality assurance at the local level to ensure that all treatments are conducted according to the importing country’s requirements.

Mandatory components to consider related to an export treatment:

1. Follow the current pesticide label.
2. Ensure the safety of the employee.
3. Base the treatment on the foreign country’s import requirements.

For more information, contact the PPQ Export Certification Specialist in your state or state of export. You can also visit the [Export Services Program website](#) or email the general [Export Services mailbox](#).

Users

This manual is used primarily by PPQ officers, PPQ headquarters personnel, and State cooperators involved in conducting treatments. The secondary users of this manual are other government agencies, fumigators, pest control operators, foreign governments, and other interested parties.

Related Documents

The following documents are related to this manual:

- ◆ [Agricultural Commodity Import Requirements \(ACIR\)](#) database
 - ◆ [APHIS Safety and Health Manual](#) (internal document only)
 - ◆ Code of Federal Regulations (CFR)
 - ❖ Title 7 (Agriculture)
 - ❖ Title 46 (Shipping) Chapter 1, Part 147—Interim Regulations for Shipboard Fumigation
 - ◆ Federal Insecticide, Fungicide, Rodenticide Act, as amended
 - ◆ Pesticide labels and labeling
 - ◆ Plant Import Manuals
 - ◆ Safety Data Sheets (SDS)
 - ◆ [Occupational Safety and Health Administration \(OSHA\) Technical Manual](#)
-

Application

This manual serves both as a field manual for employees conducting treatments and as a reference for PPQ officers, program managers, and staff officers. Under APHIS policy, only certified pesticide applicators may conduct or monitor treatments. This manual will also serve as a reference for researching the types of treatments available for imports and to answer questions from importers, industry, and foreign countries.

Conventions

Conventions are established by custom and are widely recognized and accepted. Conventions used in this manual are listed below.

Advisories

Advisories are used throughout this manual to bring important information to your attention. Please carefully review each advisory. The definitions have been updated as to coincide with the American National Standards Institute (ANSI) with the goal of making the warnings easy to recognize and understand, thus limiting the human and dollar cost of foreseeable errors and accidents.¹

DANGER

Danger box is used in the event of imminent risk of death or serious injury.

WARNING

Warning box is used in the event of possible risk of serious injury.

CAUTION

Caution box is used for tasks involving minor to moderate risk of injury.

NOTICE

Notice box is used to alert a reader of important information or Agency policy.

SAFETY

Safety box is used for general instructions or reminders related to safety.

Boldface

Boldface type is used to emphasize important words throughout this manual. These words include, but are **not** limited to: **cannot, do not, does not, except, lacks, must, neither, never, nor, not, only, other than.**

Bullets

Bulleted lists indicate that there is **no** order of priority to the information being listed.

¹ TCIF Guideline, *Admonishments (Safety-Related Warning Message)*, TCIF-99-021 Issue 1, p.4.

Change Bar

A black change bar in the left margin is used to indicate a change appearing on a revised page.

Chapters

This manual contains the following chapters: *Introduction, Chemical Treatments, Nonchemical Treatments, Residue Monitoring, Treatment Schedules, Certifying Facilities, Emergency Aid and Safety, Equipment, Glossary, Appendixes, and Index.*

Contents

Every chapter has a table of contents listing **only** the first- and second-level headings within the chapter.

Control Data

Control data is located at the top and bottom of each page to help users keep track of where they are in the manual and be aware of updates to specific chapters, sections, appendixes, etc., in the manual. At the top of the page is the chapter title and first-level heading for that page. At the bottom of the page is the transmittal number (month, year, number), manual title, page number, and unit responsible for content. To track revisions, use the control data.

Decision Tables

Decision tables are used throughout the manual. The first and middle columns in each table represent conditions, and the last column represents the action to be taken after all conditions listed for that row are considered. Begin with the column headings and move left to right, and if the condition **does not** apply, then continue one row at a time until you find the condition that does apply.

Table 1-1-1 How to Use Decision Tables

If you:	And if the condition applies:	Then:
Read this column cell and row first	Continue in this cell	TAKE the action listed in this cell
Find the previous condition did not apply, then read this column cell	Continue in this cell	TAKE the action listed in this cell

Examples

Examples are used to clarify a point by applying it to a real-world situation. Examples always appear in boxes as a means of visually separating them from the other information contained on a page.

EXAMPLE Examples are graphically placed boxes within the text as a means of visually separating information from other information contained on the page. Examples will always appear in a box.

Footnotes

Footnotes comment on or cite a reference to text and are referenced by number. The footnotes used in this manual include general text footnotes, figure footnotes, and table footnotes.

General text footnotes are located at the bottom of the page.

When space allows, figure and table footnotes are located directly below the associated figure or table. However, for multi-page tables or tables that cover the length of a page, footnote numbers and footnote text **cannot** be listed on the same page. If a table or figure continues beyond one page, the associated footnotes will appear on the page following the end of the figure or table.

Heading Levels

Within each chapter and section there are four heading levels. The first-level heading is indicated by a horizontal line across both left and right columns with the heading language across the left and right columns directly underneath. The body text after a first-level heading is located **inside** the margined text area, one line after the heading language. The second- and third-level headings are inside the margined text area with the body text following underneath. The fourth-level heading is inside the margined text area followed by a period and leading into the text.

Hypertext Links (Highlighting) to Tables, Figures, and Headings

Figures, headings, and tables are cross-referenced in the body of the manual and are highlighted in boldface type. These appear in blue hypertext in the online manual.

EXAMPLE Refer to [Reporting Issues with or Suggestions for the Treatment Manual](#) on page 1-1-9 to determine where to report problems with this manual.

Indentions

Entry requirements which are summarized from CFR's, import permits, or policies are indented on the page.

Italics

The following items are italicized throughout the *Treatment Manual*:

- ◆ Cross-references to headings
- ◆ Publication names
- ◆ Scientific names of commodities

Numbering Scheme

A three-level numbering scheme is used in this manual for pages, tables, and figures. The first number represents the section. The second number represents the chapter. The third number represents the page, table, or figure. This numbering scheme allows for easier updating and adding pages without having to reprint an entire chapter. Dashes are used in page numbering to differentiate page numbers from decimal points.

Transmittal Number

The transmittal number contains the month, year, and a consecutively-issued number (beginning with -01 for the first edition and increasing consecutively for each update to the edition). The transmittal number is **only** changed when the specific chapter sections, appendixes, glossary, tables, or index is updated. If no changes are made, then the transmittal number remains unchanged. The transmittal number **only** changes for the entire manual when a new edition is issued or changes are made to the entire manual.

EXAMPLE 12/2018-14 is the transmittal number for this update and is located in the control data on the pages in this chapter

12 is the month the update was issued

2018 is the year the update was issued

14 is the number (the original new edition was 01, plus 13 updates)

FIFRA Section 18 Treatment Schedules

Treatment schedules which are FIFRA Section 18 Exemptions (such as the example below) are followed by a “Notice” box to help you determine the current exemption status.

Table 1-1-2 Example of a FIFRA Section 18 Exemption Treatment Schedule

Temperature (°F)	Dosage Rate (lb/1000 ft ³)	Minimum Concentration Readings (ounces) At:			
		0.5 hrs	2 hrs	3 hrs	3.5 hrs
90 or above	2	26	19	19	—
80-89	2.5	32	24	24	—
70-79	3	38	29	24	—
60-69	3	38	29	—	24

NOTICE

Do not use this treatment schedule if its FIFRA Section 18 Exemption has expired. For the current exemption status, call your local State Plant Health Director (SPHD).

Using the Manual

Review the contents of this manual to get a feel for the scope of material covered. Glance through the section you will be using, and familiarize yourself with the information organization. Use the table of contents to find the information you need. If the table of contents is **not** specific enough, use the index to find the topic and corresponding page number.

Reporting Issues with or Suggestions for the *Treatment Manual*

Use [Table 1-1-3](#) to determine where to report issues with the *Treatment Manual*.

Table 1-1-3 Reporting Issues with or Suggestions for the *Treatment Manual*

If you:	Then:
<ul style="list-style-type: none"> ◆ Are unable to access the online manual ◆ Have a suggestion for improving the format (layout, spelling, etc.) 	CONTACT the PPQ Manuals Unit at 240-529-0350 or email PPQ.IRM.ISMU.Manuals.Feedback@usda.gov
Disagree with policy, procedures, or the admissibility of a commodity	CONTACT PPQ Import Services Customer Support at 301-851-2046 or 1-877-770-5990 with the reason for the disagreement and a recommendation
Have a urgent situation requiring an immediate response	CONTACT a PPQ treatment specialist by e-mail ppq.ops.treatments@usda.gov

Manual Updates

The PPQ Manuals Unit issues and maintains manuals electronically on the Manuals Unit website. The [online manuals](#) contain the most up-to-date information. Immediate update revisions are distributed via the APHIS Stakeholder Registry to anyone who has subscribed to receive *Treatment Manual* updates. To subscribe to the Stakeholder Registry, register at this [website](#).

Ordering Additional Manuals and Revisions

Although using the online manuals is the preferred method, APHIS employees may order hard copies of manuals from the APHIS-MRP Business Services, Acquisition & Asset Management, Printing, Distribution, Mail, Copier Solutions (PDMCS). Visit the [PDMCS website](#) for detailed information and printing costs. The Manuals Unit is **not** responsible for printing costs.

Chemical Treatments

Overview

Contents

Overview	2-1-1
Fumigants	2-2-1
Aerosols	2-12-1
Dips	2-13-1
Dusts	2-14-1
Sprays	2-15-1

Introduction

The Chemical Treatments section of this manual is organized by chemicals as follows:

- ◆ Fumigants
- ◆ Aerosols and Micronized Dust

Use the Contents in this section to quickly find the information you need. If the Contents is **not** specific enough, then turn to the Index to find the topic and its page number.

Chemical Treatments

Fumigants

Contents

Fumigants—Methyl Bromide	2-3-1
Fumigants—Sulfuryl Fluoride	2-10-1
Fumigants—Phosphine	2-11-1

Introduction

Fumigation is the act of releasing and dispersing a toxic chemical so it reaches the target organism in a gaseous state. Chemicals applied as aerosols, smokes, mists, and fogs are suspensions of particulate matter in air and are **not** fumigants.

The ideal fumigant would have the following characteristics:

- ◆ Easily and cheaply generated
- ◆ Easily detected by human senses
- ◆ Easily diffuses and rapidly penetrates commodity
- ◆ Harmless to foods and commodities
- ◆ Highly toxic to the target pest
- ◆ Inexpensive
- ◆ Insoluble in water
- ◆ Nonexplosive
- ◆ Nonflammable
- ◆ Nonpersistent
- ◆ Nontoxic to plants and vertebrates (including humans)
- ◆ Stable in the gaseous state (will **not** condense to a liquid)

Unfortunately, **no** one fumigant has all the above properties, but those used by APHIS and PPQ have many of these characteristics.

The toxicity of a fumigant depends on the respiration rate of the target organism. Generally, the lower the temperature, the lower the respiration rate of the organism which tends to make the pest less susceptible. Fumigation at lower temperatures requires a higher dosage rate for a longer exposure period than fumigation at higher temperatures.

Fumigants vary greatly in their mode of action. Some kill rapidly while others kill slowly. In sublethal dosages, some fumigants may have a paralyzing effect on the pest while others will **not** allow the pest to recover. Some fumigants have **no** effect on commodities, while others are detrimental even at low concentrations. Commodities vary in their sorption of fumigants and in the effort required to aerate the commodities after fumigation.

Due to the reduction in number of labeled fumigants, there is seldom a choice in selecting fumigants. When there is a choice, factors such as the commodity to be treated, pest and stages present, type of structure, and cost should be considered in selecting a fumigant.

The only authorized fumigants are:

- ◆ Methyl bromide (MB)
- ◆ Phosphine (PH) (There are two chemicals used for phosphine: AP–aluminum phosphide; and MP–magnesium phosphide)
- ◆ Sulfuryl fluoride (SF) (Vikane)

Much of the information on fumigants is based on MB, with modifications as needed for the other fumigants.

Monitoring of Quarantine Treatments

Monitoring of program fumigations is performed to ensure that effective fumigant concentration levels are maintained throughout the treatment to prevent the introduction of quarantine pests. Quarantine fumigations employing restricted use pesticides require careful monitoring to assure efficacy and personal safety, to maintain pesticide residues within acceptable limits, and to preserve commodity quality. These requirements are included in the fumigant label, and it is a violation of Federal law to use fumigants and pesticides in a manner inconsistent with their labeling.

Nonperishable Commodities in Commodities Temporary Enclosures

PPQ officers will provide onsite monitoring from introduction of the fumigant through completion of the 2 hour gas concentration readings. Half hour and 2 hour readings are required for these treatments. These readings and general observations permit the officer to determine how a particular treatment is progressing and to make necessary corrections to the enclosure or fumigant concentration level.

Perishable Commodities in Temporary Enclosures

The monitoring officer will remain on the site through the entire fumigation of perishable commodities. Continuous monitoring allows the officer to alert the pest control operator at any time to implement necessary corrective measures. Due to the nature of the commodity and the length of treatment, onsite monitoring of yam and chestnut fumigations may be interrupted after the 2 hour reading when efficacy and safety considerations warrant.

These instructions do **not** prevent the officer from leaving the immediate fumigation site for brief periods when it is necessary and safe to do so. The pest control operator **must** be notified of the PPQ officer's intended absence. These absences would ordinarily be limited to 20 minutes (e.g., restroom breaks or a medical condition) and do **not** constitute a break in service. These practices are in place in many locations and will require only minor modifications in other areas.

Fumigation Guidelines

The following fumigation guidelines are commonly used throughout this manual:

- ◆ Blowers or fans should be operated as follows:
 - ❖ For all bulk material, forced recirculation is required, check for uniform gas distribution by taking gas readings at four or five locations, including at least three from the commodity
 - ❖ For propagative material (T200-series schedules), the entire period of exposure, whether NAP or vacuum
 - ❖ Under tarpaulin (and vacuum fumigation for other than propagative material), fans should operate for 30 minutes after gas introduction or until an APHIS-approved gas detection device indicates uniform gas distribution

NOTICE

Phosphine fumigations **do not** require fans.

- ◆ Dosages are listed by weight in the treatment schedules. If liquid measures are needed, convert from weight to volume using the conversion figures.
- ◆ Dosage rate is based on 1,000 cubic feet of enclosure space, whether chamber, tarpaulin, van, freight car, ship hold, etc. Calculate dosage from the volume of the tarped fumigation enclosure.
- ◆ All chamber fumigations should be conducted in USDA-approved chambers. (Refer to [Certification of Vacuum Fumigation Chambers](#) on page 6-2-1 or [Certifying Normal Atmospheric Fumigation Chambers](#) on page 6-3-1.)

- ◆ Methyl bromide treatment schedules are indicated as “MB.” MB generally refers to any methyl bromide label. Specific MB label restrictions are noted in this manual for the “Q” label. Always check the label of the fumigant to be sure the commodity is listed on the label. Commodities that are **not** listed on the fumigant’s label are **not** authorized for fumigation with the manufacturer’s gas.
- ◆ Ounces per 1,000 cubic feet (oz/1,000 ft³) is equal to milligrams per liter (mg/liter) and is equal to grams per cubic meter (g/m³).
- ◆ Specified vacuum should be held throughout the exposure period
- ◆ Volume of commodity being treated should **not** exceed two-thirds of enclosure volume unless otherwise specified in the treatment schedule

Physical Properties of Fumigants

Table 2-2-1 summarizes the properties of fumigants:

Table 2-2-1 Properties of Gaseous Phases of Fumigants

Properties	Methyl bromide	Phosphine	Sulfuryl fluoride
Chemical Formula	CH ₃ Br	PH ₃	SO ₂ F ₂
Boiling Point	3.6 °C (38.5 °F)	-87.7 °C (-125.9 °F)	-55.2 °C (-67 °F)
Vapor Density ¹	3.3	1.17	3.7
Flammability Limits in Air (v/v%)	10-15 percent by volume	>1.79 percent by volume	Nonflammable
Odor	Odorless	Garlic-like	Odorless
Effects on Metals	Reacts with aluminum, may damage electronic equipment	Copper, brass, gold, and silver severely damaged; electronic equipment damaged, other metals slightly affected in high humidity.	Non-corrosive

1 Vapor density is the weight of gas in air, with '1' as the weight of air.

Chemical Treatments

Fumigants—Methyl Bromide

Contents

Properties and Use	2-3-1
Section 18 Exemption Treatment Schedules	2-3-2
Leak Detection and Gas Analysis	2-3-5
Effects of Temperature and Humidity	2-3-8
Packaging Materials Approved for Fumigation	2-3-8
Sorption	2-3-10
Residual Effect	2-3-11

Properties and Use

Methyl bromide (MB) (CH_3Br) is a colorless, odorless, nonflammable fumigant. MB boils at 38.5 °F and has a very low solubility in water. As a gas, MB is three times heavier than air. As a liquid at 32 °F, 1 pound of MB is equivalent to 262 ml. For ease in transportation and handling, MB is compressed and stored in metal cylinders as a liquid.

MB is an effective fumigant for treating a wide variety of plant pests associated with a wide variety of commodities. MB is the most frequently used fumigant in quarantine fumigations. MB may also be used to devitalize plant material. MB is effective in treating the following pests:

- ◆ Fungi (such as oak wilt fungus)
- ◆ Insects (all life stages)
- ◆ Mites and ticks (all life stages)
- ◆ Nematodes (including cysts)
- ◆ Snails and slugs

MB is effective over a wide range of temperatures (40 °F and above). In general, living plant material tolerates the dosage rate specified, although the degree of tolerance varies with species, variety, stage of growth, and condition of the plant material. MB accelerates the decomposition of plants in poor condition.

Since MB is three times heavier than air, it diffuses outward and downward readily, but requires fans to ensure upward movement and equal gas distribution. Fan circulation also enhances penetration of MB into the commodity. A volatilizer is used to heat the liquid MB in order to speed up its

conversion to a gas. Once the gas is evenly distributed, it maintains that condition for the duration of the treatment unless an outside event such as excessive leakage occurs.

Section 18 Exemption Treatment Schedules

Methyl bromide fumigants, except those with “Q” labels, may be subject to requirements of the FIFRA Section 18 Quarantine Exemption. When commodities intended for food or feed are fumigated with methyl bromide under the FIFRA Section 18 Quarantine Exemption, one additional EPA requirement must be met: PPQ must monitor aeration by sampling the gas concentration to determine when a commodity may be released.

The EPA defines a Federal quarantine exemption (40 CFR 166.2(b)) as “A quarantine exemption may be authorized in an emergency condition to control the introduction or spread of any pest new to or **not** theretofore known to be widely prevalent or distributed within and throughout the United States and its territories.”

The Section 18 Exemption has been amended to permit treatment of commodities that are at risk for carrying Federal quarantine pests. This means that treatments are permitted not only for imported commodities, but also for domestic commodities growing in areas under quarantine for a regulated pest. This exemption does **not** authorize treatments of domestically grown commodities for export certification unless the treatment is necessary to move the commodity out of quarantine, i.e. the target pests must be Federally regulated pests.

In this manual, fumigation schedules under the FIFRA Section 18 Quarantine Exemption are followed by a “NOTICE” box to help you determine the current exemption status. For example:

Example Treatment Schedule					

NOTICE

Do not use this treatment schedule if its FIFRA Section 18 exemption has expired. For the current exemption status, contact your local State Plant Health Director (SPHD).

Table 2-3-1 is a list of commodities covered by the FIFRA Section 18 exemption. This list will expire on March 03, 2026.

Table 2-3-1 List of Commodities Covered by FIFRA Section 18 Exemption

Commodity	Minimum Temperature (°F)	Maximum Dosage Range (lb/1000 ft ³)	Exposure Period (hours)
Avocado	70	4	4
Banana and Plantain	40	4	2
Banana leaf	40	4	2
Blueberry and unlabeled commodities from the berry and small fruit crop group 13-07	40	4	4
Cacti, edible (includes <i>Opuntia</i>)	40	4	3.5
Citrus fruit (crop group 10)	40	3	2
Coffee bean (green, unroasted)	40	9	12
Coconut (unprocessed, whole coconut without husk)	60	2.5	2
Cottonseed (for animal feed)	40	7	24
	40	5	48
Cucurbit seed (unprocessed)	40	9	12
Dasheen (root and tuber)	40	4	4
Dragon fruit, Yellow dragon fruit (pitaya or pitahaya) ¹	40	4	2
Flowers, squash and loroco	40	4	2
Genip (Spanish lime)	40	4	4
Herbs and spices, fresh (crop group 19)	40	4	4
Ivy gourd	40	4	2
Kaffir lime leaves	40	4	2
Kola nut (cola)	40	6	6
Longan	40	4	2
Lychee fruit	40	4	2
Mango	40	4	2
Mint, dried	40	3	24
Mint, fresh	40	4	2
Oilseed (crop group 20)	40	9	12
Persimmon	40	4	2
Pomegranate, fresh	40	4	3
Pointed gourd	40	4	2
Rambutan	60	4	2
Seeds in the family Malvaceae for food use, including hibiscus and kenaf seed	40	3.5	2
Unlabeled commodities in the leaves of legume vegetable crop group 7 ²	40	4	2.5
Unlabeled commodities in the root and tuber crop group 1 ²	50	3	3.5

Table 2-3-1 List of Commodities Covered by FIFRA Section 18 Exemption (continued)

Commodity	Minimum Temperature (°F)	Maximum Dosage Range (lb/1000 ft3)	Exposure Period (hours)
Unlabeled commodities in the stone fruit crop group (12-12) ² (i.e., pluot, plumcot, aprium, cherrycot, peachcot)	40	4	3
Unlabeled commodities from the Bulb Vegetable Crop Group (3-07) ²	40	4	4
Unlabeled commodities in the stalk, stem, and leaf petiole crop group (22) ²	40	4	3.5
Unlabeled commodities in the following crop groups: ² ◆ <i>Brassica</i> leafy vegetables (crop group 5) ◆ <i>Cucurbit</i> vegetables (crop group 9) ◆ Edible podded legume vegetables (crop group 6A) ◆ Fruiting vegetable (crop group 8-10) ◆ Leafy vegetables (except <i>Brassica</i>) (crop group 4) ◆ Leaves of roots and tubers (i.e., chicory) (crop group 2) ◆ Tropical and subtropical fruit, edible peel (crop group 23) ◆ Tropical and subtropical fruit, inedible peel (crop group 24)	40	4	2

- 1 Refer to the document [Ecuador Dragon Fruit, Yellow Dragon Fruit, Pitahaya, Pitaya Fruit Admissible into Continental United States](#) for more information.
- 2 The EPA crop groups are listed in [Appendix F](#) on page [F-1-1](#) for quick reference. Refer to [40 CFR 180.41 Crop Group Tables](#) for the official list of commodities within each crop group. All commodities included in the EPA sub-groups of each EPA crop group are also eligible for the FIFRA Section 18 exemption fumigation.

The EPA only authorizes fumigation of commodities if they are listed on the label of the gas being used for the fumigation. The fumigator is responsible for ensuring that the commodity, its dosage, and the treatment duration is listed either on the product label or within the Section 18 authorization letter, which the PPQ officer should have readily available for any fumigator who requests it. The methyl bromide products that fumigators are authorized to use for Section 18 treatments are identified within the Section 18 authorization letter. To comply with State requirements, the fumigator is responsible for ensuring that the fumigant is registered in the State where it is being used.

Fumigation schedules in this publication are more detailed than what is provided in commercial labels in order to ensure that the phytosanitary treatments of imported commodities are efficacious.

When the treatment schedule is marked "MB", **any** methyl bromide fumigant may be used for the fumigation as long as the commodity, its dosage, and treatment duration are on the fumigant label.

Leak Detection and Gas Analysis

Require the fumigator to use an APHIS-approved gas detection device to measure gas concentration levels in tarpaulins. Require the fumigator to use an APHIS-approved leak detection device primarily to check for leaks around tarpaulins, chambers, application equipment, and as a safety device around the fumigation site. For a partial list of manufacturers of detection devices, refer to [Reference Guide to Commercial Suppliers of Treatment and Related Safety Equipment](#) on page E-1-1. Colorimetric tubes, which are supplied by the fumigator, are used to measure gas concentration levels during aeration.

2016 Methyl Bromide Label Information

In 2015, the Environmental Protection Agency (EPA) directed all methyl bromide (MB) registrants to amend the use directions on the labels of all 100% MB products. EPA required the changes in order to reflect recommendations in an EPA report.¹

These amendments modify the use directions for fumigation and aeration procedures, modify respiratory requirements and equipment and update gas monitoring equipment. EPA requires all labels on newly manufactured MB to reflect these recommendations effective **October 01, 2016**; however, EPA is allowing existing stocks of MB to be used in accordance with the use directions on the existing stock's (older) labels.

PPQ officials and fumigators **must** closely examine gas cylinder labels in order to validate that the dosage, exposure, and commodity are either on the cylinder label or covered by a FIFRA Section 18 exemption. If a label is **not** affixed to the cylinder, **DO NOT** allow the fumigator to use that cylinder.

¹ "Report of Food Quality Protection Act (FQPA) Tolerance Reassessment and Risk Management Decision (TRED) for methyl bromide, and Reregistration Eligibility Decision (RED) for Methyl Bromide's Commodity Uses", archive dated August 2006.

New Buffer Zone Requirements

All 2016 MB labels now require both a treatment and an aeration buffer zone. Both the treatment and aeration buffer zones are specific to the enclosure being fumigated and must be determined by tables in the [Environmental Protection Agency \(EPA\) Methyl Bromide Commodity Fumigation Buffer Zone Lookup Tables](#). The fumigators are responsible for using this website to determine the buffer zones and reporting both buffer zones to the PPQ official. If the treatment buffer zone is determined to be less than 30 feet, the PPQ official will maintain PPQ’s standard 30 foot treatment buffer zone; otherwise, the new treatment buffer zone **must** be observed. If the aeration buffer zone is determined to be less than 200 feet, then PPQ’s standard “200 feet for 10 minutes” aeration buffer zone **still** applies for the first 10 minutes of aeration. The fumigator **must** refer to EPA’s website to determine the minimum aeration buffer zone to be maintained until the aeration period is complete and the fumigator has verified that gas concentration levels meet the conditions in the MB label.

Transiting through buffer zones

The label permits vehicles to transit through both treatment and aeration buffer zones under specific conditions found in the label; it is up to the fumigator determine how or whether vehicles may transit in accordance with the label.

When using the newer 2016 MB label, changes to certain procedures and equipment in this chapter are displayed in a NOTICE box with a heading titled “MB 2016 Label”.

MB 2016 Label (example)

NOTICE

Use this information when the fumigator is using the 2016 MB label.

When using existing stocks, follow the equipment and procedural guidance that is displayed in the **body** of the text (**outside** of the NOTICE box).

If there is no “MB 2016 Label” NOTICE box, then the instructions apply to all MB labels, 2016 and older.

MB 2016 Label

NOTICE

The PPQ official and the fumigator must use the following leak detection and gas analysis equipment:

- ◆ An air purifying NIOSH certified half-mask or full face piece respirator when gas concentrations are between 1 and 5 ppm
- ◆ A self contained breathing apparatus (SCBA) NIOSH approved prefix TC-13F when gas concentrations are 5 ppm or above
- ◆ An APHIS-approved continuous real time gas monitoring device that is permanently mounted in PPQ owned facilities or a portable photoionization detector to monitor gas concentrations in the breathing space
- ◆ An APHIS-approved direct read gas detection device, such as colorimetric tubes, to determine gas concentrations when aerating and releasing the commodity

For a list of manufacturers and approved models refer to Reference Guide to Commercial Suppliers of Treatment and Related Safety Equipment.

PPQ policy is to wear appropriate respiratory protection when air concentrations are above 1 ppm. However, the new MB labels allow workers to be present **without** respiratory protection for specific time limits over a 24-hour period when air concentrations are: >3 to 5 ppm (90 minutes),

- ◆ >2 to 3 ppm (160 minutes),
- ◆ >1 to 2 ppm (4 hours), and
- ◆ >0 to 1 ppm (8 hours).

These permissible work-time allowances will give the PPQ official sufficient time to calmly locate and don the appropriate respiratory protection should their PID (alarm set to go off at 1 ppm) indicate the presence of MB in the air.

Effects of Temperature and Humidity

MB is effective at the same temperatures plants are generally handled (usually 40 °F and above). In general, increases in temperature give a corresponding increase in the effectiveness of MB. All treatment schedule temperatures are listed with the corresponding dosage rate. Follow the dosage rates listed. A Federal Insecticide, Fungicide, and Rodenticide Act (FIFRA) Section 3 registration (the labeled rate of MB provided), or a Section 18 Exemption **must** be in effect at the time of treatment.

For live plant material which is actively growing or with leaves, maintain a high percentage of humidity (above 75 percent) in the chamber by placing wet sphagnum or excelsior in the chamber or by wetting the chamber walls and floor. Protect actively growing or delicate plants from the direct air flow of fans. Do **not** add any moisture to the chamber when fumigating seeds. Too much moisture on the material to be fumigated may prevent the fumigant from reaching some of the pests.

Packaging Materials Approved for Fumigation

Plastic wrappings such as cellophane, films, and shrink wrap, and papers that are waxed, laminated, or waterproofed are **not** readily permeable and **must** be perforated, removed, or opened before fumigation. Approved packaging materials may be layered as long as perforations allow adequate MB penetration.

NOTICE

PPQ is **not** responsible for opening or perforating the wrapping.

Packaging is considered either “routine” or “non-routine”. Routine packaging does **not** require S&T approval. Routine packaging is packaging that can be visually confirmed that it meets one of the following criteria:

- ◆ Dry cloth
- ◆ Dry, non-waxed or non-painted cardboard
- ◆ Dry, non-waxed or non-painted, non-glossy paper
- ◆ Dry, woven fabrics and plastics
 - ❖ Woven polypropylene bags that are not laminated with plastic or paper inside or out (these bags are typically used for holding seeds or grains)
 - ❖ Bags containing large quantity of seeds or grains (>2,000 lbs.) are referred to as “super sacks” or “totes” and must have the top of the bag opened to aid in fumigant dispersal and aeration

- ◆ Perforated plastics with evenly distributed holes on all sides and 0.93 percent open area of surface, for example:
 - ❖ Holes that are 3/16-inch in diameter every 3 square inches
 - ❖ Holes that are 1/4-inch in diameter every 4 square inches
 - ❖ 49+ pinholes per square inch
- ◆ Plastic clamshells
 - ❖ Evenly distributed holes on all sides and 0.93 percent open area of surface
 - ❖ Holes on top and bottom **must not** be blocked when clamshells are stacked (i.e., clamshells **must** have recesses or ridges to prevent blockage)
- ◆ Wooden boxes (lids removed if tightly sealed)

Non-routine packaging **must** be approved by S&T. Contact ppqmt@usda.gov for specifications for approval. Refer to [Packaging—Non-Routine USDA-Approved For Fumigation](#) on page E-28 for a list of approved non-routine packaging manufacturers.

If the commodity is undergoing fumigation, the consignment **can** be rejected because of packaging.

NOTICE

Inform prospective importers that the wrappings on their shipments may have to be perforated according to PPQ specifications, removed, or opened if PPQ requires fumigation.

To expedite commodity movement, importers should send a complete bag/wrap sample to S&T-TMT for approval.

USDA-APHIS-PPQ-S&T-TMT
13601 Old Cutler Road, Bldg. 63
Miami, FL 33158 USA
Phone: 305-278-4877
Email: ppqmt@usda.gov

Sorption

Sorption is the process of chemically or physically binding free MB on or within the fumigated commodity. Sorption makes the fumigant unavailable to kill the plant pest. There are three types of sorption—absorption, adsorption, and chemisorption. Sorption rate is high at first, then gradually reduces to a slow rate. Sorption increases the time required for aeration.

Commodities known or believed to be highly sorptive should **not** be fumigated in chambers unless concentration readings can be taken to ensure the required minimum concentration is met. Additional readings may be necessary in order to properly monitor gas concentration sorptive commodities in chambers.

For tarpaulin fumigation, additional gas readings are necessary to monitor concentration of gas to determine the rate of sorption. The following is a partial list of commodities known to be highly sorptive:

- ◆ Burlap bales
- ◆ Carpet backing
- ◆ Cinnamon quills
- ◆ Cocoa mats
- ◆ Cotton
- ◆ Flour and finely milled products
- ◆ Gall nuts
- ◆ Hardboard (Masonite™)
- ◆ Incense
- ◆ Myrobalan
- ◆ Pistachio nuts
- ◆ Polyamide waste
- ◆ Polystyrene foam (Styrofoam)
- ◆ Potato starch
- ◆ Rubber (crepe or crude)
- ◆ Vermiculite
- ◆ Wood products (unfinished)
- ◆ Wool (raw, **except** pulled)

Contact S&T-TMT if you are concerned about the sorptive properties of other commodities.

Residual Effect

MB may adversely affect the shelf life of fresh fruits and vegetables, the viability of dormant and actively growing plants, and the germination of seed. Although MB may adversely affect some commodities, it is a necessary risk in order to control pests. Some dosage rates are near the maximum tolerance of the commodity, so care **must** be exercised in choosing the proper treatment schedule and applying the treatment.

MB may also adversely affect nonplant products. In general, articles with a high sulfur content may develop “off-odors” on contact with MB. In some commodities the odors are difficult or impossible to remove by aeration. If possible or practical, remove from the area to be fumigated any items that are likely to develop an undesirable odor.

The following items should **not** be fumigated:

- ◆ Any commodity **not** listed on the label or lacking a FIFRA Section 18 exemption
- ◆ Any commodity lacking a treatment schedule
- ◆ Automobiles
- ◆ Baking powder
- ◆ Blueprints
- ◆ Bone meal
- ◆ Butter, lard, or fats, unless in airtight containers
- ◆ Charcoal (highly sorptive)
- ◆ Cinder blocks or mixed concrete and cinder blocks
- ◆ CO² scrubbers² (calcium hydroxide and calcium carbonate; MAXtend®)
- ◆ EPDM rubber (ethylene propylene diene M-class; a type of synthetic rubber)
- ◆ Electronic equipment³
- ◆ Ethylene absorbers (potassium permanganate sachets used to remove ethylene from an enclosure, usually a container loaded with fruit)
- ◆ Feather pillows

² If the scrubbers are removed prior to fumigation, the consignment may be fumigated.

³ Electronic equipment may be fumigated, as long as it is properly sealed to protect against internal fluid contamination by the MB gas. Ensure that the liquid MB is completely volatilized before it is introduced into the area to be fumigated. Obtain a waiver from the importer agreeing to release the USDA from any damages.

- ◆ Felt
- ◆ Furs
- ◆ High-protein flours (soybean, whole wheat, peanut)
- ◆ Horsehair articles
- ◆ Leather goods
- ◆ Machinery with milled surfaces
- ◆ Magazines and newspapers (made of wood pulp)
- ◆ Magnesium articles (subject to corrosion)
- ◆ Paper with high rag or sulfur content
- ◆ Photographic chemicals and prints (**not** camera film or X-rays)
- ◆ Polyurethane foam
- ◆ Natural rubber goods, particularly sponge rubber, foam rubber, and reclaimed rubber including pillows, mattresses, rubber stamps, and upholstered furniture
- ◆ Neoprene
- ◆ Rug pads
- ◆ Silver polishing papers
- ◆ Woolens (especially angora), soft yarns, and sweaters; viscose rayon fabrics
- ◆ Yak rugs

Chemical Treatments

Fumigants—Methyl Bromide—Tarpaulin Fumigation

Contents

Methods and Procedures	2-4-1
2016 Methyl Bromide Label Information	2-4-2
Materials Needed	2-4-3
PPQ Official Provides	2-4-3
Fumigator Provides	2-4-4
Preparing to Fumigate	2-4-6
Conducting the Fumigation	2-4-27
Special Procedures for Adding Gas and Extending Exposure Period	2-4-33
Adding Gas and Extending Exposure Period to Commodities that are Fumigated Using Treatment Schedules Other Than T101-a-1 or Equivalent (may include perishables)	2-4-33
Adding Gas to Fruits, Vegetables, or Perishable Commodities Using Schedule T101-a-1 or Equivalent	2-4-34
Special Procedures for Adding Gas to Oak Logs Using T312-a or T312-a-Alternative	2-4-37
Aeration	2-4-38
Responsibility for Aerating the Commodity	2-4-38
Aeration Buffer Zones	2-4-39
Wearing Respiratory Protection	2-4-39
Aerating Nonsorptive, Containerized Cargo—Indoors and Outdoors	2-4-40
Aerating Nonsorptive, Noncontainerized Cargo—Indoors and Outdoors	2-4-41
Aeration Procedures for Fresh Fruits, Vegetables, and Cut Flowers—Indoors or Outdoors	2-4-43
Aerating Sorptive, Noncontainerized Cargo—Indoors and Outdoors	2-4-45
Aerating Sorptive Commodities in Containers—Indoors and Outdoors	2-4-47

Methods and Procedures

The procedures in this section provide PPQ officials and commercial fumigators with the methods, responsibilities, and precautions for tarpaulin fumigations.

2016 Methyl Bromide Label Information

In 2015, the Environmental Protection Agency (EPA) directed all methyl bromide (MB) registrants to amend the use directions on the labels of all 100% MB products. EPA required the changes in order to reflect recommendations in an EPA report.¹

These amendments modify the use directions for fumigation and aeration procedures, modify respiratory requirements and equipment and update gas monitoring equipment. EPA requires all labels on newly manufactured MB to reflect these recommendations effective **October 01, 2016**; however, EPA is allowing existing stocks of MB to be used in accordance with the use directions on the existing stock's (older) labels.

PPQ officials and fumigators **must** closely examine gas cylinder labels in order to validate that the dosage, exposure, and commodity are either on the cylinder label or covered by a FIFRA Section 18 exemption. If a label is **not** affixed to the cylinder, **DO NOT** allow the fumigator to use that cylinder.

New Buffer Zone Requirements

All 2016 MB labels now require both a treatment and an aeration buffer zone. Both the treatment and aeration buffer zones are specific to the enclosure being fumigated and must be determined by tables in the [Environmental Protection Agency \(EPA\) Methyl Bromide Commodity Fumigation Buffer Zone Lookup Tables](#). The fumigators are responsible for using this website to determine the buffer zones and reporting both buffer zones to the PPQ official. If the treatment buffer zone is determined to be less than 30 feet, the PPQ official will maintain PPQ's standard 30 foot treatment buffer zone; otherwise, the new treatment buffer zone **must** be observed. If the aeration buffer zone is determined to be less than 200 feet, then PPQ's standard "200 feet for 10 minutes" aeration buffer zone **still** applies for the first 10 minutes of aeration. The fumigator **must** refer to EPA's website to determine the minimum aeration buffer zone to be maintained until the aeration period is complete and the fumigator has verified that gas concentration levels meet the conditions in the MB label.

Transiting through buffer zones

The label permits vehicles to transit through both treatment and aeration buffer zones under specific conditions found in the label; it is up to the fumigator determine how or whether vehicles may transit in accordance with the label.

¹ "Report of Food Quality Protection Act (FQPA) Tolerance Reassessment and Risk Management Decision (TRED) for methyl bromide, and Reregistration Eligibility Decision (RED) for Methyl Bromide's Commodity Uses", archive dated August 2006.

When using the newer 2016 MB label, changes to certain procedures and equipment in this chapter are displayed in a NOTICE box with a heading titled “MB 2016 Label”.

MB 2016 Label (example)

NOTICE

Use this information when the fumigator is using the 2016 MB label.

When using existing stocks, follow the equipment and procedural guidance that is displayed in the **body** of the text (**outside** of the NOTICE box).

If there is no “MB 2016 Label” NOTICE box, then the instructions apply to all MB labels, 2016 and older.

Materials Needed

PPQ Official Provides

- ◆ APHIS-approved leak detection device
- ◆ Calculator (optional)
- ◆ Forms (PPQ Form 429A and APHIS Form 2061, if necessary)
- ◆ Self-contained breathing apparatus (SCBA) or supplied air respirator

MB 2016 Label

NOTICE

In addition to the bulleted equipment list required from PPQ, PPQ must also provide:

- ◆ Air purifying respirator NIOSH certified half-mask or full face piece with a cartridge for concentrations between 1 and 4 ppm
- ◆ APHIS-approved continuous real time gas monitoring device
 - ❖ Permanently mounted in PPQ owned facilities only, PureAire Monitoring Systems, Inc., model Air Check Advantage. The Air Check Advantage can be calibrated either by the manufacturer or by the PPQ official. Calibrate according to the manufacturer's User Guide. Refer to Chapter 8: Equipment for more information.
 - ❖ Portable Photoionization Detector (PID), RAE Systems, Inc. model MiniRAE 3000. The MiniRAE 3000 must be calibrated by the PPQ official according to the manufacturer's User Guide. Refer to Chapter 8: Equipment for more information.
- ◆ Self contained breathing apparatus (SCBA) NIOSH approval prefix TC-13F or supplied air respirator NIOSH approval prefix TC-19C

Fumigator Provides

- ◆ APHIS-approved gas detection device² (e.g. thermal conductivity (TC) analyzer, infrared device, etc.)
- ◆ Auxiliary pump for purging long gas sample tubes
- ◆ Carbon dioxide filter (e.g., Ascarite[®])
- ◆ Colorimetric tubes (Refer to [Appendix E](#) for a list of APHIS-approved product ranges)
- ◆ Desiccant (Drierite[®])
- ◆ Electrical wiring (grounded, permanent type), three prong extension cords
- ◆ Exhaust blower and ducts
- ◆ Fans (circulation, exhaust, and introduction)
- ◆ Framework and supports
- ◆ Gas introduction line

² The MB monitor must be calibrated annually. Refer to Chapter 8: Equipment for calibration information. If using a TC analyzer, Drierite and Ascarite must be used.

- ◆ Gas sampling tubes
- ◆ Heat supply
- ◆ Insecticides and spray equipment
- ◆ Loose, wet sand
- ◆ Methyl bromide
- ◆ Padding
- ◆ Sand or water snakes or adhesive sealer
- ◆ Scales or dispensers³
- ◆ Self-contained breathing apparatus (SCBA) or supplied air respirator
- ◆ Tape
- ◆ Tape measure
- ◆ Tarpaulin
- ◆ Temperature recorder and temperature sensors⁴
- ◆ Thermometer⁵
- ◆ Volatilizer (filled with water or antifreeze)
- ◆ Warning signs/Placarding

3 All scales **must** be calibrated by the State, a company that is certified to conduct scale calibrations, or by the fumigator under the supervision of PPQ. The source and date of calibration **must** be posted in a visible location on or with the scale at all times. The scale **must** be calibrated following every repair or a minimum of every year.

4 Temperature sensors **must** be calibrated annually by the manufacturer or National Institute of Standards and Technology (NIST) within the range of 40 °F to 80 °F (4.4 °C to 26.7 °C).

5 The thermometer **must** be calibrated or replaced annually.

MB 2016 Label

NOTICE

In addition to the bulleted equipment list required from the fumigator, the fumigator must also provide:

- ◆ Air purifying respirator NIOSH certified half-mask or full face piece with a cartridge for concentrations between 1 and 4 ppm
- ◆ APHIS-approved direct read gas detection device
 - ❖ Colorimetric tubes (e.g. Draeger, Sensidyne)
- ◆ APHIS-approved continuous real time gas monitoring device
 - ❖ Permanently mounted in PPQ owned facilities only, PureAire Monitoring Systems, Inc., model Air Check Advantage
 - ❖ Portable Photoionization Detector (PID), RAE Systems, Inc. model MiniRAE 3000
 - ❖ Devices **must** be calibrated according to the manufacturer's User Guide. Refer to Chapter 8: Equipment for more information.
- ◆ Self contained breathing apparatus (SCBA) NIOSH approval prefix TC-13F or supplied air respirator NIOSH approval prefix TC-19C

Preparing to Fumigate

Step 1: Selecting a Treatment Schedule

The PPQ official will select a treatment schedule to effectively eliminate the plant pest.

Turn to the Treatment Schedule Index and look up the available treatment schedule(s) by commodity (example—apples, pears, or citrus) or by pest (e.g., Mediterranean fruit fly). Some commodities may have several treatment schedules. Refer to [Residual Effect](#) on page 2-3-11 for a list of those commodities which may be damaged by MB. Each treatment schedule lists the target pest or pest group (e.g., *Ceratitidis capitata*, surface feeders, wood borers), commodity, or both pest and commodity. If there is **no** schedule, the commodity may **not** be fumigated. Refer to [Table 2-3-1](#) on page 2-3-3 to determine if a schedule is available under a FIFRA Section 18 Exemption. If a treatment is required, go to [Table 2-4-1](#).

Table 2-4-1 Determine Reporting Requirements

If a Treatment is Required:	Then:
As a result of a pest interception	GO to Step 2
As a condition of entry	GO to Step 3

Step 2: Issuing a PPQ Form 523 (Emergency Action Notification)

When an intercepted pest is identified and confirmed by a PPQ Area Identifier as requiring action, the CBP or PPQ official will issue a PPQ Form 523 (Emergency Action Notification - EAN) to the owner, broker, or representative. The EAN will list all treatment options. Follow instructions in Appendix A for completing and distributing the PPQ Form 523.

Step 3: Determining Section 18 Exemptions and Sampling Requirements

After selecting the treatment schedule, the PPQ official will be able to determine which treatment schedules are FIFRA Section 18 Exemptions. The schedule will be followed by a “NOTICE” box to help identify the current exemption status. Some treatment schedules are only FIFRA Section 18 Exemptions at specific temperature ranges. Check the treatment schedule and temperature to determine if the fumigation will be a FIFRA Section 18 Exemption. Refer to [Table 2-3-1](#) on page [2-3-3](#) to determine if a schedule is available under a FIFRA Section 18 Exemption.

Step 4: Selecting a Fumigation Site

The PPQ official and the fumigator **must** consider the following factors in selecting a fumigation site:

- ◆ Ability to heat (in colder areas)
- ◆ Aeration requirements
- ◆ Electrical power supply
- ◆ Impervious surface
- ◆ Multiple fumigation buffer zone overlap
- ◆ Nonwork area that can be effectively marked and safeguarded or isolated
- ◆ Water supply
- ◆ Well-lighted area
- ◆ Well-ventilated, sheltered area

Well-Ventilated, Sheltered Area

The PPQ official and the fumigator **must** select sites that are well-ventilated and sheltered. A well-ventilated site is required for exhausting gas before and when the tarpaulin is removed from the stack. Most warehouses have high ceilings and a number of windows/doors which can be used for ventilation. Some gas will escape from the tarpaulin even in the best conditions. Avoid areas where strong drafts are likely to occur.

In warehouses, the fumigator **must** provide an exhaust system to exhaust MB to the outside of the building. The fumigator must ensure that the exhausted gas does **not** reenter the building nor endanger people working outdoors.

When treatments are conducted in a particular location on a regular basis, the PPQ official must ensure that the fumigator designates a permanent site. At such sites, the fan used to remove the fumigant from the enclosure during aeration **must** be connected to a permanent stack extending above the roof level.

If fumigations are conducted outside, ensure that the fumigator selects a site that is semi-sheltered such as the leeward side of a warehouse, pier, or building that offers some protection from severe winds. Severe winds are defined as sustained winds or gusts of 30 m.p.h. or higher for any time period. Do **not** allow the fumigator to proceed if there is a forecast from the National Weather Service of severe winds and/or thunderstorms at the beginning of, or for the entire length of, the fumigation.

Ability to Heat

When cooler temperatures (below 40 °F) are expected, the fumigator must ensure that the commodity temperatures are maintained above 40 °F. The PPQ official will take the ambient (air) temperature 12 inches above the floor.

For treatments lasting 6 hours or longer, temperatures **must** be maintained at or above the starting treatment temperature for the entire duration of the treatment. Additionally, the PPQ official **must** monitor the temperature of the enclosure using temperature sensors and a temperature recorder. The temperature recording system for treatments lasting 6 hours or longer must meet the following specifications:

- ◆ Accurate to within ± 0.6 °C or ± 1.0 °F in the treatment temperature range of 4.4 °C to 26.7 °C (40 °F to 80 °F)
- ◆ Calibrated annually by the National Institute of Standards and Technology (NIST) or by the manufacturer
 - ❖ The calibration certificate will list a correction factor, if needed, and the correction factor would be applied to the actual temperature reading to obtain the true temperature.

- ◆ Capable of printing all temperature readings or downloading data to a secure source once per hour throughout the entire treatment (all temperature data must be accessible at a safe distance during the fumigation)
- ◆ Tamper-proof

If one or more of the temperature readings go below the minimum temperature specified in the treatment schedule, the fumigation will be considered a failed treatment. The commodity must be re-treated, returned to the country of origin, reexported, or destroyed.

⚠ CAUTION

Commodities used for food or feed may not be re-treated. If commodities fall into this category, the only options are the following:

- ◆ Return to the country of origin
- ◆ Reexported to another country if they will accept the shipment
- ◆ Destroy by incineration

The PPQ official ensures that the fumigator places thermocouples evenly throughout the enclosure or container. The placement of the temperature sensors will vary depending on the item fumigated and the configuration of the fumigation site. Contact the USDA-APHIS-PPQ-S&T-TMT (305) 278-4877 for instructions regarding exact placement of the temperature sensors. Use [Table 2-4-2](#) to determine the number of temperature sensors needed based on size of the enclosure.

Table 2-4-2 Determine the Number of Temperature Sensors

Size of Enclosure (ft ³)	Number of Temperature Sensors
Up to 10,000	3
10,001-25,000	6
25,001-55,000	9
Larger than 55,000	12

NOTICE

Do **not** use flame or exposed electrical element heaters under the tarpaulin during treatment because MB may cause the formation of hydrogen bromide. Hydrogen bromide (hydrobromic acid) is a highly corrosive chemical which can cause damage to the heater and to surrounding materials, including the commodity. Hot air or radiator type heaters can be used for heating under tarpaulins. When using space heaters to heat warehouses, there **must** be adequate ventilation.

Impervious Surface

Select an asphalt, concrete, or tight wooden surface—**not** soil, gravel, or other porous material. If you **must** fumigate on a porous surface, require the fumigator to cover the surface with plastic tarpaulins. For large fumigations, covering the surface is **not** usually practical because pallets **must** be rearranged and heavy equipment used to move the commodity. On docks, wharfs, and piers, require the fumigator to seal cracks, holes, and manhole covers which will allow the MB to escape through the floor.

Nonwork Area

MB 2016 Label

NOTICE

The fumigator will determine the treatment buffer zone in accordance with the [Environmental Protection Agency \(EPA\) Methyl Bromide Commodity Fumigation Buffer Zone Lookup Tables](#).

The treatment buffer zone surrounds the area where access is limited during treatment. If the fumigator determines that the buffer zone is less than 30', then PPQ requires a 30' buffer zone. If the fumigator determines that the buffer zone is greater than 30', then PPQ must observe the prescribed buffer zone.

The treatment buffer zone extends from the perimeter of the enclosure to a distance determined by the fumigator in accordance with the label. Entry by any person except the PPQ official and the fumigator is prohibited except as provided in the "Exceptions to Buffer Zone Entry Restrictions" section of the label.

The treatment buffer zone begins when the fumigant is introduced into the enclosure and ends when aeration begins, at which point the aeration buffer zone requirements apply.

The fumigator must define treatment and aeration buffer zone perimeters using physical barriers (such as walls, ropes, etc.) and placards to limit access to the buffer zone. Placards must meet all label requirements regarding specific warnings, information, and language.

The fumigator will permit transiting through buffer zones in accordance with the "Transit Exception" section of the label.

Buffer Zone Overlap for Multiple Enclosures

For multiple enclosures where buffer zones overlap, the fumigator must recalculate both the treatment and aeration buffer zones in accordance with the label and supply them to the PPQ official.

Nonwork Area

The PPQ official and the fumigator **must** select a secure area where traffic and people are restricted from entering and which is isolated from people working. A nonwork area is preferred to help prevent accidents, such as a forklift piercing a tarpaulin. The fumigation area is the area 30 feet surrounding the tarpaulin and is separated from the non-fumigation area by a physical barrier such as ropes, barricades, or walls. If a wall of gas-impervious material is less than 30 feet from the tarpaulin, the wall may serve as the edge of the secured area. The fumigator must placard within the perimeter of the secured area. Placards **must** meet label requirements regarding specific warnings, information, and language. Placards generally include the name of the fumigant, the fumigation date, time, and the name of the company conducting the fumigation. The fumigator must restrict access to the fumigation area to the fumigator's employees and PPQ employees monitoring the treatment. Use rope or marker tape to limit access within 30 feet of the enclosure. Unless you (PPQ) authorize their use, do **not** allow motor vehicles (includes forklifts) to operate within 30 feet of the enclosure and aeration area during the fumigation and aeration periods. The area outside the 30-foot perimeter is usually regarded as a safe distance from the tarpaulin. Gas concentrations exceeding 5.0 ppm (TLV for MB) are seldom recorded by gas monitoring, **except** during aeration. The 30-foot perimeter is **not** specifically mentioned on the MB label, but is required for PPQ supervised fumigations. When space is tight, it is permissible to overlap two adjoining 30-foot perimeters. When multiple fumigations are occurring simultaneously, there **must** be sufficient space for a person wearing SCBA to walk between the tarpaulins.

Electrical Power Supply

An adequate electrical source **must** be available to run the circulation fans and the gas detection device. A separate line should be available for the gas detection device. Electrical outlets **must** be grounded and conveniently located in relation to the fumigation area. PPQ does not allow generators as a power source except under emergency conditions.

Water Supply

A water supply is necessary for safety purposes. Water is necessary for washing off MB if the liquid form is spilled on someone. If **no** permanent water is present on site, the fumigator **must** provide a 5-gallon supply of potable, unfrozen water.

Well-Lighted Areas

The fumigator will ensure that the area has adequate lighting for safety purposes and for reading gas detection devices, thermometers, and determining whether the tarpaulin has holes or tears.

Aeration Requirements

The fumigator is responsible for all aspects of aeration. When the fumigation is a Section 18 exemption fumigation, the PPQ official is required to verify the final gas concentration reading(s). Refer to [Aeration](#) on page 2-4-38 for more information.

Step 5: Arranging the Stack

Break Bulk Cargo

Ensure that the fumigator arranges the cargo in a square or rectangular shape, if possible, to make it easy to cover and to calculate the volume of the stack. An even shaped stack is easy to tarp. The height of the stack should be uniform so dosage can be calculated accurately. For loose cargo, the tarpaulin should be 2 feet above the load and 1 foot from the sides and ends. Unless specified in the treatment schedule, cargo should **not** exceed two-thirds of the volume of the area to be fumigated. Contact S&T-TMT for approval for any enclosure larger than 25,000 ft³. For large enclosures, it may be necessary to:

- ◆ Add more sampling tubes
- ◆ Install extra circulation fans
- ◆ Introduce the fumigant at several sites, using multiple volatilizers
- ◆ Run the circulation fans longer than the first 30 minutes if the difference between the highest and lowest gas concentration readings exceeds four ounces

Once S&T-TMT has approved the site and enclosure, it does **not** require additional approvals for subsequent fumigations. The PPQ official **must** ensure that the commodity is on pallets to permit air movement along the floor and between the cargo. Allow an inch or more of space between pallets. By arranging the stack evenly and with space between pallets or cartons, the fumigant will be effectively distributed and dosage calculation should be easier and more accurate. Dosages are easier to calculate when the dimensions are uniform.

When the fumigation involves multiple stacks, PPQ will ensure that the fumigator allows 10 feet of space between each uncovered stack. After the stack is tarped, there should be approximately 5 feet between enclosures.

Containerized Cargo

Ensure that the fumigator places **no** more than eight containers that are 20 to 40 feet in length under a single tarpaulin. APHIS does **not** allow containers to be stacked. Stacking may create too great a safety risk to the person placing the tarp, fans, and gas monitoring leads. If fumigating multiple containers in a single row, ensure that the fumigator has all the doors opening on a center aisle toward each other (see [Figure 2-4-1](#) on page 2-4-14). The aisle **must** be at least 3 feet wide. Open all doors completely, if possible.

However, APHIS will allow fumigation of containerized cargo with one door open on each container using a configuration such as the one shown in [Figure 2-4-2](#) on page 2-4-14, or in a single row of eight containers. Require the fumigator to introduce gas at both ends of this long row configuration, either at the same time or half at one end and half at the other end. In any case, the single open door on each container **must** be kept from closing during the fumigation, either taped or blocked open.

CAUTION

APHIS recommends that perishable commodities be fumigated outside their containers, but does allow fumigation inside the container. Because it is difficult to aerate the container, the commodity may be damaged by the fumigant if left in the container. When a commodity is removed from the container, spray the empty container according to [T402-d Pests: Miscellaneous Hitchhiking Insects \(E.g., Crickets, Scarab Beetles, Ants, Africanized Honeybee Swarms, Spotted Lanternfly\)](#) as a precaution against hitchhiking pests.

To conserve MB use, S&T-TMT recommends that containers be removed from their chassis prior to fumigation. If this is **not** done, then the space beneath the container **must** be calculated as part of the total volume being fumigated.

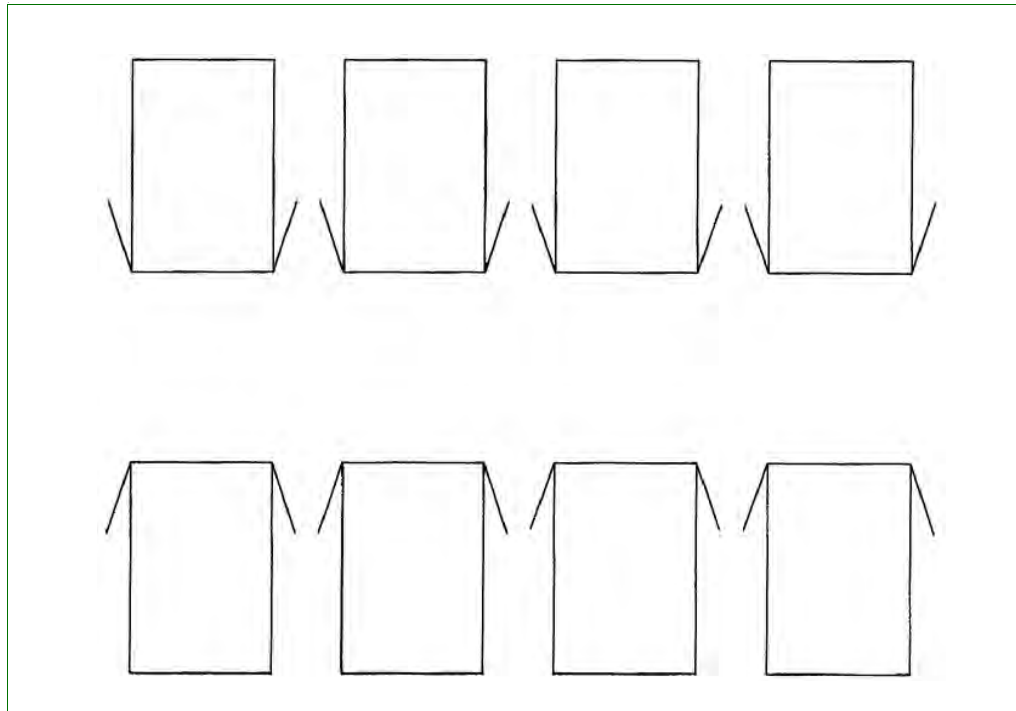

Figure 2-4-1 Container Arrangement in Two Rows with Both Doors Open

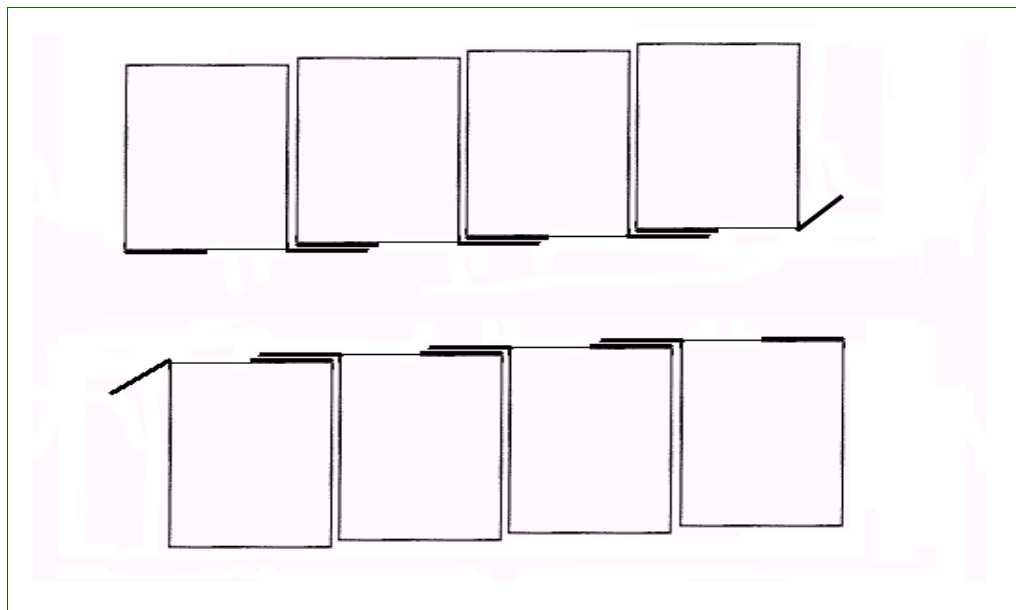

Figure 2-4-2 Container Arrangement in Two Rows With One Door Open

If fumigating multiple containers in a single row, require the fumigator to open the rear doors on the same side of the stack. If containers are parked parallel to one another and close together, it is permissible to open only the door on the right side of each container, overlapping and taped to the closed left door of the container adjacent to it. If containers are **not** parked closely together, all doors **must** be completely open.

Ensure that containers are **not** loaded beyond 80 percent of their capacity. Ensure that bulk commodities are placed in boxes or containers on pallets. The pallets **must** be loaded in the container so that there is at least 2 inches of space under the commodity and between each pallet. There must be a minimum of 18 inches above the commodity. This facilitates uniform gas distribution and allows a crawl space for placing the gas sampling tubes and fans. (Some restacking of cargo may be necessary to meet this requirement.) If the container is tarped, **no** additional head space is required between the roof of the container and the tarp, unless the pest is found on the outside of the container.

Gas Penetration and Distribution

MB will penetrate most cargo easily. Penetration is enhanced by the availability of free MB.

All packaging used in USDA quarantine fumigations must comply with the standards in [Packaging Materials Approved for Fumigation](#) on page 2-3-8. Some of the more common types of impermeable materials are cellophane, plastic, wax coated materials, laminated, and waterproofed papers. Tight wooden packing cases are also relatively gas tight. Impermeable materials will allow some gas to penetrate, but make it difficult to aerate and evacuate the gas. Require the fumigator to remove, perforate, or open all impermeable materials.

Step 6: Arranging and Operating Fans

Break Bulk Cargo

Require the fumigator to use fans which have the capacity to move a volume in cubic feet per minute equivalent to the total volume of the enclosure. Refer to [Table 2-4-3](#) to determine the number and placement of fans.

Table 2-4-3 Determining Number and Placement of Circulation Fans for Tarpaulin Break Bulk Cargo

Volume of Enclosure (ft ³)	Number of 2,500 CFM Fans (2 axial-type blade)	Require the fumigator to place the fans:
5,000	2	<ol style="list-style-type: none"> 1. On the floor at the rear of the stack facing the front 2. At the top front (MB introduction site) facing the rear
5,001-7,500	3	<ol style="list-style-type: none"> 1. On the floor at the rear of the stack facing the front 2. At the top front (MB introduction site) facing the rear 3. Upper middle facing the rear
7,501-10,000	4	<ol style="list-style-type: none"> 1. On the floor at the rear of the stack facing the front 2. At the top front (MB introduction site) facing the rear 3. Upper middle facing the rear 4. On the floor near the middle facing the front
10,001-25,000	5-7	<ol style="list-style-type: none"> 1. On the floor at the rear of the stack facing the front 2. At the top front (MB introduction site) facing the rear 3. Upper middle facing the rear 4. On the floor near the middle facing the front 5. Various locations
> 25,000	Consult S&T-TMT	

Require the fumigator to turn on all fans to make sure they work. The fans must be operated during gas introduction and for 30 minutes after the gas is introduced. If after taking gas concentration readings the fumigant is **not** evenly distributed (as indicated by concentration readings within 4 oz. of each other), require the fumigator to run the fans until the gas is evenly distributed. Require the fumigator to run fans when adding gas, but only long enough to obtain even gas distribution.

Containerized Cargo

Require the fumigator to use an appropriate number of fans which have the capacity to move the equivalent cubic feet per minute of the total volume of the enclosure. Use two fans in the container to circulate the gas. Place one fan of at least 2,500 cfm at the top of the load (near door) of each container facing the opposite end of the container. Place the second fan on top of the load facing the door.

Require the fumigator to place air introduction ducts for aeration into the far ends of each container opposite the doors and to place exhaust ducts on the ground in front of the doors of the containers. The fumigator must place the end of the ducts near the edge of the tarpaulin so they can be pulled under the tarpaulin when aeration begins.

Step 7: Placing the Gas Introduction Lines

MB is converted from a liquid into a gas by a volatilizer. Ensure that the line that runs from the MB cylinder into the volatilizer is 3,000 PSI hydraulic high pressure hose with a 3/8 inch interior diameter (I.D.) or larger. From the volatilizer, MB gas is introduced into the structure by means of a gas introduction line. The gas introduction line **must** be a minimum of 350 PSI with a 1/2 inch I.D. or larger.

Break Bulk Cargo

Ensure that the fumigator places the gas introduction line directly above the upper front fan and attaches the line to the top of the fan to prevent movement. An unsecured introduction line could tear the tarpaulin, move the line, or direct it out of the airflow. Require the fumigator to attach the fan firmly to the cargo or have a base that prevents it from toppling (**not** a pedestal type). Require the fumigator to place a piece of impermeable sheeting over the commodity and to the front of each gas supply line. The sheet will prevent any liquid MB from coming in contact with the cargo.

Containerized Cargo

The number and placement of gas introduction lines depend on the number and arrangement of containers to be fumigated.

For single containers, ensure that the fumigator installs the introduction line directly above the fan near the door of the container.

For multiple containers, ensure that the fumigator places the appropriate number of introduction lines to ensure even gas distribution.

If you are fumigating five or more containers under one tarpaulin, then require the fumigator to use a minimum of two gas introduction lines to ensure even gas distribution.

Step 8: Placing the Gas Sampling Tubes

Break Bulk Cargo

Ensure that the fumigator installs a minimum of three gas sampling tubes for fumigations up to 10,000 ft³ positioned in the following locations (refer to [Figure 2-4-3](#)):

- ◆ Front low—front of the load, 3 inches above the floor
- ◆ Middle center—center of the load, midway from bottom to top of the load
- ◆ Rear high—rear of the load, at the extreme top of the load

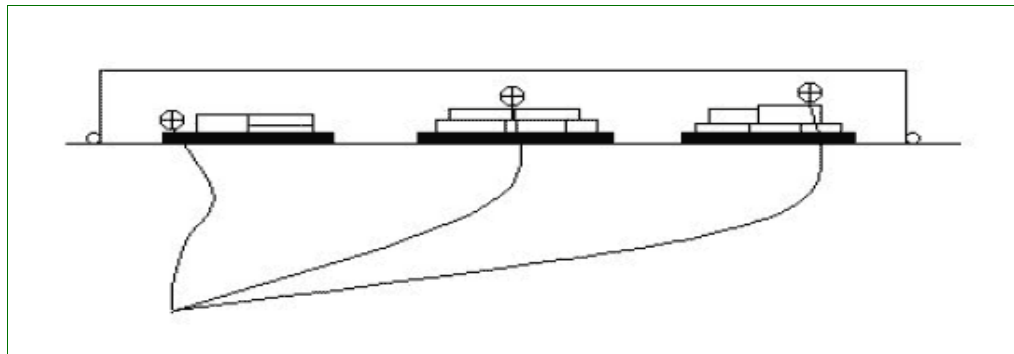

Figure 2-4-3 Example of the Position of Gas Sampling Tubes (Side View)

For fumigations from 10,001 to 25,000 ft³, require the fumigator to use six gas sampling tubes, positioned in the following locations:

- ◆ Front low—front of the load, 3 inches above the floor
- ◆ Upper front quarter section
- ◆ Middle center—center of the stack, midway from bottom to top
- ◆ Upper rear quarter section
- ◆ Lower rear quarter section
- ◆ Rear high—rear of the stack, at the extreme top

The PPQ official must contact S&T-TMT for approval of fumigations larger than 25,000 ft³, for instructions for number of gas sampling tubes, and for other technical information.

NOTICE

For Khapra beetle cargo containing baled, packaged, finely milled, or closely packed commodities, require the fumigator to place two additional gas sampling tubes in the center of the bags, packages, or bales. Before placing gas sampling tubes in commodities, require the fumigator to place burlap over the end of the tube and secure the burlap to the tube with tape.

Containerized Cargo

For all containers (either 20 or 40 feet in length) under the same tarpaulin, require the fumigator to use at least three tubes per container, positioned as follows:

- ◆ Front low—near the floor at the door end of the container
- ◆ Middle center—rear of the load at the high end opposite the fan
- ◆ Rear high—midway from front to back, at mid-depth

If treating commodities for khapra beetle, require the fumigator to install the following additional gas sampling tubes:

- ◆ High (in the commodity)
- ◆ Low (in the commodity)

Require the fumigator to cover the end of the gas sampling tube with burlap taped to the tube before inserting into the commodity.

Break Bulk and Containerized Cargo

Require the fumigator to use gas sampling tubes of sufficient length to extend from the sampling position inside the enclosure to at least 30 feet beyond the tarpaulin. Ensure that all the gas sampling tubes meet in one area for ease and safety in taking gas concentration readings. Do **not** permit gas sampling tubes to be spliced. Before starting the fumigation, check for gas sampling tube blockage or pinching by connecting each tube to a MityVac hand pump or to the gas detection device for a short time. If the tube is blocked, the flow to the device will drop sharply. Require the fumigator to replace any defective gas sampling tubes.

Require the fumigator to secure all gas sampling tubes in place under the tarpaulin and label each one at the end where the gas concentration readings will be taken. By labeling each gas sampling tube, you will be able to record concentration readings easily.

Step 9: Padding Corners

Ensure that the fumigator looks for corners and sharp angles which could tear the tarpaulin. **Do not allow** the fumigator to use commodity to support the tarpaulin. If the sharp angles or corners **cannot** be eliminated, the fumigator must cover them with burlap or other suitable padding (e.g., old tires or cloth) (see [Figure 2-4-4](#)).

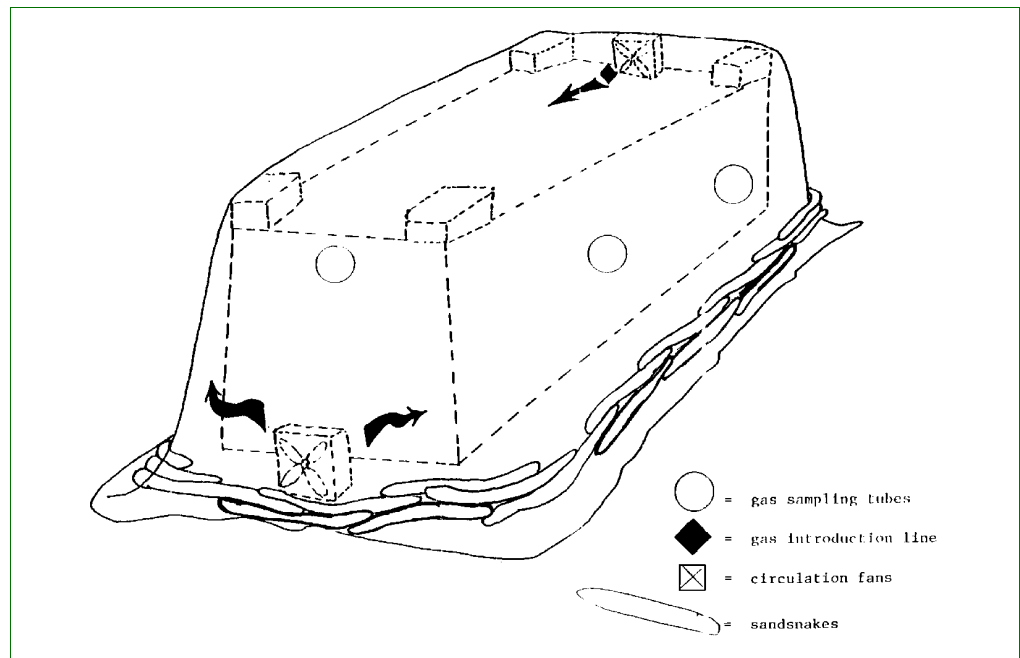

Figure 2-4-4 Typical Break Bulk Arrangement with Fans, Leads, Introduction Line, Padding, and Sand Snakes

Step 10: Measuring the Temperatures

NOTICE

Commodity and space temperatures **must** be 40 °F or above.

Temperature recordings should be rounded to the nearest tenth of a degree (°C or °F).

The PPQ official **must** determine the temperature of the commodity in order to select the proper dosage rate. Depending on whether or **not** you are fumigating a pulpy fruit or vegetable, **either** the commodity temperature **or** an average of the commodity and air temperatures will be used. A pulpy fruit or vegetable can support internal feeding insects, is fleshy and moist, and can be probed with a temperature measuring device. Examples include, but are **not** limited to peppers, onions, and grapes.

For pulpy fruits and pulpy vegetables, insert the thermometer into the pulp and use **only** the commodity temperature to determine the dosage rate. For

commodities that have been refrigerated, probe the fruit that have the lowest pulp temperature. Again, fumigate only when the fruit pulp is 40 °F or higher.

NOTICE

Fresh fruits and vegetables that require fumigation treatment as a condition of entry, must meet the minimum temperature requirement of 40 °F (4.4 °C), at the time of discharge. This may require the gradual warming of the shipment over the later course of the voyage to ensure that the commodity achieves the proper minimum temperature of 40 °F (4.4 °C).

This process will facilitate whether or not the fumigation treatment of the cargo takes place on the same day of arrival.

If the commodity has no pulp (for example, peas, beans, grains, herbs, spices, etc.) take the temperature of the air space immediately surrounding the commodity as well as the commodity temperature and use [Table 2-4-4](#) to determine the correct temperature for use when selecting the proper dosage rate.

To take temperature readings, use a calibrated bimetallic, mercury, or digital long-stem thermometer.

NOTICE

The presence of ice indicates temperatures below 40 °F. If ice is present anywhere in the box, pallet, or fumigation enclosure, do **not** fumigate the commodity.

Table 2-4-4 Determine Whether to Use Commodity or Air Temperature for Determining Dosage Rate for Nonpulpy Commodities

If the air temperature is:	And:	Then, for commodities other than pulpy fruits, pulpy vegetables, or logs and lumber:
Higher than the commodity temperature	→	Use the single lowest commodity temperature for determining the dosage rate (Do not use the average commodity temperature.)
Lower than the commodity temperature	By less than 10 degrees	
	By 10 degrees or more	Use the average of the single lowest air and commodity temperatures for determining the dosage rate. (Never initiate a fumigation if any commodity temperature reads lower than 40 °F.)

EXAMPLE You are about to fumigate a shipment of fresh herbs. The commodity temperature is 82 °F and the air temperature is 55 °F. Average the air and commodity temperatures to determine the dosage rate because the air is 27 degrees lower than the commodity temperature and the commodity is not pulpy. The average of the two temperatures is 68.5 °F. Use 68.5°F to determine the dosage rate. (T101-n-2: use 2.5 lbs. for 2 hours)

Logs and Lumber

The PPQ official will select several representative locations within the stack at the ends of the logs or pieces of lumber. Require the fumigator to drill holes in them to accommodate a thermometer. After drilling, wait at least 10 minutes to allow the wood around the holes to cool. Insert the thermometer into the drilled holes. Record the temperature from each hole.

Base the dosage calculation on the lowest reading obtained. Do **not** average temperatures. All readings **must** be above 40 °F to initiate the fumigation. If **not**, the fumigation **must** be postponed.

The PPQ official **must** record the temperatures in Block 22 of the PPQ Form 429A.

In the electronic 429 database, record the temperatures in the space and commodity fields in the Treatment form.

NOTICE

When the commodity and air temperature drastically differ, moisture may condense inside the gas sampling tubes or inside the gas detection device and cause inaccurate gas concentration readings. The fumigator is responsible for ensuring that the gas sampling tubes are free from water as described in the instrument instruction manual. The PPQ official must check the Drierite and Ascarite frequently, and change it as soon as it becomes saturated with water (turns pink) to obtain true gas concentration readings. **Never** fumigate commodities that are frozen.

Step 11: Covering the Stack

The fumigator must cover the stack, check the tarpaulin for rips, tears, and holes, look at the spots that have been taped, and verify they are properly sealed. If needed, the fumigator must repair all holes, rips, and tears.

The tarpaulin should be made of a material such as vinyl, polyethylene plastic, or coated nylon.

- ◆ 4 mil vinyl or polyethylene plastic tarpaulins are only approved for **one** usage
- ◆ 6 mil vinyl or polyethylene plastic tarpaulins may be used up to **four** times with the PPQ official's approval for each usage

- ◆ 10 to 12 mil vinyl or plastic coated nylon tarpaulins may be approved for multiple uses with the PPQ official's approval for each usage

The fumigator should cover all corners and sharp ends with burlap or other padding to prevent the tarpaulin from ripping. Have the fumigator pull the tarpaulin over the stack, being careful **not** to catch or tear the tarpaulin. Make sure there is sufficient structural support to raise the tarpaulin 2 feet above and 1 foot beyond the sides of the commodity.

The tarpaulin **must** be large enough to provide a floor overlap of at least 18 inches around all sides of the stack. The fumigator must carefully lay the tarpaulin out to prevent excess folds or wrinkles along the floor, especially around corners.

NOTICE

Sealed containers and vans cannot be considered "fumigation chambers" and therefore **must** be covered by a tarpaulin unless they can pass the pressure-leakage test. (Refer to Chapter 2-8.)

Step 12: Sealing the Tarpaulin

The fumigator must seal the tarpaulin with loose, wet sand, sand snakes, water snakes, adhesives, or a combination. If there is danger of crushing or crimping the gas sampling or introduction tubes, use the loose, wet sand. If using snakes, use two rows of snakes along the sides and three rows on the corners. The snakes should overlap each other by approximately 1 foot. The goal in sealing the tarpaulin is to get the tarpaulin to lie flat against the floor to prevent gas from leaking out. When wind is **not** a factor, plastic tape may be used for sealing the tarp. The tape **must** be at least 2 inches in width, and applied (only to a smooth surface) with the aid of high-tack spray adhesive.

The fumigator **must** seal the corners by laying two sand snakes around the corner and working the tarpaulin until it is flat. Place a third snake on top of the two other snakes to provide additional weight to force the tarpaulin against the

floor. Loose, wet sand can be used in the area where the gas introduction line, electrical cords, and gas sampling tubes extend from under the tarpaulin.

Step 13: Measuring the Volume

Using a 100-foot tape measure, the PPQ official and the fumigator **must** carefully measure the length, width, and height of the enclosure. **Never** estimate the measurements. An error in measurement of as little as 12 inches can result in miscalculation of the dosage by as much as 15 percent. When measuring, round off to the nearest quarter foot (example: 3 inches = .25 feet). In the case of fumigations of edible commodities, an error can result in an unacceptable level of residue on the commodity. If the sides of the enclosure slope outward from top to bottom, measure both the top and bottom and average the two to determine the dimension. Enclosure height should always be uniform and **not** require adjustment.

Formula for determining volume:

Length x Width x Height = volume in cubic feet

EXAMPLE A stack with measurements H=10'6", L=42'3", W=10'9"
 $10.50 \times 42.25 \times 10.75 = 4,768.9 \text{ ft}^3$ round to 4,769 ft^3

The PPQ official **must** record the volume in Block 26 of the PPQ Form 429A.

In the electronic 429 database, record the length, width, and height in the corresponding fields under the "AMT of Gas Introduced" heading on the Treatment form. The total volume of the enclosure will be calculated.

Step 14: Calculating the Dosage

The PPQ official $\searrow \triangleright \nabla \triangleleft$ calculate the dosage using the following steps:

1. Refer to the treatment schedule for the correct dosage rate (lbs/1000 ft^3) based on temperature. See [Measuring the Temperatures](#) on page 2-4-21.
2. Multiply the dosage rate (lbs/1000 ft^3) by the volume (ft^3) to get the dosage in pounds.
3. Round to the nearest 1/4 pound.

$$\text{Dosage (lbs.)} = \frac{\text{Volume (ft}^3\text{)} \times \text{Dosage Rate (lbs.)}}{1,000 \text{ ft}^3}$$

Figure 2-4-5 Formula for Calculating MB Dosage for Tarpaulin Fumigations

In the electronic 429 database, the PPQ official **must** enter the dosage rate in the “dosage” field and the total amount of gas required for the fumigation will be displayed in the “GAS REQUIRED” field.

EXAMPLE You need to determine the dosage rate for a stack with a volume of 3,000 ft³. For 72 °F (air and commodity temperatures), the treatment schedule lists the dosage rate at 2 pounds per 1,000 ft³. Determine the dosage using the following calculation:

$$3,000 \text{ ft}^3 \times 2 \text{ lbs./1000 ft}^3 = 6 \text{ lbs. methyl bromide}$$

Step 15: Making a Final Check

Before introducing the gas, the PPQ official and the fumigator **must** ensure that the following activities are performed:

1. Turn on all fans and APHIS-approved gas detection devices to make sure they work.
2. Warm up and zero APHIS-approved gas detection devices (if required) as described in [Equipment](#) on page 8-1-1.
3. Start volatilizer and heat water to 200 °F or above. A minimum temperature of 150 °F is required at all times during the introduction process. Refer to [Volatilizer](#) on page 8-1-14 for temperature monitoring procedures.
4. Place fumigant cylinder with gas introduction line on scale and take the initial weight.
 - A. Ensure the gas introduction hose is attached to the cylinder.
 - B. After obtaining the correct weight, subtract the dosage to be introduced into the enclosure.
 - C. After introducing the proper amount of gas, the scale will be balanced.
5. Ensure that the tarpaulin is placarded and the area secured; only people working on the fumigation are allowed in the area.
6. Ensure that the tarpaulin is free from rips, holes, and tears.
7. Ensure that all gas sampling tubes are labeled and are **not** crimped or crushed.
 - ❖ Visually inspect sampling tubes or use a gas detection device, an electric or Mityvac[®] hand pump to test for unrestricted gas flow.

Erroneous gas readings may occur if the sampling tubes become blocked or crimped. It would be impossible to install new sampling tubes during the fumigation. To avoid an unsuccessful fumigation, test sampling tubes before the treatment begins.

Refer to the following steps to test the sampling tubes using a MityVac pump: (See [Mityvac Hand-Held Vacuum Pump](#) on page 8-1-23)

1. Prior to gas introduction, connect a MityVac hand-held vacuum pump to a sampling tube.
2. Squeeze the handle on the MityVac unit. If the line is blocked, a vacuum will be indicated on the MityVac gauge. For sampling tubes longer than 25 feet, squeeze the handle two or three times. The MityVac pump has the capacity to attain and hold 25 inches of Hg vacuum and a minimum of 7 psig pressure.
3. Disconnect the MityVac pump from the sampling tube and repeat this procedure for each sampling tube.

8. Verify that there is enough gas in the cylinder and if necessary, that other cylinders are available.
9. Check the gas introduction line connections to ensure they are tight and free of leaks (wearing the SCBA.)
10. Verify that all safety equipment, especially SCBA, is available and in working order.
11. If using a T/C analyzer, install Drierite® and Ascarite® filters as required in [Thermal Conductivity Gas Analyzers](#) on page 8-1-2

Other gas detection devices may **not** require the use of Drierite® or Ascarite®.

Conducting the Fumigation

Step 1: Introducing the Gas

CAUTION

The PPQ official **must** wear SCBA anytime the MB concentration level in the air is unknown or greater than or equal to 5 ppm.

MB 2016 Label

NOTICE

If MB concentration levels are between 1-4 ppm, the PPQ official and the fumigator may wear an air purifying respirator NIOSH certified half-mask or full face piece with a cartridge.

Require the fumigator to use SCBA while introducing and adding gas. The PPQ official is **not** required to be in the treatment buffer zone during the fumigation. The PPQ official **must** ensure that the fumigator turns on all fans

before introducing the gas. When using large cylinders of MB, the fumigator should slightly open the cylinder valve, then close the valve.

 **DANGER**

If the PPQ official or fumigator notices a cloud, plume, vapor, or mist coming from the introduction equipment during gas introduction, the fumigator **must** TURN OFF the valve on the gas cylinder, EVACUATE the area immediately, and ABORT the fumigation.

No person should place any part of their body into the cloud, plume, vapor, or mist. After the cloud plume has dissipated, measure gas concentration levels at the gas cylinder using any APHIS-approved continuous real time gas detection device.

When gas concentration levels at the cylinder reach 5 ppm or less, the fumigator **must** identify the source of the leak and correct it before restarting the fumigation.

Any person within the treatment buffer zone **must** wear and use SCBA equipment during gas introduction and gas addition.

With an APHIS-approved continuous real time gas detection device, the fumigator **must** check all connections on the gas introduction hose (between the MB cylinder and the volatilizer) for leaks. If leaks are found the fumigator **must** tighten the connections and repeat the test.

When **no** leaks are found, require the fumigator to open the valve to the point where 3 to 4 pounds of MB are being introduced per minute. The water temperature in the volatilizer should **never** go below 150 °F at any time during gas introduction. The water in the volatilizer may include an antifreeze and should be handled with the appropriate safeguards.

 **CAUTION**

Do **not** touch the gas introduction line with your bare hands—you could get burned! Close the cylinder valve once the proper dosage has been introduced.

The fumigation time begins once all the gas has been introduced. The PPQ official **must** record the time gas introduction was started and completed in Block 32 on the PPQ Form 429A.

In the electronic 429 database, record the fumigation date, gas introduction start and finish time in the corresponding fields under the “GAS INTRODUCTION” heading on the Treatment form.

Require the fumigator to run the fans for 30 minutes to achieve even gas distribution. The PPQ official **must** take the initial concentration reading 30 minutes after all the gas has been introduced.

Do **not** begin counting the fumigation time until all the gas has been introduced and the valve on the MB tank is closed.

Step 2: Testing for Leaks

Require the fumigator to wear the SCBA to test for leaks using an APHIS-approved leak detection device before the 30 minute reading or anytime when the concentration level is unknown or above 5 ppm.

MB 2016 Label

NOTICE

If MB concentration levels are between 1-4 ppm, the PPQ official and the fumigator may wear an air purifying respirator NIOSH certified half-mask or full face piece with a cartridge.

The fumigator **must** test around the perimeter of the tarpaulin on the floor, corners, and especially where electric cords, gas sampling tubes, or gas introduction lines are present. When the fumigator detects leaks, ensure that they are sealed using more sand or sand snakes for floor leaks and tape for sealing small holes in the tarpaulin. Loose, wet sand may be used to reduce leakage from electric cords, gas sampling tubes, gas introduction lines, or uneven flooring.

NOTICE

If a PPQ employee encounters unsafe conditions (such as holes in the tarpaulin or a breach in safety protocol) and the condition(s) **cannot** be corrected in a timely manner, the employee may CANCEL the fumigation. Consult with a PPQ Supervisor prior to cancellation.

If the fumigator detects excessive leakage (concentration readings of 50 percent or less of the minimum concentration), do **not** attempt to correct the problem by adding more gas. For non-food, non-feed commodities, require the fumigator to quickly evacuate the remaining gas from the enclosure, eliminate the problem, and construct a new enclosure. Aerate as usual following procedures outlined in [Aeration](#) on page 2-4-38. If the commodity is non-food or feed, restart the fumigation in the new enclosure.

 **CAUTION**

Commodities used for food or feed **cannot** be re-treated. The commodity must be either:

- ◆ Returned to the country of origin
- ◆ Re-exported to another country (if they will accept the shipment)
- ◆ Destroyed by incineration

Step 3: Taking Concentration Readings

Before taking concentration readings, require the fumigator to purge the gas sampling tubes with a mechanical or hand pump. If using a T/C analyzer, connect it to the gas sampling tube, adjust the gas flow rate to 1.0, and wait until the meter registering “ounces per thousand cubic feet” stabilizes. This may take a minute or more, depending on the length of the gas sampling tube and whether or **not** an auxiliary pump is used.

The PPQ official **must** take concentration readings 30 minutes after gas introduction. Use an APHIS-approved gas detection device to determine the gas concentration and distribution within the enclosure. Allow gas concentration readings to stabilize; do **not** disconnect the sampling line from the gas detection device when the minimum concentration reading has been met. If the gas distribution is even (all readings within 4 ounces of each other) and meet the minimum concentration required by the treatment schedule, advise the fumigator to turn off the fans. Running the fans longer can contribute to gas leakage. If used, the PPQ official **must** check desiccant tubes before each reading and change Drierite® if its color is pink.

NOTICE

Living plant and plant products generate carbon dioxide gas, which interferes with the MB readings from the T/C. In order to remove CO₂, install an Ascarite® tube in line with the Drierite® tube if fumigating living plant and plant products, including fruits and vegetables, timber, flowers, and seeds.

Take concentration readings at the times designated in the treatment schedule:⁶

- ◆ 30 minutes
- ◆ 2 hours
- ◆ 4 hours
- ◆ 6 hours
- ◆ 12 hours
- ◆ 24 hours

⁶ If fumigating oak logs or lumber for export, see “Special Procedures for Adding Gas to Oak logs and Lumber.”

- ◆ 36 hours
- ◆ 48 hours
- ◆ 72 hours
- ◆ Any final concentration reading

Avoid using hand-held two-way radios near the T/C analyzer. Two-way radios may interfere with an accurate concentration reading.

Thirty-minute Reading

The 30-minute reading shows the initial concentration and distribution of gas. The 30-minute reading can indicate leakage, sorption, incorrect dosage calculation, or error in fumigant introduction—all of which require immediate attention. If the 30-minute readings are below the minimum, require the fumigator to check for leaks around the perimeter of the tarpaulin.

Concentration readings should **not** differ more than 4 ounces among the leads. When concentration readings differ more than 4 ounces, run the fans to equalize the gas and record readings in the Remarks block on the PPQ Form 429A. In some cases, several cycles of fan operation may be necessary to equalize the readings. The PPQ official will record all gas readings on the PPQ Form 429A or in the electronic 429 database.

Two-hour Reading

In comparison with the 30-minute reading, the 2-hour reading also will indicate if the tarpaulin is leaking or the commodity is absorbing gas. Refer to Table 2-4-8 on page 2-4-37 for detailed instructions.

EXAMPLE The dosage for the fumigation was 4 pounds (64 ounces). The 30-minute reading was 50 ounces. The 2-hour reading is 26 ounces. The 2-hour reading is low and according to [Table 2-4-8](#) the fumigation needs to be extended by 30 minutes.

Final Reading

The final reading is required for all tarpaulin fumigations in order to determine if the fumigation has been successfully completed. You (the PPQ official) may start the final reading before the finishing time of the treatment so that aeration commences at the finishing time. Starting the final reading before finishing time is especially critical when fumigating perishables.

Additional Readings

Decide the need to take additional readings based on the following:

- ◆ Any condition which could change the gas concentration, such as severe winds, or rain

◆ Rate of gas concentration decrease

When concentration readings differ by more than **4 ounces**, run the fans to equalize the gas and record readings in the Remarks block on the APHIS 429A. Generally, gas should be evenly distributed, and you should **not** have to restart the fans unless you added gas. If readings continue to differ by more than 4 ounces, continue running the fans until the gas is evenly distributed.

If unpredicted severe winds occur, additional readings **must** be taken. Any sharp or unusual decreases of the readings in relation to previous readings is a clue to take corrective action and supplementary readings. Take additional readings every 30 minutes until problems are rectified.

Sorptive commodities may also require additional concentration readings. See [Sorption](#) on page 2-3-10.

Step 4: Determining the Need to Add Gas and Adjust Exposure

Use [Table 2-4-5](#) to determine when to add gas or extend exposure period.

Table 2-4-5 Determine the Need to Add Gas and Adjust Exposure

If the lowest gas reading is:	And the treatment schedule is:	Then:
Below the required minimum concentration	T101-a-1 or equivalent ¹	See Table 2-4-7 on page 2-4-36 for corrections at 0.5 hour, or Table 2-4-8 on page 2-4-37 for corrections at 2 hours.
	Other than T101-a-1 or equivalent ¹	See Adding Gas and Extending Exposure Period to Commodities that are Fumigated Using Treatment Schedules Other Than T101-a-1 or Equivalent (may include perishables) on page 2-4-33
At or above the required minimum concentration	T101-a-1 or equivalent ¹	See Table 2-4-7 on page 2-4-36 for actions to take at 0.5 hours, or Table 2-4-8 on page 2-4-37 for actions to take at 2 hours.
	Other than T101-a-1 or equivalent ¹	No action necessary.

1 T101-a-1 or equivalent schedules are those schedules that are:

- ◆ NOT greater than 2 hours long (exposure time)
- ◆ NOT greater than 4 lbs. per 1000 ft³ (dosage rate)
- ◆ Minimum concentration readings and temperature ranges match EXACTLY the readings in T101-a-1

If the minimum concentration readings do not meet these requirements, the schedule is **NOT** equivalent. When schedules are **NOT** equivalent, use [Table 2-4-5](#) to determine the length of time to extend exposure and use the formula in to determine the amount of gas to add.

Special Procedures for Adding Gas and Extending Exposure Period⁷

Adding Gas and Extending Exposure Period to Commodities that are Fumigated Using Treatment Schedules **Other Than T101-a-1 or Equivalent** (may include perishables)

Use Table 2-4-6 to determine if you need to add gas or extend or decrease the exposure time to T101-a-1 schedules that are **not** equivalent. Use the formula in Figure 2-4-6 to determine the amount of gas to add.

$$1.6 \times \text{number of ounces below minimum} \times \frac{\text{volume in cubic feet}}{1000 \text{ cubic feet}} \times \frac{1}{16} = \text{pounds of gas to add}$$

Figure 2-4-6 Formula for Determining the Amount of Gas to Add to Schedules Not Equivalent to T101-a-1

Table 2-4-6 Determine the Extended Exposure Period for Non-equivalent Schedules

If the exposure time is:	And any individual reading is below minimum by: ¹	Then extend exposure:
Less than 12 hours	10 oz. or less	10 percent of the time lapse since gas introduction or the last acceptable reading
	11 oz. or more	30 minutes
12 hours or more	10 oz. or less	10 percent of the time lapse since gas introduction or the last acceptable reading
	11 oz. or more	2 hours or 10 percent of the time lapse since the last acceptable reading, whichever is greater

- 1 If any individual reading is 50 percent or more below the minimum concentration reading, then abort the treatment. For example, if the minimum reading is 38 ounces then the reading 50 percent below the minimum is 19 ounces (38 oz. - (30 oz. x 0.50) = 19 oz.) For oak logs (T312-a, T312-a-alternative), refer to Special Procedures for Adding Gas to Oak Logs Using T312-a or T312-a-Alternative for specific instructions.

When adding gas, require the fumigator to follow these steps:

1. Heat water in volatilizer.
2. Turn on fans.
3. Weigh cylinder.

⁷ The MB label does allow the extension of exposure time due to low gas readings for non-food commodities.

4. With SCBA on, open valve on cylinder and introduce gas.
5. Close valve when the weight of the cylinder indicates that the needed amount of gas has been added.
6. The PPQ official must record quantity of fumigant added in Block 34 and additional fan time in Block 30 of the PPQ Form 429A.
7. In the electronic 429, record the amount of gas added in the “Additional Gas Recommended” field and the actual amount of additional gas added in the “ACTUAL ADDITIONAL GAS” field. Record the additional fan time in the “TIME FANS OPERATED” field in the Treatment form.
8. Note the time the fumigator started introducing additional gas and the time the fumigator finished introducing gas and record in Block 40 (Remarks) of the PPQ Form 429A or in the “Remarks” form in the electronic 429 database. Require the fumigator to run the fans for 30 minutes. Turn off fans, then take a concentration reading. If all readings are above minimum concentration levels, then proceed as usual with the remaining scheduled concentration readings.

Adding Gas to Fruits, Vegetables, or Perishable Commodities Using Schedule T101-a-1 or Equivalent

Use [Table 2-4-7](#) and [Table 2-4-8](#) to determine if you need to add gas or extend or decrease the exposure time. Select the proper table based on the time of the gas reading (30 minutes or 2 hours).

Use the formula in [Figure 2-4-7](#) to determine the amount of gas to add.

$$1.6 \times \text{number of ounces below minimum} \times \frac{\text{volume in cubic feet}}{1000 \text{ cubic feet}} \times \frac{1}{16} = \text{pounds of gas to add}$$

Figure 2-4-7 Formula for Determining the Amount of Gas to Add to Schedules Equivalent to T101-a-1

NOTICE

DO **NOT** average the gas concentration readings before using the tables. Base your decision on whether to add gas from the **LOWEST** gas concentration reading of any individual gas reading.

CAUTION

Fresh fruits and vegetables are sensitive to MB, so double check volume calculations and dosage measurements to avoid accidental overdoses.

When adding gas, require the fumigator to follow these steps:

1. Heat water in volatilizer.
2. Turn on fans.
3. Weigh cylinder.
4. With SCBA on, open valve on cylinder and introduce gas.
5. Close valve when the weight of the cylinder indicates that the needed amount of gas has been added.
6. The PPQ official must record quantity of fumigant added in Block 34 and additional fan time in Block 30 of the PPQ Form 429A.
7. In the electronic 429, record the amount of gas added in the “Additional Gas Recommended” field and the actual amount of additional gas added in the “ACTUAL ADDITIONAL GAS” field. Record the additional fan time in the “TIME FANS OPERATED” field in the Treatment form.
8. Note the time the fumigator started introducing additional gas and the time the fumigator finished introducing gas and record in Block 40 (Remarks) of the PPQ Form 429A or in the “Remarks” form in the electronic 429 database. Run the fans until there is even gas distribution throughout the stack. Turn off fans, then take a concentration reading 30 minutes after the gas has been introduced. If all readings are above minimum concentration levels, then proceed as usual with the remaining scheduled concentration readings.

Table 2-4-7 Determine Gas Concentration Values and Corrections for Fruits and Vegetables at the 30-minute Reading of T101-a-1 or Equivalent Schedules

If the schedule is:	And the minimum concentration reading (oz.) in the schedule is:	And the lowest concentration (oz.) is:	Then:
40-49 °F 4 lbs. for 2 hrs.	48	65 or greater	REDUCE exposure by 15 minutes
		64-48	TAKE 2 hour reading as scheduled
		Lower than 48	1. ADD gas, and 2. EXTEND exposure by 15 minutes
50-59 °F 3 lbs. for 2 hrs.	38	52 or greater	REDUCE exposure by 15 minutes
		51-38	TAKE 2 hour reading as scheduled
		Lower than 38	1. ADD gas, and 2. EXTEND exposure by 15 minutes
60-69 °F 2.5 lbs. for 2 hrs.	32	48 or greater	REDUCE exposure by 15 minutes
		47-32	TAKE 2 hour reading as scheduled
		Lower than 32	1. ADD gas, and 2. EXTEND exposure by 15 minutes
70-79 °F 2 lbs. for 2 hrs.	26	37 or greater	REDUCE exposure by 15 minutes
		36-26	TAKE 2 hour reading as scheduled
		Lower than 26	1. ADD gas, and 2. EXTEND exposure by 15 minutes
80-89 °F 1.5 lbs. for 2 hrs.	19	27 or greater	REDUCE exposure by 15 minutes
		26-19	TAKE 2 hour reading as scheduled
		Lower than 19	1. ADD gas, and 2. EXTEND exposure by 15 minutes

Table 2-4-8 Determine Gas Concentration Values and Corrections for Fruits and Vegetables at the 2-Hour Reading of T101-a-1 or Equivalent Schedules

If the schedule is:	And the lowest concentration (oz.) at 2 hours is:	Then do not add gas, but::
40-49 °F 4 lbs. for 2 hrs.	38 and above	AERATE commodity
	37-28	EXTEND exposure by 15 minutes
	27-25	EXTEND exposure by 30 minutes
	Lower than 25	ABORT
50-59 °F 3 lbs. for 2 hrs.	29 and above	AERATE commodity
	28-24	EXTEND exposure by 15 minutes
	23-21	EXTEND exposure by 30 minutes
	Lower than 21	ABORT
60-69 °F 2.5 lbs. for 2 hrs.	24 and above	AERATE commodity
	23-21	EXTEND exposure by 15 minutes
	20-18	EXTEND exposure by 30 minutes
	Lower than 18	ABORT
70-79 °F 2 lbs. for 2 hrs.	19 and above	AERATE commodity
	18-16	EXTEND exposure by 15 minutes
	15-13	EXTEND exposure by 30 minutes
	Lower than 13	ABORT
80-89 °F 1.5 lbs. for 2 hrs.	14 and above	AERATE commodity
	13-12	EXTEND exposure by 15 minutes
	11-10	EXTEND exposure by 30 minutes
	Lower than 10	ABORT

Special Procedures for Adding Gas to Oak Logs Using T312-a or T312-a-Alternative

There are two alternative treatments for the MB fumigation of oak logs. Refer to Table 5-4-3 on page 5-4-38 and Table 5-4-4 on page 5-4-41 for actions to take during the fumigation of oak logs using T312-a or T312-a-Alternative.

Step 5: Exhausting the Gas

Require the fumigator to exhaust the gas at the completion of the exposure period. If the treatment schedule is a FIFRA Section 18 Exemption, then the PPQ official **must** verify the final gas concentration reading. Record detector tube readings and the time interval from the aeration in the corresponding fields in “DETECTOR READINGS”.

Aeration

The fumigator must:

- ◆ Arrange for the aeration to proceed once the treatment is completed.
- ◆ Consider the wind direction when pointing the exhaust duct, and face the duct outlet toward an open area away from people.
- ◆ Ensure that, during the first 10 minutes of aeration, no one is present within 200 feet downwind of the exhaust duct outlet.
- ◆ Determine aeration buffer zones in accordance with [Environmental Protection Agency \(EPA\) Methyl Bromide Commodity Fumigation Buffer Zone Lookup Tables](#).
- ◆ Ensure no one is present within the perimeter of the aeration buffer zone unless they are wearing SCBA.
- ◆ Refer to “Buffer Zone Overlap for Multiple Enclosures”.
- ◆ Follow all label instructions, state, county, and local regulations, in addition to the instructions in this manual.
- ◆ Inform people located in occupied structures and personnel in the immediate area within the buffer zone that release of MB is about to take place and give them the option of leaving the area or remaining inside the building.
- ◆ Restrict access to the area where the exhaust duct extends beyond the enclosure.

Responsibility for Aerating the Commodity

The label requires that at least two people trained in the use of the fumigant **must** be present at all times during gas introduction, treatment, and aeration. The PPQ official, however, is **not** required to be present at the fumigation site throughout the aeration process unless specified by the label or by State or local regulations. Refer to [Table 2-4-9](#) to determine responsibility for aerating the commodity.

Table 2-4-9 Determine Responsibility for Aerating the Commodity

If the treatment schedule is:	Then:
A FIFRA Section 18 Exemption	<ol style="list-style-type: none"> 1. PPQ official must be present at the initiation of aeration and to VERIFY the final aeration readings. 2. USE Table 2-4-10 to determine which aeration procedure to follow.
A labeled Treatment Schedule	<ol style="list-style-type: none"> 1. RELEASE the fumigation to the fumigator to aerate according to Table 2-4-10. 2. RELEASE the commodity.

Refer to [Table 2-4-10](#) to determine which aeration procedure to use.

Table 2-4-10 Determine the Aeration Procedure

If:	And:	And:	Then:
Nonsorptive	Containerized	→	GO to page 2-4-40
	Noncontainerized	Fresh fruits and vegetables, and cut flowers	GO to page 2-4-43
		Other than fresh fruits and vegetables, and cut flowers	GO to page 2-4-41
Sorptive, including yams and chestnuts (see Sorption on page 2-3-10 for a list of sorptive commodities)	Containerized	→	GO to page 2-4-47
	Noncontainerized	→	GO to page 2-4-45

Aeration Buffer Zones

The aeration buffer zones are determined by the fumigator in accordance with [Environmental Protection Agency \(EPA\) Methyl Bromide Commodity Fumigation Buffer Zone Lookup Tables](#).

Wearing Respiratory Protection

The fumigator **must** wear approved respiratory protection (SCBA, supplied air respirator, or a combination unit) when:

- ◆ A risk of exposure to concentrations above 5 ppm exists; this includes any time the concentration is unknown
- ◆ Opening the tarpaulin for aeration
- ◆ Removing the tarpaulin if measured levels of fumigant are above 5 ppm

- ◆ Setting up the air introduction and exhaust systems (if they were not set up prior to gas introduction)

MB 2016 Label

NOTICE

If MB concentration levels are between 1-4 ppm, the PPQ official and the fumigator may wear an air purifying respirator NIOSH certified half-mask or full face piece with a cartridge.

Aerating Nonsorptive, Containerized Cargo—Indoors and Outdoors

Step 1: Installing Exhaust System

Advise the fumigator to:

1. Install an exhaust fan (minimum of 5,200 cfm capacity) to a 16 inch, or greater, diameter duct located at the floor near rear doors of the container.
2. Install an air introduction duct system consisting of a 3,750 cfm, or greater, fan attached to a 12 inch, or larger, duct which reaches two-thirds of the length of the container at the top of the load. Have the ducts installed prior to the start of fumigation. For indoor fumigation, extend the exhaust duct at least 30 feet beyond the building or through a vertical stack extending through the roof. For outdoor fumigations, extend the exhaust duct at least 30 feet beyond the container.

NOTICE

The exhaust fan(s) must be capable of a minimum of 10 air exchanges per hour. The sum of cubic feet per minute (cfm) of the exhaust fan(s) or exhaust blower divided by the volume of the enclosure (in cubic feet) and multiplying the fraction by 60 equals the number of complete gas volume exchanges per hour.

Refer to [Figure 2-4-8](#) and the associated example for the formula for calculating the air exchange rate (AER).

$$AER = \frac{\text{Sum CFM of all exhaust fans} \left(\frac{\text{cubic feet}}{\text{min}} \right)}{\text{Volume enclosure (cubic feet)}} 60 = \frac{\text{Air Exchanges}}{h}$$

Figure 2-4-8 Formula to Calculate Air Exchange Rate (AER)

EXAMPLE

$$AER = \frac{(6,000 + 9,000) \left(\frac{\text{cubic feet}}{\text{min}} \right)}{50,000 \text{ (cubic feet)}} 60 = \frac{18 \text{ Air Exchanges}}{h}$$

Step 2: Aerating the Commodity

Advise the fumigator to:

1. Connect the exhaust duct to the exhaust fan.
2. Start the exhaust fan(s) and lift the end of the tarpaulin opposite the end at which the exhaust fan and duct are located.
3. Aerate for 3 hours.
4. Stop the aeration fans.
5. Use a colorimetric tube to take a concentration reading in the airspace around and, when feasible, within the carton or box. Exceptions may include compressed cotton and other very difficult to probe commodities. Obtain prior approval from S&T-TMT for exceptions to this rule.

For FIFRA Section 18 Exemptions, record the concentration reading (in ppm), date, and time in Block 39 of PPQ Form 429A. In the electronic 429 database, record the date, time, and detector reading (in ppm) in “Detector Readings” field.

Then use [Table 2-4-11](#) to determine when to release the commodity.

Table 2-4-11 Determine When to Release the Commodity for Nonsorptive, Containerized Cargo

If the gas concentration level is:	Then:
5 ppm or less	RELEASE the commodity
6 ppm or more	1. CONTINUE aeration until the concentration is 5 ppm or less, then 2. RELEASE the commodity

Aerating Nonsorptive, Noncontainerized Cargo—Indoors and Outdoors

Step 1:

Advise the fumigator to:

1. Install an exhaust duct (minimally one 3,500 cfm capacity fan connected to an exhaust duct). An exhaust duct is optional for outdoor fumigations.
2. Extend the exhaust duct outlet to an outside area where there is adequate ventilation and at least 30 feet away from the building or through a vertical exhaust stack extending through the roof.

NOTICE

The exhaust fan(s) **must** be capable of a minimum of four air exchanges per hour. The sum of cubic feet per minute (cfm) of the exhaust fan(s) or exhaust blower divided by the volume of the enclosure (in cubic feet) and multiplying the fraction by 60 equals the complete gas volume exchanges per hour. Refer to [Figure 2-4-8](#) and the associated example for the formula for calculating the air exchange rate (AER).

Step 2: Aerating the Commodity

Advise the fumigator to:

1. Start the exhaust fan.
2. Lift the end of the tarpaulin opposite the end with the exhaust fan and duct (if used).
3. Aerate the enclosure for 2 hours.

Outdoor Fumigations

Advise the fumigator to:

1. Stop the fans.
2. Remove the tarpaulin.
3. Take concentration readings with colorimetric tubes in the airspace around and, when feasible, inside the box or cartons.

For FIFRA Section 18 Exemptions, record the concentration reading (in ppm), date, and time in Block 39 of PPQ Form 429A. In the electronic 429 database, record the date, time, and detector reading (in ppm) in the “Detector Readings” field.

Then use [Table 2-4-12](#) to determine when to release the commodity.

Table 2-4-12 Determine When to Release the Commodity for Nonsorptive, Noncontainerized Cargo—Outdoors

If the gas concentration level is:	Then:
5 ppm or less	RELEASE the commodity
6 ppm or more	1. CONTINUE aeration and take concentration readings until the level is 5 ppm or less, then 2. RELEASE the commodity

Indoor Fumigations

Advise the fumigator to:

1. Stop the fans.

2. Take concentration readings with colorimetric tubes in the airspace around and, when feasible, in the carton or box.

For FIFRA Section 18 Exemptions, record the concentration reading (in ppm), date, and time in Block 39 of PPQ Form 429A. In the electronic 429 database, record the date, time, and detector reading (in ppm) in the “Detector Readings” field.

Then use [Table 2-4-13](#) to determine when to release the commodity.

Table 2-4-13 Determine When to Release the Commodity for Nonsorptive, Noncontainerized Cargo—Indoors

If the gas concentration level is:	Then:
5 ppm or less	<ol style="list-style-type: none"> 1. ADVISE fumigator to REMOVE the tarpaulin, and 2. RELEASE the commodity
6 ppm to 99 ppm	<ol style="list-style-type: none"> 1. ADVISE fumigator to REMOVE the tarpaulin, and 2. CONTINUE aeration until the concentration is 5 ppm or less, then 3. RELEASE the commodity
100 ppm or above	<ol style="list-style-type: none"> 1. CONTINUE aeration and take concentration readings until the concentration level is below 100 ppm, then remove the tarpaulin, and 2. CONTINUE aeration until concentration is 5 ppm or less, then 3. RELEASE the commodity

Aeration Procedures for Fresh Fruits, Vegetables, and Cut Flowers—Indoors or Outdoors

NOTICE

Do **not** use these procedures for fresh chestnuts or yams. (See procedures for sorptive commodities on [page 2-4-45](#).)

Step 1: Installing Exhaust System

Use [Table 2-4-14](#) to determine fan size.

Table 2-4-14 Determine Number of Fans for Aeration of Fresh Fruits, Vegetables, and Cut Flowers

If the enclosure is:	Then:
Up to 1,000 cu ft	USE one fan, 67-350 cfm
1,001 - 15,000 cu ft	USE one or two fans. The sum of the cfm of the fans divided by the volume of the enclosure and multiplying the fraction by 60 should equal four air exchanges per hour or more. Refer to Figure 2-4-8 and the associated example. Connect the fan(s) to exhaust duct(s) 3 feet in diameter.
15,001 - 25,000 cu ft	USE two fans, each 1,000 to 5,000 cfm. The sum of the cfm of the fans divided by the volume of the enclosure and multiplying the fraction by 60 should equal four air exchanges per hour or more. Connect fan(s) to exhaust duct(s) 3 feet in diameter.
More than 25,000 cu ft	CONTACT S&T-TMT for advice prior to conducting the first fumigation.

An alternate procedure to using exhaust fans and ducts is to aerate through a vertical stack.

NOTICE

The exhaust fan(s) must be capable of a minimum of four air exchanges per hour. The sum of cubic feet per minute (cfm) of the exhaust fan(s) or exhaust blower divided by the volume of enclosure (in cubic feet) and multiplying the fraction by 60 equals the number of complete gas volume exchanges per hour. Refer to [Figure 2-4-8](#) and associated example for the formula for calculating air exchange rate (AER).

Step 2: Aerating the Commodity

Advise the fumigator to:

1. Connect the exhaust duct to the exhaust fan.
2. Start the exhaust fan(s) and lift the end of the tarpaulin opposite the end at which the exhaust fan and duct are located.
3. Aerate for 2 hours.
4. Remove the tarpaulin and allow 2 hours for passive aeration.
5. Stop the fans and take concentration readings with colorimetric tubes in the airspace around and, when feasible, inside the cartons or boxes.

For FIFRA Section 18 Exemptions, record the concentration reading (in ppm), date, and time in Block 39 of PPQ Form 429A. In the electronic 429 database, record the date, time, and detector reading (in ppm) in the “Detector Readings” field.

Then use [Table 2-4-15](#) to determine when to release the commodity.

Table 2-4-15 Determine When to Release the Commodity After Aeration of Fresh Fruits, Vegetables, and Cut Flowers—Indoors or Outdoors

If the gas concentration level is:	Then:
5 ppm or less	RELEASE the commodity
6 ppm or more	1. CONTINUE aeration and take concentration readings until the level is 5 ppm or less, then 2. RELEASE the commodity

Aerating Sorptive, Noncontainerized Cargo—Indoors and Outdoors

Step 1: Installing the Exhaust System

Advise the fumigator to:

1. Install an exhaust duct (minimally one 3,500 cfm capacity fan connected to an exhaust duct.)
2. Extend the exhaust duct outlet to an outside area where there is adequate ventilation and at least 30 feet away from the building or through a vertical exhaust stack extending through the roof.

Step 2: Aerating the Commodity

Outdoor Fumigations

Advise the fumigator to:

1. Lift both ends of the tarpaulin.
2. Start the circulation fans and exhaust fans (if available).
3. Aerate oak logs and lumber a minimum of 48 hours. If, after 48 hours, the concentration is 5 ppm or greater, continue aeration for 24 more hours. Continue this procedure until concentration readings are less than 5 ppm.
4. Run the fans for 4 hours for commodities other than oak logs and lumber.
5. Remove the tarpaulin.
6. Stop the fans and take concentration readings with colorimetric tubes in the airspace around and, when feasible, inside the cartons or boxes.

For FIFRA Section 18 Exemptions, record the concentration reading (in ppm), date, and time in Block 39 of PPQ Form 429A. In the electronic 429 database, record the date, time, and detector reading (in ppm) in the “Detector Readings” field.

Then use [Table 2-4-16](#) to determine when to release the commodity.

Table 2-4-16 Determine when to Release the Commodity for Sorptive, Noncontainerized Cargo—Outdoors

If the gas concentration level is:	Then:
5 ppm or less	RELEASE the commodity
6 ppm or more	1. CONTINUE aeration and take concentration readings until the level is 5 ppm or less, then 2. RELEASE the commodity

Indoor Fumigations

Advise the fumigator to:

1. Complete the installation of the exhaust duct.
2. Start the circulation fans and exhaust fans.
3. Lift the end of the tarpaulin opposite the exhaust fan.
4. Aerate oak logs and lumber a minimum of **48 hours**. If, after 48 hours, the concentration is 5 ppm or greater, continue aeration for 24 more hours. Continue this procedure until concentration readings are less than 5 ppm.
5. Run the fans for **4 hours** for commodities other than oak logs and lumber.
6. Stop the fans and take concentration readings with colorimetric tubes in the airspace around and, when feasible, inside the carton or box.
7. Remove the tarpaulin.

For FIFRA Section 18 Exemptions, record the concentration reading (in ppm), date, and time in Block 39 of PPQ Form 429A. In the electronic 429 database, record the date, time, and detector reading (in ppm) in the “Detector Readings” form.

Then use [Table 2-4-17](#) to determine when to release the commodity.

Table 2-4-17 Determine When to Release the Commodity for Sorptive, Noncontainerized Cargo—Indoors

If the gas concentration level is:	Then:
5 ppm or less	1. ADVISE fumigator to REMOVE the tarpaulin, and 2. RELEASE the commodity
6 ppm to 99 ppm	1. ADVISE fumigator to REMOVE the tarpaulin, and 2. CONTINUE aeration until the concentration is 5 ppm or less, then 3. RELEASE the commodity
100 ppm or above	1. CONTINUE aeration and take concentration readings until the concentration level is below 100 ppm, then remove the tarpaulin, and 2. CONTINUE aeration until concentration is 5 ppm or less, then 3. RELEASE the commodity

Aerating Sorptive Commodities in Containers—Indoors and Outdoors

Step 1: Installing the Exhaust System

Advise the fumigator to:

1. Install an exhaust fan (minimum of 5,200 cfm capacity) to a 16 inch or greater diameter duct located at the floor near rear doors of the container.
2. Install an air introduction duct system consisting of a 3,750 cfm or greater fan attached to a 12 inch or greater duct which reaches two-thirds of the length of the container at the top of the load. Have the ducts installed prior to the start of the fumigation. For indoor fumigations, extend the exhaust duct at least 30 feet beyond the building or through a vertical stack extending through the roof. For outdoor fumigations, extend the exhaust duct 30 feet beyond the container.

Step 2: Aerating the Commodity

Indoors

Advise the fumigator to:

1. Complete installation of exhaust duct and begin exhaust fan operation.
2. Lift both ends of the tarpaulin and begin exhaust fan operation. Do **not** remove the tarpaulin until the gas concentration level is below 100 ppm (see [Table 2-4-18](#)).
3. Start the circulation and air introduction fans. Require a minimum of **4 hours** aeration for all sorptive commodities. Sorptive commodities generally require 12 hours or longer to aerate; however, since sorptive commodities vary in their rates of desorption, aeration may be completed in less than 12 hours.
4. Aerate oak logs and lumber a minimum of 48 hours. If, after 48 hours, the concentration is 5 ppm or greater, continue aeration for 24 more hours. Continue this procedure until concentration readings are less than 5 ppm.
5. Stop the fans and take concentration readings with colorimetric tubes in the airspace around and, when feasible, inside the carton or box.

For FIFRA Section 18 Exemptions, record the concentration reading (in ppm), date, and time in Block 39 of PPQ Form 429A. In the electronic 429 database, record the date, time, and detector reading (in ppm) in the “Detector Readings” form.

Then use [Table 2-4-18](#) to determine when to release the commodity.

Table 2-4-18 Determine When to Release the Commodity for Sorptive Commodities in Containers—Indoors

If the gas concentration level is:	Then:
5 ppm or less	1. ADVISE fumigator to REMOVE the tarpaulin, and 2. RELEASE the commodity
6 ppm to 99 ppm	1. ADVISE fumigator to REMOVE the tarpaulin, and 2. CONTINUE aeration until the concentration is 5 ppm or less, then 3. RELEASE the commodity
100 ppm or above	1. CONTINUE aeration and take concentration readings until the concentration level is below 100 ppm, then remove the tarpaulin, and 2. CONTINUE aeration until concentration is 5 ppm or less, then 3. RELEASE the commodity

Outdoors

Advise the fumigator to:

1. Complete installation of exhaust duct and begin exhaust fan.
2. Lift both ends of the tarpaulin that are furthest from exhaust fan.
3. Start the circulation and air introduction fans. Require a minimum of **4 hours** aeration for all sorptive commodities. Sorptive commodities generally require 12 hours or longer to aerate; however, since sorptive commodities vary in their rates of desorption, aeration may be completed in less than 12 hours.
4. Aerate oak logs and lumber a minimum of 48 hours. If, after 48 hours, the concentration is 5 ppm or greater, continue aeration for 24 more hours. Continue this procedure until concentration readings are less than 5 ppm.
5. Remove the tarpaulin after 4 hours aeration.
6. Stop the circulation fans and take concentration readings with colorimetric tubes in the airspace around and, when feasible, inside the cartons or boxes.

For FIFRA Section 18 Exemptions, record the concentration reading (in ppm), date, and time in Block 39 of PPQ Form 429A. In the electronic 429 database, record the date, time, and detector reading (in ppm) in the “Detector Readings” form.

Then use [Table 2-4-19](#) to determine when to release the commodity.

Table 2-4-19 Determine when to Release the Commodity for Sorptive Commodities in Containers—Outdoors

If the gas concentration level is:	Then:
5 ppm or less	RELEASE the commodity
6 ppm or more	1. CONTINUE aeration and take concentration readings until the level is 5 ppm or less, then 2. RELEASE the commodity

Chemical Treatments

Fumigants—Methyl Bromide—Chamber Fumigation

Contents

Methods and Procedures	2-5-1
2016 Methyl Bromide Label Information	2-5-1
Materials Needed	2-5-3
Conducting the Fumigation	2-5-6
Aeration	2-5-10
Normal Atmospheric Pressure Chamber—Aerating Noncontainerized Cargo	2-5-12
Vacuum Fumigation Chambers—Aerating Containerized and Noncontainerized Cargo	2-5-13

Methods and Procedures

The procedures covered in this section provide commercial fumigators and chamber owners with the methods, responsibilities, and precautions for normal atmospheric pressure (NAP) and vacuum chamber fumigations. The chamber owner is responsible for hiring a state certified fumigator and for ensuring that the chamber is certified for conducting PPQ quarantine treatments.

2016 Methyl Bromide Label Information

In 2015, the Environmental Protection Agency (EPA) directed all methyl bromide (MB) registrants to amend the use directions on the labels of all 100% MB products. EPA required the changes in order to reflect recommendations in an EPA report.¹

These amendments modify the use directions for fumigation and aeration procedures, modify respiratory requirements and equipment and update gas monitoring equipment. EPA requires all labels on newly manufactured MB to reflect these recommendations effective **October 01, 2016**; however, EPA is allowing existing stocks of MB to be used in accordance with the use directions on the existing stock's (older) labels.

¹ [“Report of Food Quality Protection Act \(FQPA\) Tolerance Reassessment and Risk Management Decision \(TRED\) for methyl bromide, and Reregistration Eligibility Decision \(RED\) for Methyl Bromide’s Commodity Uses”](#), archive dated August 2006.

PPQ officials and fumigators **must** closely examine gas cylinder labels in order to validate that the dosage, exposure, and commodity are either on the cylinder label or covered by a FIFRA Section 18 exemption. If a label is **not** affixed to the cylinder, **DO NOT** allow the fumigator to use that cylinder.

New Buffer Zone Requirements

All 2016 MB labels now require both a treatment and an aeration buffer zone. Both the treatment and aeration buffer zones are specific to the enclosure being fumigated and must be determined by the [Environmental Protection Agency \(EPA\) Methyl Bromide Commodity Fumigation Buffer Zone Lookup Tables](#). The fumigators are responsible for using this website to determine the buffer zones and reporting both buffer zones to the PPQ official. If the treatment buffer zone is determined to be less than 30 feet, the PPQ official will maintain PPQ's standard 30 foot treatment buffer zone; otherwise, the new treatment buffer zone **must** be observed. If the aeration buffer zone is determined to be less than 200 feet, then PPQ's standard "200 feet for 10 minutes" aeration buffer zone **still** applies for the first 10 minutes of aeration.

NOTICE

USDA-APHIS granted the State of California a waiver from the 200' aeration buffer zone requirement provided the following criteria are met:

- ◆ The local CA Department of Pesticides or local Air Pollutions Department has issued a local permit allowing less than 200' aeration buffer zone.
- ◆ The permit applies only to a chamber with a vertical aeration stack.

USDA-APHIS may consider other waivers on a case-by-case basis.

The fumigator **must** refer to EPA's website to determine the minimum aeration buffer zone to be maintained until the aeration period is complete and the fumigator has verified that gas concentration levels meet the conditions in the MB label.

Transiting through buffer zones

The label permits vehicles to transit through both treatment and aeration buffer zones under specific conditions found in the label; it is up to the fumigator determine how or whether vehicles may transit in accordance with the label.

When using the newer 2016 MB label, changes to certain procedures and equipment in this chapter are displayed in a NOTICE box with a heading titled "MB 2016 Label".

MB 2016 Label (example)

NOTICE

Use this information when the fumigator is using the 2016 MB label.

When using existing stocks, follow the equipment and procedural guidance that is displayed in the **body** of the text (**outside** of the NOTICE box).

If there is no “MB 2016 Label” NOTICE box, then the instructions apply to all MB labels, 2016 and older.

Materials Needed

PPQ Official Provides

- ◆ APHIS-approved leak detection device
- ◆ Calculator (optional)
- ◆ Forms (PPQ Form 429A and APHIS Form 2061 if necessary)
- ◆ Self-contained breathing apparatus (SCBA) or supplied air respirator

MB 2016 Label

NOTICE

In addition to the bulleted equipment list required from PPQ, PPQ must also provide:

- ◆ Air purifying respirator NIOSH certified half-mask or full face piece with a cartridge for concentrations between 1 and 4 ppm
- ◆ APHIS-approved continuous real time gas monitoring device
 - ❖ Permanently mounted in PPQ owned facilities only, PureAire Monitoring Systems, Inc., model Air Check Advantage. The Air Check Advantage can be calibrated either by the manufacturer or by the PPQ official. Calibrate according to the manufacturer's User Guide. Refer to Chapter 8: Equipment for more information.
 - ❖ Portable Photoionization Detector (PID), RAE Systems, Inc. model MiniRAE 3000. The MiniRAE 3000 must be calibrated by the PPQ official according to the manufacturer's User Guide. Refer to Chapter 8: Equipment for more information.
- ◆ Self contained breathing apparatus (SCBA) NIOSH approval prefix TC-13F or supplied air respirator NIOSH approval prefix TC-19C

Fumigator Provides

- ◆ APHIS-approved gas detection device² (e.g. thermal conductivity device, infrared device, etc.)
- ◆ APHIS-approved leak detection device
- ◆ Auxiliary pump for purging long gas sample tubes
- ◆ Carbon dioxide filter (e.g. Ascarite®)
- ◆ Colorimetric tubes (Refer to Appendix E for a list of APHIS-approved product ranges)
- ◆ Desiccant (e.g. Drierite®)
- ◆ Electrical wiring (grounded, permanent type), three prong extension cords
- ◆ Gas introduction line
- ◆ Heat supply

2 The methyl bromide monitor must be calibrated annually. Refer to Chapter 8: Equipment for calibration information. If using a thermal conductivity (TC) analyzer, Drierite® and Ascarite® must be used.

- ◆ Methyl bromide
- ◆ Scale or graduated cylinder for volume (liquid measurements)³
- ◆ SCBA or supplied air respirator
- ◆ Temperature recorder and temperature sensors⁴
- ◆ Thermometer⁵
- ◆ Volatilizer
- ◆ Warning signs/placarding

MB 2016 Label

NOTICE

In addition to the bulleted equipment list required from the fumigator, the fumigator must also provide:

- ◆ Air purifying respirator NIOSH certified half-mask or full face piece with a cartridge for concentrations between 1 and 4 ppm
- ◆ APHIS-approved direct read gas detection device
 - ❖ Colorimetric tubes (e.g. Draeger, Sensidyne)
- ◆ APHIS-approved continuous real time gas monitoring device
 - ❖ Permanently mounted in PPQ owned facilities only, PureAire Monitoring Systems, Inc., model Air Check Advantage
 - ❖ Portable Photoionization Detector (PID), RAE Systems, Inc. model MiniRAE 3000
 - ❖ Devices **must** be calibrated according to the manufacturer's User Guide. Refer to Chapter 8: Equipment for more information.
- ◆ Self contained breathing apparatus (SCBA) NIOSH approval prefix TC-13F or supplied air respirator NIOSH approval prefix TC-19C

3 All scales must be calibrated by the State, a company that is certified to conduct scale calibrations, or by the fumigator under the supervision of PPQ. The source and date of calibration must be posted in a visible location on or with the scale at all times. The scale must be calibrated a following every repair or minimum of every year.

4 Temperature sensors must be calibrated annually by the manufacturer or National Institute of Standards and Technology (NIST) within the range of 40 °F to 80 °F (4.4 °C to 26.7 °C)

5 The thermometer must be calibrated or replaced annually.

Conducting the Fumigation

Step 1: Selecting a Treatment Schedule

The PPQ official will select an appropriate treatment schedule to effectively eliminate the plant pest **without** damaging the commodity to be fumigated.

Turn to the treatment schedule index and look up by commodity or by pest the treatment schedule(s) available. Treatment schedules which are approved for chambers will be listed as either “NAP” (normal atmospheric pressure) or as “vacuum.”

Step 2: Issuing a PPQ Form 523 (Emergency Action Notification)

When an intercepted pest is identified and confirmed by a PPQ Area Identifier as requiring action, the CBP or PPQ official will issue a Form 523 (Emergency Action Notification - EAN) to the owner, broker, or representative. The EAN will list all treatment options. Refer to Appendix A in the Manual for Agricultural Clearance for instructions on completing and distributing the EAN.

Step 3: Determining Section 18 Exemptions and Sampling Requirements

After selecting the treatment schedule, the PPQ official will determine which treatment schedules are FIFRA Section 18 Exemptions. The schedule will be followed by an “IMPORTANT” note to help you determine the current exemption status. Some treatment schedules are only FIFRA Section 18 Exemptions at specific temperature ranges. Check the treatment schedule and temperature to determine if the fumigation will be a FIFRA Section 18 Exemption.

Residue monitoring by taking samples of the commodity prior to the start of the fumigation and after aeration is **no** longer required.

Step 4: Setting up the Fumigation Site

MB 2016 Label

NOTICE

The PPQ official and the fumigator must select a secure area where traffic and people are restricted from entering and which is isolated from people working. A nonwork area is preferred to help prevent accidents.

The treatment and aeration buffer zones are determined by the fumigator in accordance with EPA’s fumigation buffer zone tables. [<https://www.epa.gov/pesticide-registration/mbcommoditybuffer>]

The buffer zones surround the area where access is limited during treatment. If the fumigator determines that the buffer zone is less than 30’, then PPQ requires a 30’ buffer zone. If the fumigator determines that the buffer zone is greater than 30’, then PPQ must observe the prescribed buffer zone.

The treatment and aeration buffer zones extend from the perimeter of the enclosure to a distance determined by the fumigator in accordance with the label. Entry by any person except the PPQ official and the fumigator is prohibited except as provided in the “Exceptions to Buffer Zone Entry Restrictions” section of the label.

The treatment buffer zone begins when the fumigant is introduced into the enclosure and ends when aeration begins, at which point the aeration buffer zone requirements apply.

The fumigator must define the treatment and aeration buffer zone perimeters using physical barriers (such as walls, ropes, etc.) and placards to limit access to the buffer zone. Placards must meet all label requirements regarding specific warnings, information, and language.

The fumigator will permit transiting through buffer zones in accordance with the “Transit Exception” section of the label.

Buffer Zone Overlap for Multiple Enclosures

For multiple enclosures where buffer zones overlap, the fumigator must recalculate both the treatment and aeration buffer zones in accordance with the label and supply them to the PPQ official.

Step 5: Measuring the Temperature

The PPQ official **must** determine the temperature of the commodity in order to select the proper dosage rate. Depending on whether or not you are fumigating a pulpy fruit or vegetable, you may use **either** the commodity temperature **or** an average of the commodity and air temperatures. A pulpy fruit or vegetable can support internal feeding insects, is fleshy and moist, and can be probed with a temperature measuring device. Examples include, but are **not** limited to peppers, onions, and grapes.

Determine the temperature to use in selecting the proper dosage rate:

- ◆ For fruits, pulpy vegetables, or logs use **only** the commodity temperature.
- ◆ For all other commodities, use **both** the commodity and air temperature.

To take the temperature readings, use a bimetallic, mercury, or digital long-stem thermometer that has been calibrated. Use [Table 2-5-1](#) to determine which temperature to use when selecting the proper dosage rate for commodities **other than** fresh fruits, vegetables, or logs. Record the temperatures in Block 22 of the PPQ Form 429A.

In the electronic 429 database, record the temperatures in the space and commodity fields in the Treatment form.

NOTICE

Commodity and space temperatures **must** be 40 °F or above.

CAUTION

The presence of ice indicates temperatures below 40 °F. If ice is present anywhere in the box, pallet, or fumigation enclosure, **DO NOT** fumigate the commodity.

Table 2-5-1 Determine Whether to Use Commodity or Air Temperature for Determining Dosage Rate

If the air temperature is:	And:	Then, for commodities other than fresh fruits or vegetables or logs and lumber ¹ :
Higher than the commodity temperature		Use the single lowest commodity temperature for determining the dosage rate (do not use the average commodity temperature.)
Lower than the commodity temperature	By less than 10 degrees	
	By 10 degrees or more	Use the average of the air and commodity temperature for determining the dosage rate.

1 Use commodity temperature for fresh fruits or vegetables or logs and lumber.

Step 6: Calculating the Dosage

In order to calculate the dosage, the PPQ official must have the following information:

- ◆ Temperature of commodity and air (°F)
- ◆ Treatment schedule
- ◆ Volume of the fumigation chamber (ft³)

The PPQ official must refer to the specific treatment schedule to determine the dosage rate (pounds/ft³).

Refer to the formula in [Figure 2-5-1](#) for calculating dosage:

$$\text{Dosage (lbs.)} = \frac{\text{Volume (ft}^3\text{)} \times \text{Dosage Rate (lbs.)}}{1,000 \text{ ft}^3}$$

Figure 2-5-1 Formula for Calculating MB Dosage for Chamber Fumigations

EXAMPLE Using a fumigation chamber which has a volume of 500 ft³, you determine the temperature of the commodity and space is 72 °F. The treatment schedule requires 2 lbs. MB/1,000 ft³ at 70 °F or above. To calculate dosage multiply the volume (500 ft³) by the dosage rate (2 lbs. MB/1,000 ft³). This equals 1.0 lbs. of MB needed for the dosage.

Step 7: Conducting the Fumigation

Since fumigation chambers vary by manufacturer and model, refer to the manufacturer's operating manual to determine how to use the chamber. In NAP chambers, run circulation fans for 15 minutes following introduction of the gas.

Taking concentration readings is **not** required when conducting chamber fumigations.

Step 8: Leak Detection

Turn on any leak detection devices prior to gas introduction and ensure that they run throughout the entire fumigation and aeration.

Aeration

The fumigator must:

- ◆ Arrange for the aeration to proceed once the treatment is completed.
- ◆ Consider the wind direction when pointing the exhaust duct, and face the duct outlet toward an open area away from people.
- ◆ Ensure that, during the first 10 minutes of aeration, no one is present within 200 feet downwind of the exhaust duct outlet (see California waiver details on page 2-5-2).
- ◆ Determine aeration buffer zones in accordance with EPA's fumigation buffer zone tables (<https://www.epa.gov/pesticide-registration/mbcommoditybuffer>).
- ◆ Ensure no one is present within the perimeter of the aeration buffer zone unless they are wearing SCBA.
- ◆ Refer to "Buffer Zone Overlap for Multiple Enclosures".
- ◆ Follow all label instructions, state, county, and local regulations, in addition to the instructions in this manual.
- ◆ Inform people located in occupied structures and personnel in the immediate area within the buffer zone that release of MB is about to take place and give them the option of leaving the area or remaining inside the building.

- ◆ Restrict access to the area where the exhaust duct extends beyond the enclosure.
- ◆ Secure the fumigation area and allow only the chamber operator and the PPQ official monitoring the fumigation into the secure area.

WARNING
Do not allow motorized vehicles to operate within the secure area.

Responsibility for Aerating the Commodity

Responsibility for aerating the chamber and releasing the commodity depends on whether the treatment schedule used was a labeled use or FIFRA Section 18 exemption. Use [Table 2-5-2](#) to determine responsibility for aerating the commodity.

Table 2-5-2 Determine the Responsibility for Aerating the Commodity During Chamber Fumigations

If the fumigation chamber is:	And the treatment schedule is:	Then:
Privately or State owned	A labeled treatment	RELEASE the fumigation to the fumigator to aerate and release the commodity.
	A FIFRA Section 18 Exemption (noted in the treatment schedules)	1. PPQ official must be present at the initiation of aeration, and to verify the final aeration readings. 2. USE Table 2-5-3 to determine which aeration procedures to follow
PPQ owned		

Use [Table 2-5-3](#) to determine which procedures to follow for aerating normal atmospheric pressure (NAP) and vacuum chambers.

Table 2-5-3 Determine the Aeration Procedure for Chamber Fumigations

If the chamber is:	Then:
NAP	Use the procedures on page 2-5-12 .
Vacuum	Use the procedures on page 2-5-13 .

Each chamber **must** be equipped with at least one permanent, metal gas sampling tube to allow the fumigator to take colorimetric tube readings during the aeration. Any extensions of the gas sampling tube or flexible connectors **must** be made of Teflon™ tubing or metal. The extensions of the sampling tube **must** run from an area in between the treated boxes and end outside the chamber to allow for colorimetric tube readings.

Wearing Respiratory Protection

The fumigator **must** wear approved respiratory protection (SCBA, supplied air respirator, or a combination unit) when there is a risk of exposure to concentrations above 5 ppm; this includes any time the concentration is unknown.

MB 2016 Label

NOTICE

If MB concentration levels are between 1-4 ppm, the PPQ official and the fumigator may wear an air purifying respirator NIOSH certified half-mask or full face piece with a cartridge.

Normal Atmospheric Pressure Chamber—Aerating Noncontainerized Cargo

Advise the fumigator to:

1. While wearing SCBA, turn on the chamber fans.
2. Aerate a minimum of 3 hours for all commodities.
3. Stop the fans and take concentration readings with colorimetric tubes in the airspace around and, when feasible, **within the carton or box**.

Use [Table 2-5-4](#) to determine when to release the commodity.

Table 2-5-4 Determine When to Release the Commodity After NAP Fumigation

If the gas concentration is:	Then:
5 ppm or less	<ol style="list-style-type: none">1. CONTINUE aeration for 30 minutes.2. REQUIRE the fumigator to confirm that gas concentrations remain at 5 ppm or less.3. RELEASE commodity.
6 ppm or more	<ol style="list-style-type: none">1. REQUIRE the fumigator to conduct two additional air washes.2. TAKE gas concentration readings.3. If concentration readings are 5 ppm or less, CONTINUE aeration for 30 minutes.4. REQUIRE the fumigator to confirm that gas concentrations remain at 5 ppm or less.5. RELEASE the commodity.

For FIFRA Section 18 exemptions, record the concentration reading (in ppm), date, and time in Block 39 of PPQ Form 429A. In the electronic 429 database, record the date, time, and detector reading (ppm) in the “Detector Readings” form.

Vacuum Fumigation Chambers—Aerating Containerized and Noncontainerized Cargo

Advise the fumigator to:

1. Adjust any vacuum remaining at the end of the fumigation to zero by temporarily opening the air intake valve, then closing it.
2. Draw a 15 inch vacuum and adjust it to zero.
3. Repeat this process of drawing a 15 inch vacuum and releasing it a **minimum of four times**.
4. Take concentration readings using a colorimetric tube in the airspace around and, when feasible, **within the carton or box**.

For FIFRA Section 18 exemptions, record the concentration reading (in ppm), date, and time in Block 39 of PPQ Form 429A. In the electronic 429 database, record the date, time, and detector reading (in ppm) in the “Detector Readings” form.

Use [Table 2-5-5](#) to determine when to release the commodity.

Table 2-5-5 Determine When to Release the Commodity After Vacuum Fumigation

If the gas concentration is:	Then:
5 ppm or less	<ol style="list-style-type: none">1. CONTINUE aeration for 30 minutes.2. REQUIRE the fumigator to confirm that gas concentrations remain at 5 ppm or less.3. RELEASE commodity.
6 ppm or above	<ol style="list-style-type: none">1. REQUIRE the fumigator to conduct two additional air washes.2. TAKE gas concentration readings.3. If concentration readings are 5 ppm or less, CONTINUE aeration for 30 minutes.4. REQUIRE the fumigator to confirm that gas concentrations remain at 5 ppm or less.5. RELEASE the commodity.

Chemical Treatments

Fumigants—Methyl Bromide—Ship Fumigation for Emergency Situations

Contents

Methods and Procedures	2-6-1
2016 Methyl Bromide Label Information	2-6-1
Materials Needed	2-6-3
PPQ Official Provides	2-6-3
Fumigator Provides	2-6-3
Taking Safety Measures When Fumigating Ships	2-6-5
Preparing to Fumigate	2-6-6
Conducting the Fumigation	2-6-11
Aeration	2-6-14
Wearing Respiratory Protection	2-6-15

Methods and Procedures

The procedures covered in this section provide the methods, responsibilities, and precautions for the fumigation of dry stores, galleys, and crew quarters infested with Khapra beetle and other pests that require treatment.

Emergency fumigation for other pests and commodities may be approved on a case-by-case basis. Contact USDA-APHIS-PPQ Field Operations at PPQ.Ops.Treatment@usda.gov for more information.

Even though ship fumigations are allowed by the manufacturers of methyl bromide, APHIS policy PROHIBITS fumigation of bulk commodities in the ship hold because of the difficulty in meeting APHIS standards.

2016 Methyl Bromide Label Information

In 2015, the Environmental Protection Agency (EPA) directed all methyl bromide (MB) registrants to amend the use directions on the labels of all 100% MB products. EPA required the changes in order to reflect recommendations in an EPA report.¹

¹ "Report of Food Quality Protection Act (FQPA) Tolerance Reassessment and Risk Management Decision (TRED) for methyl bromide, and Reregistration Eligibility Decision (RED) for Methyl Bromide's Commodity Uses", archive dated August 2006.

These amendments modify the use directions for fumigation and aeration procedures, modify respiratory requirements and equipment and update gas monitoring equipment. EPA requires all labels on newly manufactured MB to reflect these recommendations effective **October 01, 2016**; however, EPA is allowing existing stocks of MB to be used in accordance with the use directions on the existing stock's (older) labels.

PPQ officials and fumigators **must** closely examine gas cylinder labels in order to validate that the dosage, exposure, and commodity are either on the cylinder label or covered by a FIFRA Section 18 exemption. If a label is **not** affixed to the cylinder, **DO NOT** allow the fumigator to use that cylinder.

New Buffer Zone Requirements

All 2016 MB labels now require both a treatment and an aeration buffer zone. Both the treatment and aeration buffer zones are specific to the enclosure being fumigated and must be determined by tables in the [Environmental Protection Agency \(EPA\) Methyl Bromide Commodity Fumigation Buffer Zone Lookup Tables](#). The fumigators are responsible for using this website to determine the buffer zones and reporting both buffer zones to the PPQ official. If the treatment buffer zone is determined to be less than 30 feet, the PPQ official will maintain PPQ's standard 30 foot treatment buffer zone; otherwise, the new treatment buffer zone **must** be observed. If the aeration buffer zone is determined to be less than 200 feet, then PPQ's standard "200 feet for 10 minutes" aeration buffer zone **still** applies for the first 10 minutes of aeration. The fumigator **must** refer to EPA's website to determine the minimum aeration buffer zone to be maintained until the aeration period is complete and the fumigator has verified that gas concentration levels meet the conditions in the MB label.

Transiting through buffer zones

The label permits vehicles to transit through both treatment and aeration buffer zones under specific conditions found in the label; it is up to the fumigator determine how or whether vehicles may transit in accordance with the label.

When using the newer 2016 MB label, changes to certain procedures and equipment in this chapter are displayed in a NOTICE box with a heading titled "MB 2016 Label".

MB 2016 Label (example)

NOTICE

Use this information when the fumigator is using the 2016 MB label.

When using existing stocks, follow the equipment and procedural guidance that is displayed in the **body** of the text (**outside** of the NOTICE box).

If there is no “MB 2016 Label” NOTICE box, then the instructions apply to all MB labels, 2016 and older.

Materials Needed

PPQ Official Provides

- ◆ APHIS-approved leak detection device
- ◆ Calculator (optional)
- ◆ PPQ Form 429A and the electronic 429 database
- ◆ SCBA or supplied air respirator

MB 2016 Label

NOTICE

In addition to the bulleted equipment list required from PPQ, PPQ must also provide:

- ◆ Air purifying respirator NIOSH certified half-mask or full face piece with a cartridge for concentrations between 1 and 4 ppm
- ◆ APHIS-approved continuous real time gas monitoring device
 - ❖ Permanently mounted in PPQ owned facilities only, PureAire Monitoring Systems, Inc., model Air Check Advantage. The Air Check Advantage can be calibrated either by the manufacturer or by the PPQ official. Calibrate according to the manufacturer’s User Guide. Refer to Chapter 8: Equipment for more information.
 - ❖ Portable Photoionization Detector (PID), RAE Systems, Inc. model MiniRAE 3000. The MiniRAE 3000 must be calibrated by the PPQ official according to the manufacturer’s User Guide. Refer to Chapter 8: Equipment for more information.
- ◆ Self contained breathing apparatus (SCBA) NIOSH approval prefix TC-13F or supplied air respirator NIOSH approval prefix TC-19C

Fumigator Provides

- ◆ Adhesive sealer, tape, and putty or other pliable material for sealing off holes around pipes

- ◆ APHIS-approved gas detection device² (e.g. thermal conductivity device, infrared device, etc.)
- ◆ Auxiliary pump for purging long gas sample tubes
- ◆ Carbon dioxide filter (Ascarite®)
- ◆ Colorimetric tubes (Draeger/Kitagawa)
- ◆ Dessicant (Drierite®)
- ◆ Electrical wiring (ground, permanent type), three prong extension cords
- ◆ Exhaust blower and ducts
- ◆ Fans (circulation, exhaust, and introduction)
- ◆ Framework and supports
- ◆ Gas sampling tubes (leads)
- ◆ Gas supply line
- ◆ Heat supply
- ◆ Insecticides and spray equipment
- ◆ Methyl bromide
- ◆ Padding
- ◆ Sand or water snakes
- ◆ Scales or dispensers³
- ◆ SCBA or supplied air respirator
- ◆ Tape
- ◆ Tarpaulin and supports
- ◆ Temperature recorder and temperature sensors⁴
- ◆ Thermometer⁵
- ◆ Volatilizer
- ◆ Warning signs

2 The methyl bromide monitor must be calibrated annually. Refer to Chapter 8: Equipment for calibration information. If using a thermal conductivity (TC) analyzer, Drierite® and Ascarite® must be used.

3 All scales must be calibrated by the State, a company that is certified to conduct scale calibrations, or by the fumigator under the supervision of PPQ. The source and date of calibration must be posted in a visible location on or with the scale at all times. The scale must be calibrated a following every repair or minimum of every year.

4 Temperature sensors must be calibrated annually by the manufacturer or National Institute of Standards and Technology (NIST) within the range of 40 °F to 80 °F (4.4 °C to 26.7 °C)

5 The thermometer must be calibrated or replaced annually.

The PPQ official and the fumigator should be prepared to use auxiliary power if shore power is not available as most ships' power is 220 volts.

MB 2016 Label

NOTICE

In addition to the bulleted equipment list required from the fumigator, the fumigator must also provide:

- ◆ Air purifying respirator NIOSH certified half-mask or full face piece with a cartridge for concentrations between 1 and 4 ppm
- ◆ APHIS-approved direct read gas detection device
 - ❖ Colorimetric tubes (e.g. Draeger, Sensidyne)
- ◆ APHIS-approved continuous real time gas monitoring device
 - ❖ Permanently mounted in PPQ owned facilities only, PureAire Monitoring Systems, Inc., model Air Check Advantage
 - ❖ Portable Photoionization Detector (PID), RAE Systems, Inc. model MiniRAE 3000
 - ❖ Devices **must** be calibrated according to the manufacturer's User Guide. Refer to Chapter 8: Equipment for more information.
- ◆ Self contained breathing apparatus (SCBA) NIOSH approval prefix TC-13F or supplied air respirator NIOSH approval prefix TC-19C

Taking Safety Measures When Fumigating Ships

The most important consideration when fumigating ships is the protection of human life. The commercial fumigator has the following safety responsibilities when fumigating ships:

- ◆ Conduct fumigation properly to result in an effective treatment
- ◆ Evacuate gas from ship and aerate when fumigation is completed
- ◆ Observe all safety precautions while fumigating
- ◆ Prevent access of unauthorized personnel, including the ship's crew, to the fumigated area
- ◆ Test with a gas detector, all areas aboard ship to ensure freedom from MB before allowing crew members access to the ship

The commercial fumigator **must** abide by the following guidelines when fumigating ships:

- ◆ Have a representative present throughout the entire fumigation. The representative **must** be familiar with directions for using the fumigant, warnings, antidotes, etc., shown on the label, on the gas cylinder, and contained in the manufacturer’s application manual.
- ◆ Have adequate first-aid equipment, SCBA, and other safety equipment available
- ◆ Have all areas of the ship tested with a gas detector prior to crew reentry. Pay particular attention to all fumigated areas, crew quarters, and the engine rooms
- ◆ Provide for immediate contact with the responsible ship’s officer to provide information and access to areas of the ship which may be needed to assure a safe fumigation

Preparing to Fumigate

Step 1: Meeting with Ship’s Captain and Agent

When planning a ship fumigation, the PPQ official must meet with the ship’s captain, agent, and the fumigation company representative to discuss the conditions of the fumigation. If cargo is present in an area about to be fumigated, determine if any materials might be adversely affected by the fumigant (see [Residual Effect](#) on page 2-3-11 for a list of commodities adversely affected by MB.) Notify the ship’s agent of possible effects and if conditions permit, allow removal of the material for an alternate treatment.

Discuss plans for removing all crew from the ship. Prior to fumigating a vessel, the master of the vessel and the fumigator **must** determine whether it is suitably designed to allow for safe occupancy by the ship’s crew. If it is determined that it does **not** allow for safe occupancy, then all crew members **must** be removed.

It is the responsibility of the commercial fumigator to comply with all label requirements, and with State, local, and U.S. Coast Guard regulations (See [Coast Guard Regulations](#) on page B-1-1) concerning shipboard fumigation.

Step 2: Selecting a Treatment Schedule

Refer to [T402—Containers, Ships, and Surrounding Areas](#) for the correct treatment. Select a treatment schedule based on the plant pest and commodity to be fumigated. Consider all the commodities present in the area to be fumigated when determining the best treatment available. In the case of Khapra beetle fumigation, determine if finely milled products (example—flour) will be fumigated. To ensure all life stages have been mitigated, have all fumigated commodities destroyed either by incineration or sterilization after the fumigation has been completed.

Treating Deck Areas

Areas which may be pest contaminated or suspected of being contaminated, such as the deck, hatch covers, drain channels, crevices around hatches, hallways, and similar areas that **cannot** be fumigated, should be treated according to [T402-b-3-1 Pest: Trogoderma granarium \(Khapra Beetle\)](#).

Step 3: Determine Buffer Zones

MB 2016 Label

NOTICE

The fumigator will determine the treatment buffer zone in accordance with the [Environmental Protection Agency \(EPA\) Methyl Bromide Commodity Fumigation Buffer Zone Lookup Tables](#).

The treatment buffer zone surrounds the area where access is limited during treatment. If the fumigator determines that the buffer zone is less than 30', then PPQ requires a 30' buffer zone. If the fumigator determines that the buffer zone is greater than 30', then PPQ must observe the prescribed buffer zone.

The treatment buffer zone extends from the perimeter of the enclosure to a distance determined by the fumigator in accordance with the label. Entry by any person except the PPQ official and the fumigator is prohibited except as provided in the "Exceptions to Buffer Zone Entry Restrictions" section of the label.

The treatment buffer zone begins when the fumigant is introduced into the enclosure and ends when aeration begins, at which point the aeration buffer zone requirements apply.

The fumigator must define treatment and aeration buffer zone perimeters using physical barriers (such as walls, ropes, etc.) and placards to limit access to the buffer zone. Placards must meet all label requirements regarding specific warnings, information, and language.

The fumigator will permit transiting through buffer zones in accordance with the "Transit Exception" section of the label.

Buffer Zone Overlap for Multiple Enclosures

For multiple enclosures where buffer zones overlap, the fumigator must recalculate both the treatment and aeration buffer zones in accordance with the label and supply them to the PPQ official.

Step 4: Preparing Areas to be Fumigated

Open all bins, drawers, and cupboards. Stack all bagged commodities on pallets to facilitate gas distribution and penetration.

Step 5: Arranging and Operating Fans

Storerooms normally require a minimum of two, 1,800 cfm fans. Ensure that the fumigator places one fan at a low level and the other at a high level. Fans with capacity above 1,800 cfm create strong air currents which could result in gas leakage around the seals. If you are fumigating an area which includes the galley and adjoining storerooms, ensure that the fumigator places the fans to evenly distribute gas. Make certain that fans can be turned on and off from an area outside the fumigation site.

Require the fumigator to test all fans to ensure that they are in good operating condition. Operate fans during the gas introduction and for 30 minutes after introduction is completed.

Step 6: Placing Gas Sampling Tubes

The fumigator must place gas sampling tubes in areas and commodities which will give representative samples within the fumigated area. Require the fumigator to bring all tubes to one central point outside the treatment buffer zone of the area being fumigated. Label all gas sampling tubes so they can be easily identified when you take concentration readings. Label each tube by identifying the level of the hold and whether the gas sampling tube is in a commodity or space.

The fumigator must place a minimum of two gas sampling tubes in open space and at least one gas sampling tube within the commodity considered to be the most difficult for the fumigator to penetrate.

Step 7: Placing the Gas Introduction Lines

Numerous gas introduction lines may be necessary in order to obtain even gas distribution throughout the fumigation area. Require the fumigator to place the gas introduction line directly through an opening from the outside (example—a door or window) directly above a fan. The introduction line must be securely attached to the top of the fan to prevent movement of the hose. An unsecured introduction line could move the line out of the airflow. Require the fumigator to place a piece of nonpermeable sheeting (example—plastic or vinyl) over the commodity in front of and below each gas supply line. The nonpermeable sheet will prevent any liquid MB from coming in contact with commodities and will prevent damage.

Step 8: Measuring the Temperature

The PPQ official **must** determine the temperature of the commodity and the air (space) in order to select the proper dosage rate using a calibrated thermometer. Record the temperatures in Block 22 on the PPQ Form 429A.

In the electronic 429 database, record the temperatures in the space and commodity fields in the Treatment form.

If the temperature is below the minimum listed for the treatment schedule, then require the fumigator to heat the hold or other space to be fumigated.

Step 9: Sealing Stores

One of the most important steps in preparing for a ship fumigation is sealing all openings and areas which have the potential to leak gas. Consider the entire area to be fumigated as a natural atmospheric chamber and make the area as gas tight as possible. The most important task is to locate all openings (e.g., drain pipes, bilge drain holes, or air ducts) and seal them.

Ensure that the fumigator does **not** seal or make gas tight recessed areas, ducts, or similar apertures which may harbor an infestation. In some cases, it is better to seal sources of leaks on the outside of the area to be fumigated. Require the fumigator to use caulking compound or tape for sealing small spaces, doors, and other openings. For sealing larger areas, such as hatch cover openings, use polyethylene or similar material secured with tape or adhesive spray. When practical, seal air ventilation ducts on the outside of the space being fumigated so sealing tape can be removed when the fumigator evacuates the gas and begins aeration.

Require the fumigator to look for and seal off the following ship areas when preparing a ship for fumigation:

- ◆ Air vents
- ◆ All passageways, engine room, and other crew areas for electric pipeline or other duct work common with cargo holds
- ◆ Bilge and drainwell vents and drains to all cargo holds sometimes common with more than one hold or engine room bilges
- ◆ CO₂ piping to all cargo holds; degassing systems (older ships) which usually run from hold to hold
- ◆ Drains
- ◆ Dumbwaiter openings
- ◆ Emergency escape hatches from shaft alley and escape hatches from all holds
- ◆ Engine room—recirculation air systems controlled from and common with the engine room areas—especially on newer ships; check for drilled holes or other openings in fore and aft bulkheads of engine room spaces, all engine room vent systems, and housing or casing leading into spaces to be fumigated
- ◆ Galley intake and exhaust systems (may be common with the dry stores)
- ◆ Heating, air conditioning, electrical, communication, and ventilation systems

- ◆ Inner bottom and deep tank covers to ensure that they are closed prior to fumigating
- ◆ Pipes and other utility conduits through decks and bulkheads
- ◆ Fire and smoke detector systems from fumigated areas
- ◆ Steam-smothering systems for connection between holds
- ◆ Vents in shaft alley and gear lockers to holds; breaks in bulkhead
- ◆ Wall plates

Step 10: Measuring Volume

Obtain the volume of the dry stores, galleys, and crew quarters from the chief mate, captain, the ship's plan, or by measuring the actual dimensions.

Step 11: Calculating Dosage

Use the formula in [Figure 2-6-1](#) to calculate dosage.

$$\text{Dosage (lbs.)} = \frac{\text{Volume (ft}^3\text{)} \times \text{Dosage Rate (lbs.)}}{1,000 \text{ ft}^3}$$

Figure 2-6-1 Formula for Calculating MB Dosage for Vessel Fumigations

EXAMPLE The dry storage area is infested with Khapra beetle. The volume is 8,000 ft³, and the temperature is 65 °F. The treatment schedule lists the dosage rate as 6 lbs. MB/1,000 ft³. To calculate the dosage, multiply the volume (8,000 ft³) by the dosage rate (6 lbs./1,000 ft³). This equals 48 lbs. of MB needed for the dosage.

Step 12: Making a Final Check

Just before introducing the gas, the PPQ official and the fumigator **must** ensure that the following activities are performed:

- ◆ Check all sealed areas to make sure they are securely taped and free from holes
- ◆ Check the gas introduction line connections to make sure they are tight
- ◆ Check to make sure all safety equipment is available and in working order
- ◆ Check to make sure the ship's gangway and areas to be fumigated are properly placarded and the area is secured. A guard should be present at the entrance to the gangway to restrict access to the ship. If the crew has been removed, walk through the quarters and other areas to make sure **no** one is on board

- ◆ Place fumigant cylinder with gas introduction line on scale and take initial weight reading. Make sure the gas introduction line is attached to the cylinder. After obtaining the correct weight, subtract the dosage to be introduced into the enclosure. When the entire dosage has been introduced, the scale will be balanced.
- ◆ Start volatilizer and heat water to 200 °F or above
- ◆ Take gas concentration readings to determine if any contaminant gases are present
- ◆ Turn on all fans and gas detection devices to make sure they work

Conducting the Fumigation

Step 1: Introducing the Gas

CAUTION

The PPQ official **must** wear the SCBA anytime the MB concentration level in the air is unknown or greater than or equal to 5 ppm.

MB 2016 Label

NOTICE

If MB concentration levels are between 1-4 ppm, the PPQ official and the fumigator may wear an air purifying respirator NIOSH certified half-mask or full face piece with a cartridge.

Require the fumigator to use SCBA while introducing and adding gas. Require the fumigator to turn on all fans while introducing the gas. When using large cylinders of MB, have the fumigator slightly open the valve then close the valve. Using an APHIS-approved continuous real time gas detection device, check all connections on the gas introduction line for leaks. If leaks are found, the fumigator must tighten the connections and repeat the test. When **no** leaks are found, require the fumigator to open the valve to the point where 3 to 4 pounds of MB are being introduced per minute. The water temperature in the volatilizer should never go below 150 °F at any time during gas introduction. The water in the volatilizer can include an antifreeze and should be handled with appropriate safeguards.

CAUTION

Do **not** touch the introduction line with your bare hands—you may get burned! Have the fumigator close the cylinder valve once the proper dosage has been introduced.

The fumigation time begins when all the gas has been introduced. The PPQ official must record the time gas introduction was started and completed in Block 32 on the PPQ Form 429A.

In the electronic 429 database, record the fumigation date, gas introduction start and finish time in the corresponding fields under the “GAS INTRODUCTION” heading on the Treatment form.

Require the fumigator to run the fans for 30 minutes after all the gas has been introduced. The PPQ official must take the initial concentration reading 30 minutes after all the gas has been introduced.

When using cylinders, getting the final amounts of gas out of the cylinder may take a long time. Consider taking gas concentration readings 30 minutes after the gas is first introduced. If the gas distribution is even (all readings within 4 ounces of each other) and at an adequately high concentration, then require the fumigator to turn off the fans. Running the fans longer may contribute to gas leakage. Allow the remainder of the gas to discharge at its slow rate with intermittent running of the fans for dispersal.

Step 2: Taking Concentration Readings

The PPQ official **must** take concentration readings with an APHIS-approved gas detection device to determine the gas concentration and distribution within the area being fumigated. If using a T/C, check Drierite® tubes before each reading and change Drierite® if its color is pink. Take concentration readings at the times prescribed in the treatment schedule.

Consult the treatment schedule being used for the actual concentration readings. You may start the final concentration reading 30 minutes prior to the end of the exposure period.

Take additional readings when there is indication that the gas is **not** properly distributed or the minimum gas concentration is **not** being maintained. Record readings on PPQ Form 429A.

Step 3: Testing for Leaks

Require the fumigator to wear the SCBA and use an APHIS-approved continuous real time gas detection device to test for leaks after all the gas has been introduced. Test around the perimeter of the area being fumigated, especially where doors, windows, pipes, electric cords, gas sampling tubes, and gas introduction lines are present. If the fumigator detects leaks, ensure they are sealed with additional tape, adhesive, or by placing more polyethylene and adhesive over the leaking areas.

Step 4: Adding Gas and Extending Exposure

If you determine that you need to add gas and extend time, use the formula in [Figure 2-6-2](#) to calculate the amount of gas to add and [Table 2-6-1](#) to determine how long to extend the exposure period.

$$1.6 \times \text{number of ounces below minimum} \times \frac{\text{volume in cubic feet}}{1000 \text{ cubic feet}} \times \frac{1}{16} = \text{pounds of gas to add}$$

Figure 2-6-2 Formula for Determining the Amount of Gas to Add for Vessel Fumigation

EXAMPLE You are fumigating a ship's storeroom for Khapra beetle and the minimum concentration for the 2-hour reading is listed at 50 oz., but your readings average 45 oz. The volume of the storeroom is 1,500 ft³. Using the formula in [Figure 2-6-2](#), you would figure the following:

$$1.6 \times 5 \text{ (oz. below minimum)} \times 1,500/1,000 \\ 8 \times 1.50 = 12 \text{ oz. gas to be added}$$

Use [Table 2-6-1](#) to determine how long to extend the exposure period:

Table 2-6-1 Determine Time for Extended Exposure

If the exposure time is:	And the reading is below minimum by:	Then extend exposure:
12 hours or more	10 oz. or less	10 percent of the time lapse since gas introduction or the last reading
	11 oz. or more	2 hours or 10 percent of the time lapse since last reading, whichever is greater

Step 5: Exhausting the Gas

Require the fumigator to exhaust the gas at the completion of the exposure period. Record detector tube readings and the time interval from the aeration in the corresponding fields in “DETECTOR READINGS” on the PPQ Form 429A.

Removal of the fumigant is facilitated by using an outside blower to force fresh air through portable canvas, plastic, or similar ducts. Another method is to use compressed air hoses to force fresh air into the area. Require the fumigator to use suction type fans with portable ducts to evacuate gas from storerooms to outside, downwind areas away from crew areas, preferably on the offshore side of the ship. Ensure that the fumigator does **not** point the ducts upward, since dissipation onto the deck may occur. Use the ship’s aeration/ventilation equipment if possible. Make sure that use of ship’s equipment will **not** distribute the exhausted gas to other areas within the ship.

Aeration

The fumigator must:

- ◆ Arrange for the aeration to proceed once the treatment is completed.
- ◆ Consider the wind direction when pointing the exhaust duct, and face the duct outlet toward an open area away from people.
- ◆ Ensure that, during the first 10 minutes of aeration, no one is present within 200 feet downwind of the exhaust duct outlet.
- ◆ Determine aeration buffer zones in accordance with [Environmental Protection Agency \(EPA\) Methyl Bromide Commodity Fumigation Buffer Zone Lookup Tables](#).
- ◆ Ensure no one is present within the perimeter of the aeration buffer zone unless they are wearing SCBA.
- ◆ Refer to “Buffer Zone Overlap for Multiple Enclosures”.

- ◆ Follow all label instructions, state, county, and local regulations, in addition to the instructions in this manual.
- ◆ Inform people located in occupied structures and personnel in the immediate area within the buffer zone that release of MB is about to take place and give them the option of leaving the area or remaining inside the building.
- ◆ Restrict access to the area where the exhaust duct extends beyond the enclosure.

Wearing Respiratory Protection

The fumigator **must** wear approved respiratory protection (SCBA, supplied air respirator, or combination unit) when there is a risk of exposure to concentrations above 5 ppm; this includes any time the concentration is unknown.

MB 2016 Label

NOTICE

If MB concentration levels are between 1-4 ppm, the PPQ official and the fumigator may wear an air purifying respirator NIOSH certified half-mask or full face piece with a cartridge.

Aerating the Area

Advise the fumigator to:

1. Wearing the SCBA, open doors, hatches, tarpaulins, and areas to facilitate aeration.
2. Connect the exhaust system.
3. Start the exhaust system (minimum 3,500 cfm exhaust fan connected to an exhaust duct).
4. Aerate until gas concentrations are 5 ppm or less.
5. Stop the aeration fans.
6. While wearing SCBA, take a concentration reading with a colorimetric tube in the airspace within the fumigated area.

The PPQ official must record the date, concentration reading, and time on PPQ Form 429A. In the electronic 429 database, record the time, and detector reading (in ppm) in the corresponding fields on the “Detector Readings” form.

Chemical Treatments

Fumigants—Methyl Bromide—Structure Fumigation

Under Construction

The information in this chapter has been temporarily removed. For more information, contact USDA-APHIS-PPQ Field Operations at PPQ.Ops.Treatment@usda.gov.

Chemical Treatments

Fumigants—Methyl Bromide—Special Procedures for Container Fumigations Without a Tarpaulin

Contents

Introduction	2-8-1
2016 Methyl Bromide Label Information	2-8-1
Responsibilities	2-8-3
Methods and Procedures	2-8-4
Materials Needed	2-8-5
PPQ Officer Provides	2-8-5
Fumigator Provides	2-8-6
Preparing to Fumigate	2-8-7
Conducting the Fumigation	2-8-17
Aeration	2-8-25
Responsibility for Aerating the Commodity	2-8-26
Wearing Respiratory Protection	2-8-26

Introduction

APHIS allows the fumigation of a container WITHOUT a tarpaulin provided the containers are located outdoors and can be shown to be structurally sound. For cut flower, fresh fruit and vegetable treatments of 4 hours duration or less, APHIS may approve on a case-by-case basis the use of containers without the use of a tarpaulin. The commercial fumigator should contact the local PPQ office to initiate the process for container approval. Refer to [Table 2-8-1](#) for detailed responsibilities.

The integrity of these containers (ability to hold methyl bromide adequately) is predetermined by passing a pressure test. See [Container Prepping and Pre-Testing](#) on page 2-8-14.

2016 Methyl Bromide Label Information

In 2015, the Environmental Protection Agency (EPA) directed all methyl bromide (MB) registrants to amend the use directions on the labels of all 100% MB products. EPA required the changes in order to reflect recommendations in an EPA report.¹

These amendments modify the use directions for fumigation and aeration procedures, modify respiratory requirements and equipment and update gas monitoring equipment. EPA requires all labels on newly manufactured MB to reflect these recommendations effective **October 01, 2016**; however, EPA is allowing existing stocks of MB to be used in accordance with the use directions on the existing stock's (older) labels.

PPQ officials and fumigators **must** closely examine gas cylinder labels in order to validate that the dosage, exposure, and commodity are either on the cylinder label or covered by a FIFRA Section 18 exemption. If a label is **not** affixed to the cylinder, **DO NOT** allow the fumigator to use that cylinder.

New Buffer Zone Requirements

All 2016 MB labels now require both a treatment and an aeration buffer zone. Both the treatment and aeration buffer zones are specific to the enclosure being fumigated and must be determined by tables in the [Environmental Protection Agency \(EPA\) Methyl Bromide Commodity Fumigation Buffer Zone Lookup Tables](#). The fumigators are responsible for using this website to determine the buffer zones and reporting both buffer zones to the PPQ official. If the treatment buffer zone is determined to be less than 30 feet, the PPQ official will maintain PPQ's standard 30 foot treatment buffer zone; otherwise, the new treatment buffer zone **must** be observed. If the aeration buffer zone is determined to be less than 200 feet, then PPQ's standard "200 feet for 10 minutes" aeration buffer zone **still** applies for the first 10 minutes of aeration. The fumigator **must** refer to EPA's website to determine the minimum aeration buffer zone to be maintained until the aeration period is complete and the fumigator has verified that gas concentration levels meet the conditions in the MB label.

Transiting through buffer zones

The label permits vehicles to transit through both treatment and aeration buffer zones under specific conditions found in the label; it is up to the fumigator determine how or whether vehicles may transit in accordance with the label.

When using the newer 2016 MB label, changes to certain procedures and equipment in this chapter are displayed in a NOTICE box with a heading titled "MB 2016 Label".

1 "Report of Food Quality Protection Act (FQPA) Tolerance Reassessment and Risk Management Decision (TRED) for methyl bromide, and Reregistration Eligibility Decision (RED) for Methyl Bromide's Commodity Uses", archive dated August 2006.

MB 2016 Label (example)

NOTICE
Use this information when the fumigator is using the 2016 MB label.

When using existing stocks, follow the equipment and procedural guidance that is displayed in the **body** of the text (**outside** of the NOTICE box).

If there is no “MB 2016 Label” NOTICE box, then the instructions apply to all MB labels, 2016 and older.

Responsibilities

Refer to [Table 2-8-1](#) for the processes and responsible parties when approving a container for tarpless fumigation.

Table 2-8-1 Responsibilities for Approving Tarpless Container Fumigations

Action:	Responsible Party			
	Local PPQ Field Office	Field Operations Hub (FO-H)	QPAS	S&T-TMT
1. Receives request from fumigator about tarpless fumigation. Request includes fumigator contact information and details of fumigation location	X			
2. Local field office sends details of the inquiry to:		X		
3. FO-H sends details of the inquiry to:			X	X
4. Acknowledges receipt of request via email to the fumigator; sends requirements for pressure testing (see Container Prepping and Pre-Testing) and ensures that the requirements are understood		X	X (if non-routine)	X (if non-routine)
5. Fumigator submits proposed protocol to:		X		
6. Once protocol is agreed upon, fumigator is notified whether the protocol is approved or denied by:		X		
7. When fumigator is ready for on sight approval, dates for testing are scheduled by:		X		X (if non-routine)
8. On sight approval conducted, trip report, including recommendation, sent to S&T-TMT and QPAS by:		X	X (if non-routine)	
9. Concurrence reached over whether approval is granted		X	X	X
10. Notification of approval in writing sent by:		X		

Table 2-8-1 Responsibilities for Approving Tarpless Container Fumigations (continued)

Action:	Responsible Party			
	Local PPQ Field Office	Field Operations Hub (FO-H)	QPAS	S&T-TMT
11. Training of local PPQ officials (pressure testing) by:		X		
12. Follow up audits conducted if needed		X	X (if non-routine)	

Methods and Procedures

The procedures covered in this section provide PPQ officials and commercial fumigators with the methods, responsibilities, and precautions for container fumigation without a tarpaulin.

A refrigerated container may be used for fumigations without a tarpaulin provided the following requirements are met:

- ◆ Air exchange vents must be closed and taped if any openings are visible
- ◆ Air introduction and exhaust ducts installed
- ◆ Container must be a refrigerated sea container or refrigerated over-the-road freight trailer with metal flooring
- ◆ Container must have three gas monitoring leads in the front-high, middle-middle, and rear-low of the container (the “rear” is considered to be at the doors)
- ◆ Container must be packed (in some cases repacked) so that two circulation fans can be placed on top of the commodity; one in the front and one in the back
- ◆ Packing will ensure a minimum of 18 inches of air space above the commodity
- ◆ Rear fan (at the doors) has the gas introduction hose attached to it and is referred to as the gas introduction fan
- ◆ Use fans that have the capacity to move a volume of air in cubic feet per minute equivalent to the total volume of the container
- ◆ Container must have all drainage holes (corner drip holes) sealed
- ◆ Container must not have side doors or rear doors with damaged/missing gaskets
- ◆ Container must successfully complete the [Official Pressure Test](#) described in this chapter

- ◆ Container must have all refrigeration units turned off during pressure testing and when under fumigation

Materials Needed

PPQ Officer Provides

- ◆ Calculator (optional)
- ◆ PPQ Form 429B
- ◆ Self-contained breathing apparatus (SCBA) or supplied air respirator
- ◆ Stopwatch

MB 2016 Label

NOTICE

In addition to the bulleted equipment list required from PPQ, PPQ must also provide:

- ◆ Air purifying respirator NIOSH certified half-mask or full face piece with a cartridge for concentrations between 1 and 4 ppm
- ◆ APHIS-approved continuous real time gas monitoring device
 - ❖ Permanently mounted in PPQ owned facilities only, PureAire Monitoring Systems, Inc., model Air Check Advantage. The Air Check Advantage can be calibrated either by the manufacturer or by the PPQ official. Calibrate according to the manufacturer's User Guide. Refer to Chapter 8: Equipment for more information.
 - ❖ Portable Photoionization Detector (PID), RAE Systems, Inc. model MiniRAE 3000. The MiniRAE 3000 must be calibrated by the PPQ official according to the manufacturer's User Guide. Refer to Chapter 8: Equipment for more information.
- ◆ Self contained breathing apparatus (SCBA) NIOSH approval prefix TC-13F or supplied air respirator NIOSH approval prefix TC-19C

Fumigator Provides

- ◆ Aeration fans with ducts
- ◆ APHIS-approved methyl bromide monitor¹ (e.g. thermal conductivity device, infrared device, etc.)
- ◆ Auxiliary pump or Mighty Vac for purging long gas sampling lines
- ◆ Colorimetric tubes (see Appendix E for a list of APHIS-approved product ranges)
- ◆ Ducts (introduction and exhaust)
- ◆ Electrical wiring (grounded, permanent type), three-prong extension cords
- ◆ Fans (circulation and introduction)
- ◆ Gas introduction hose
- ◆ Gas sampling tubes
- ◆ Methyl bromide
- ◆ Pressure testing equipment
 - ❖ Any device or equipment with the ability to pressurize a container (for example, blowers, compressors, tanks, manifolds)
 - ❖ Manometer
 - ❖ Sealing putty
- ◆ Scales or dispensers²
- ◆ Self-contained breathing apparatus (SCBA) or supplied air respirator
- ◆ Tape
- ◆ Temperature recorder and temperature sensors³
- ◆ Thermometer⁴
- ◆ Volatilizer
- ◆ Warning signs/placarding

-
- 1 Methyl bromide monitor must be calibrated annually. See [Equipment](#) on page 8-1-1 for calibration information. If using a thermal conductivity (T/C) analyzer, Drierite® and Ascarite® must be used.
 - 2 All scales must be calibrated by the State, a company that is certified to conduct scale calibrations, or by a state-certified fumigator under the supervision of PPQ. The source and date of calibration must be posted in a visible location on or with the scale at all times. The scale must be calibrated a minimum of every year.
 - 3 Temperature sensors must be calibrated annually by the manufacturer or National Institute of Standards and Technology (NIST) within the range of 40 °F to 80 °F (4.4 °C to 26.7 °C).
 - 4 The thermometer must be calibrated or replaced annually.

MB 2016 Label

NOTICE

In addition to the bulleted equipment list required from the fumigator, the fumigator must also provide:

- ◆ Air purifying respirator NIOSH certified half-mask or full face piece with a cartridge for concentrations between 1 and 4 ppm
- ◆ APHIS-approved direct read gas detection device
 - ❖ Colorimetric tubes (e.g. Draeger, Sensidyne)
- ◆ APHIS-approved continuous real time gas monitoring device
 - ❖ Permanently mounted in PPQ owned facilities only, PureAire Monitoring Systems, Inc., model Air Check Advantage
 - ❖ Portable Photoionization Detector (PID), RAE Systems, Inc. model MiniRAE 3000
 - ❖ Devices **must** be calibrated according to the manufacturer's User Guide. Refer to Chapter 8: Equipment for more information.
- ◆ Self contained breathing apparatus (SCBA) NIOSH approval prefix TC-13F or supplied air respirator NIOSH approval prefix TC-19C

Preparing to Fumigate

Step 1: Selecting the Container

The fumigator **must** obtain a letter of authorization from the owner of the container, the shipping line, or the broker prior to attempting to gain access through the container doors or making any structural changes to the containers. The fumigator will maintain the letters of authorization and provide copies to the local PPQ office upon request. PPQ is **not** responsible for any damage incurred by the fumigator due to modification or manipulation of a container's original condition.

Step 2: Selecting the Fumigation Site

The PPQ official and the fumigator **must** consider the following factors when selecting a fumigation site:

- ◆ Aeration requirements
- ◆ Electrical power supply
- ◆ Nonwork area that can be effectively marked and safeguarded or isolated
- ◆ Water supply

- ◆ Well-lighted area
- ◆ Well-protected area
- ◆ Buffer Zone Overlap for Multiple Enclosures

Aeration Requirements

The fumigator **must** restrict access to the area where the exhaust duct extends beyond the container. Before a fumigation begins, the fumigator **must** ensure the exhaust duct is located in a safe place. During the first 10 minutes of aeration, the fumigator **must** not allow anyone within 200 feet downwind of the exhaust duct outlet. The fumigator is responsible for planning the fumigation so that aeration can be safely conducted immediately following the fumigation.

MB 2016 Label

NOTICE

The fumigator is responsible for all aspects of aeration. When the fumigation is a Section 18 exemption fumigation, the PPQ official is required to verify the final gas concentration reading(s). Refer to xx for more information.

Electrical Power Supply

Require the fumigator to supply an adequate electrical source to run the circulation fans and the gas detection unit. A separate line should be available for the gas detection unit. Electrical outlets must be grounded and conveniently located in relation to the fumigation area. PPQ does **not** allow the use of generators as a power source, except under emergency conditions.

Nonwork Area-MB 2016 Label

NOTICE

The fumigator will determine the treatment buffer zone in accordance with the [Environmental Protection Agency \(EPA\) Methyl Bromide Commodity Fumigation Buffer Zone Lookup Tables](#).

The treatment buffer zone surrounds the area where access is limited during treatment. If the fumigator determines that the buffer zone is less than 30', then PPQ requires a 30' buffer zone. If the fumigator determines that the buffer zone is greater than 30', then PPQ must observe the prescribed buffer zone.

The treatment buffer zone extends from the perimeter of the enclosure to a distance determined by the fumigator in accordance with the label. Entry by any person except the PPQ official and the fumigator is prohibited except as provided in the "Exceptions to Buffer Zone Entry Restrictions" section of the label.

The treatment buffer zone begins when the fumigant is introduced into the enclosure and ends when aeration begins, at which point the aeration buffer zone requirements apply.

The fumigator must define treatment and aeration buffer zone perimeters using physical barriers (such as walls, ropes, etc.) and placards to limit access to the buffer zone. Placards must meet all label requirements regarding specific warnings, information, and language.

The fumigator will permit transiting through buffer zones in accordance with the "Transit Exception" section of the label.

Buffer Zone Overlap for Multiple Enclosures

For multiple enclosures where buffer zones overlap, the fumigator must recalculate both the treatment and aeration buffer zones in accordance with the label and supply them to the PPQ official.

Nonwork Area

The PPQ official and the fumigator **must** select a secure area where traffic and people are restricted from entering and that is isolated from people working. A nonwork area is preferred to help prevent accidents such as a forklift piercing a container. The fumigation area is the area 30 feet surrounding the container(s) and is separated from the non-fumigation area by a physical barrier such as ropes, barricades, or walls.

Restrict access to the fumigation and aeration areas to the fumigator's employees and PPQ employees monitoring the treatment. The area outside the 30-foot perimeter is usually regarded as a safe distance from the fumigation.

The fumigator must placard within the perimeter of the secure area (including the entrance) with the appropriate DANGER/PELIGRO signs. Make sure the placards meet the appropriate fumigant label or labeling requirements. The skull and crossbones should be present as well as “AREA UNDER FUMIGATION, DO NOT ENTER/NO ENTRE”; date of the fumigation; name of the fumigant used; and the name, address, and telephone number of the fumigator. Unless you (PPQ) authorize their use, do not allow motorized vehicles to operate within 30 feet of the fumigation and aeration areas. The 30-foot perimeter is not specifically mentioned on the MB label, but is required for PPQ officials.

When multiple containers are being fumigated, there must be sufficient space for a person wearing SCBA to walk between the containers.

Water Supply

A water supply is necessary for safety purposes. Water is necessary for washing off MB if the liquid form is spilled on someone. If no permanent water is present on site, the fumigator must provide a five-gallon supply of potable, unfrozen water.

Well-Lighted Area

The fumigator will ensure that the area has adequate lighting for safety purposes and for ease in reading gas detection units, thermometers, and for determining whether a container has holes or places where the MB may leak.

Well-Ventilated, Sheltered Area

The PPQ official and the fumigator must select sites that well-ventilated and sheltered. A well-ventilated site is required for exhausting the gas. Avoid areas where strong drafts are likely to occur.

Ensure that the fumigator selects a site that is semi-sheltered, such as the leeward side of a warehouse or pier to offer some protection from severe winds. Severe winds are defined as sustained winds or gusts of 30 m.p.h. or higher for any time period. Do not allow the fumigation to proceed if there is a forecast from the National Weather Service of severe winds and/or thunderstorms at the beginning of or for the entire length of the fumigation.

NOTICE

Nontarped containerized fumigations **cannot** be conducted in a warehouse

Some gas will escape from the container even in the best conditions. The fumigator must ensure that the exhausted gas does not endanger people

working outdoors. When treatments are conducted in a particular location on a regular basis, a permanent site should be designated.

Step 3: Arranging the Containers

Ensure that the containers are not loaded beyond 80 percent of their capacity. There must be a space of a minimum of 18 inches above the commodity. This allows a crawl space for placing the gas sampling lines and fans, and facilitates uniform gas distribution. (Some restacking of cargo may be necessary to meet this requirement.) Require the commodity to be on pallets to allow adequate space (at least 2 inches) below the commodity.

APHIS does **not** allow stacking of containers. Stacking creates a safety risk to the person(s) installing fans, sampling lines, and aeration ducts.

Step 4: Arranging and Operating Fans

Require the fumigator to use a minimum of two 2,500 cfm fans for efficient gas circulation. Ensure that the fans are placed on top of the palletized commodity; one fan at the doors (rear) and one fan in the front. The rear fan is the gas introduction fan and should be pointed into the container. The front fan is pointing in the opposite direction.

NOTICE

Do **not** run the container's fan or refrigeration unit during the fumigation.

Step 5: Placing the Gas Introduction Line

MB is converted from a liquid into a gas by a volatilizer. The hose that runs from the MB cylinder into the volatilizer **must** be 3000 PSI hydraulic high pressure hose with a 3/8 inch inner diameter (ID) or larger. From the volatilizer, MB gas is introduced into the container by means of a gas introduction hose. The gas introduction line must be a minimum of 350 PSI with a 1/2 inch ID or larger. Ensure that the fumigator places the introduction line directly above the fan at the rear door of the container. Each container **must** have a gas introduction line.

Step 6: Placing the Gas Sampling Tubes

Ensure that the fumigator installs at least three gas sampling tubes per container. Insert the gas introduction line and sampling tubes between the closed rear door gaskets, or in some other location that does not interfere with successful pressure testing. Position the gas sampling tubes as follows:

- ◆ Front low — near the floor at the door end of the container
- ◆ Rear high — rear of the load at the high end opposite the fan
- ◆ Middle center — mid way from front to back, at mid depth

Require the fumigator to use gas sampling tubes of sufficient length to extend from the sampling position inside the container to at least 30 feet beyond the container. Ensure that all the gas sampling tubes meet in one area for ease and safety in taking gas concentration readings. Do **not** permit gas sampling tubes to be spliced. Before starting the fumigation, check for gas sampling tube blockage or pinching by connecting each tube to the gas detection device for a short time. If the line is blocked, the flow to the device will drop sharply. Tubes can also be checked with a MityVac[®] hand pump or other air pump device. Require the fumigator to replace any defective gas sampling tubes.

Step 7: Measuring the Temperature

The PPQ official must determine the temperature of the commodity in order to select the proper dosage rate. To take the temperature readings, use a calibrated bimetallic, mercury, or digital long-stem thermometer.

Depending on whether or not you are fumigating a pulpy fruit or vegetable, you may use either the commodity temperature or an average of the commodity and air temperatures. A pulpy fruit or vegetable can support internal feeding insects, is fleshy and moist, and can be probed with a temperature measuring device. Examples include, but are not limited to peppers, onions, and grapes.

For pulpy fruits and pulpy vegetables, insert the thermometer into the pulp and use the **only** the commodity temperature to determine the dosage rate. For commodities that have been refrigerated, probe the fruits that have the lowest pulp temperature. Again, fumigate only when the fruit pulp is at 40°F or higher.

If the commodity has **no** pulp (e.g., peas, beans, grains, herbs, spices, etc.), take the temperature of the air space immediately surrounding the commodity as well as the commodity temperature and use [Table 2-8-2](#) to determine the correct temperature to use when selecting the proper dosage rate.

NOTICE

Do **not** fumigate at temperatures below 40°F. The presence of ice indicates temperatures below 40°F. If ice is present anywhere in the box, pallet, or container, do **not** fumigate the commodity.

Table 2-8-2 Determine Whether to Use Commodity or Air Temperature for Determining Dosage Rate For Nonpulp Commodity

If the air temperature is:	And:	Then:
Higher than the commodity temperature		Use the single lowest commodity temperature for determining the dosage rate (DO NOT use the average commodity temperatures).
Lower than the commodity temperature	By less than 10 degrees	Use the average of the single lowest air and commodity temperatures for determining the dosage rate. (Never initiate a fumigation if any temperature reads lower than 40°F.)
	By 10 degrees or more	

Step 8: Measuring the Volume

Using a 100-foot tape measure, the PPQ official and the fumigator must carefully measure the length, width, and height of the container. Never estimate the measurements. An error in measurement of as little as 12 inches can result in miscalculating the dosage by as much as 15 percent. When measuring, round off to the nearest quarter foot (e.g., 2 1/4 inches = 0.25 feet). In the case of fumigations of edible commodities, an error can result in an unacceptable level of residue on the commodity.

Formula for determining volume:

length x width x height = volume in cubic feet

EXAMPLE A stack with measurements H=10'6", L=42'3", W=10'9"
 $10.50 \times 42.25 \times 10.75 = 4,768.9 \text{ ft}^3$ rounded to 4,769 ft^3

The PPQ official must record volume in Block 26 of PPQ Form 429B. In the electronic 429 database, record the length, width, and height in the corresponding fields under the "AMT of Gas Introduced" heading on the treatment form.

Step 9: Calculating the Dosage

The PPQ official must calculate dosage by doing the following:

1. Refer to the treatment schedule for the correct dosage rate (lbs/1,000 ft^3) based on temperature (°F).
2. Multiply by the dosage (lbs/1,000 ft^3) rate by the volume (ft^3) to get the dosage in pounds.
3. Round to the nearest quarter pound.

Formula for calculating dosage:

$$\text{Dosage (lbs.)} = \frac{\text{Volume (ft}^3\text{)} \times \text{Dosage Rate (lbs.)}}{1,000 \text{ ft}^3}$$

Figure 2-8-1 Formula for MB Calculating Dosage for Container Fumigations Without a Tarpaulin

The PPQ official must record dosage in Block 33 of PPQ Form 429B. In the electronic 429 database, the PPQ official must enter the dosage rate in the “dosage” field and the total amount of gas required for the fumigation will be displayed in the “Gas Required” field.

Step 10: Container Pressure Testing

In order to ensure that the container can maintain the required gas concentrations, it **must** be pressure tested. Sea containers or over-the-road freight trailers may be considered for pressure testing and tarpless fumigation if they possess solid metal walls and ceilings, a channeled solid metal floor, and were originally manufactured with two rear doors. Side doors are **not** permitted.

Any process for pressure testing or tarpless container fumigation which requires modification or a structural change to the container will require a letter of authorization from the owner. The fumigator shall maintain the letters of authorization and provide copies to the local PPQ office upon request. The container owners **must** agree to repair any container with modified drain holes before they are used for tarpless fumigation.

Required Equipment

The fumigator **must** supply the following equipment for the pressure test:

- ◆ Any device or equipment with the ability to pressurize a container (for example, blowers, compressors, tanks, manifolds)
- ◆ A manometer for recording the internal container pressure during the test. The units may be either Pascals (Pa) or inches of water, and **must** be able to reach a minimum of 250 Pa or 1.0 inch of water.
- ◆ Sealing putty for plugging around drain holes, gaps between door gaskets, and sealing around pressure insertion hose.

Container Prepping and Pre-Testing

In preparation for the pressure test, the fumigator **must**:

1. Close vents and turn off refrigeration unit

2. Seal corner drain holes
3. Repair any visible damage to the container or any parts potentially impacting air tightness
4. Attach a pressurization and monitoring apparatus to the container
5. Pressurize the container to a minimum pressure of 250 Pa (1.0 inch of water)
6. Monitor the pressure to ensure that the decrease from 200 Pa to 100 Pa (0.8 inches to 0.4 inches) takes at least 15 seconds
7. Identify and repair leaks

After the fumigator has conducted a successful pressure test, PPQ will observe and record the official time for the final pressure test.

Official Pressure Test

The PPQ official will:

1. Observe the fumigator pressurizing the container to 250 Pa (1.0 inches).
2. Allow the pressure to decrease to 200 Pa and then record the time it takes to decrease from 200 Pa to 100 Pa (0.8 inches to 0.4 inches) with a stopwatch.

A successful (passing) test is defined by a minimum of 15 seconds transpiring while pressure decreases from 200 Pa to 100 Pa (0.8 inches to 0.4 inches). The PPQ official should confirm a passing test before permitting the fumigator to proceed with a tarpless fumigation. Record the passing test time on PPQ Form 429B, and enter it into the electronic 429 database. This data field is in the “Treatment” tab of the fumigation report in the “Setup” section. If “Approved Tarpless Container” is selected as the “Enclosure” type, then two additional fields appear in the report, “Was the pressure test conducted?” and “Pressure Test Time (seconds).” Record the time it takes the pressure to drop from 200 to 100 Pa and enter the time (in seconds) into the fumigation report. Officials are not to stop timing after the time exceeds 15 seconds; continue timing until the pressure reaches 100 Pa or 90 seconds have elapsed. If the latter occurs, record “90” seconds as pressure loss interval.

If the container fails the pressure test (as defined by not holding pressure for a minimum of 15 seconds), record the time lapse in “REMARKS” in PPQ Form 429B and in the electronic 429 database. Tarp the container and fumigate according to this manual, Chapter 2-4-Chemical Treatments, Fumigants, Methyl Bromide, Tarpaulin Fumigation.

Ensure that the fumigator places three gas sampling tubes within the container as described in [Placing the Gas Sampling Tubes](#). Ensure the placement of the

lines where they exit the container so the integrity of the sealed container is maintained. For example, an acceptable location for sampling tubes is along the sill of the container below the left door, pressed onto a small snake of plumbers putty to make a good seal with the sill and door gasket.

Step 11: Making a Final Check

Before introducing the gas, the PPQ official and the fumigator **must** ensure that the following activities are performed:

- ◆ Turn on all circulation fans and APHIS-approved methyl bromide gas detection monitors to make sure they work.
- ◆ Warm up and zero (if required) the APHIS-approved methyl bromide gas detection monitor as described in the [Equipment](#) chapter of this manual.
- ◆ Start volatilizer and heat water to 200°F or above (*See Volatilizer* on page [8-1-14](#) for temperature monitoring procedures.) A minimum temperature of 150°F is required at all times during the introduction process.
- ◆ Place fumigant cylinder with gas introduction hose on scale and take initial weight reading.
- ◆ Ensure the gas introduction hose is attached to the cylinder.
- ◆ After obtaining the correct weight, subtract the dosage to be introduced into the container.
- ◆ After introducing the proper amount of gas, the scale will be balanced.
- ◆ Ensure the container is placarded and the area is secured; only people working on the fumigation can be in the area.
- ◆ Ensure that any vents or holes in the container are sealed.
- ◆ Ensure all gas sampling tubes are labeled and are not crimped or crushed.
- ❖ Visually inspect lines or use an electric or Mityvac[®] hand pump to check for blockage.

When conducting fumigations, erroneous readings can occur if the sampling lines become blocked or crimped. It would be impossible to install a new sampling line during a fumigation treatment. Therefore, to avoid an unsuccessful fumigation, test sampling lines before the treatment begins.

Refer to the following steps to detect blocked sampling tubes with the use of a MityVac® hand-held pump (for supplier, see Appendix E.)

1. Prior to gas introduction, connect a MityVac® hand-held vacuum pump to sampling tubes.
2. Squeeze the handle on the MityVac® unit. If the line is blocked, a vacuum will be indicated on the MityVac® gauge. For sampling tubes longer than 25 feet, squeeze the handle two or three times. The MityVac® pump has the capacity to attain and hold 25 inches of Hg vacuum and a minimum of 7 psig pressure.
3. Disconnect the MityVac® pump from the sampling tube and repeat this procedure for each sampling tube. (Connect sampling tubes to the gas analyzer prior to fumigant introduction.)

- ◆ Confirm that there is enough gas in the cylinder and if necessary, that other cylinders are available.
- ◆ Ensure that all safety equipment, especially SCBA, is available and in working order.
- ◆ Confirm that the gas introduction line connections are tight and free of leaks.
- ◆ If using a T/C monitor, install Drierite® and Ascarite® filters as stated in the instructions in this manual.

Conducting the Fumigation

Step 1: Introducing the Gas

CAUTION

The PPQ official must wear SCBA anytime the air concentration is unknown or greater than or equal to 5 ppm.

MB 2016 Label

NOTICE

If MB concentration levels are between 1-4 ppm, the PPQ official and the fumigator may wear an air purifying respirator NIOSH certified half-mask or full face piece with a cartridge.

Require the fumigator to use SCBA while introducing and adding gas. The PPQ official is not required to be in the treatment buffer zone during the fumigation. The PPQ official must ensure that the fumigator turns on all

circulation fans before introducing the gas. When using large cylinders of MB, the fumigator should slightly open the cylinder valve, then close the valve.

 **DANGER**

If the PPQ official or fumigator notices a cloud, plume, vapor, or mist coming from the introduction equipment during gas introduction, the fumigator must **TURN OFF** the valve on the gas cylinder, **EVACUATE** the area immediately, and **ABORT** the fumigation.

No person should place any part of their body into the cloud, plume, vapor, or mist. After the cloud plume has dissipated, measure gas concentration levels at the gas cylinder using any APHIS-approved continuous real time gas detection device.

When gas concentration levels at the cylinder reach 5 ppm or less, the fumigator must identify the source of the leak and correct it before restarting the fumigation.

Any person within the treatment buffer zone must wear and use SCBA equipment during gas introduction and gas addition.

With an APHIS-approved continuous real time gas detection device, the fumigator must check all connections on the gas introduction line (between the MB cylinder and the volatilizer) for leaks. If leaks are found, advise the fumigator to tighten the connections and repeat the test. If no leaks are found, require the fumigator to open the valve to the point where three to four pounds of MB are introduced per minute.

The water temperature in the volatilizer should never go below 150°F at any time during gas introduction. The water in the volatilizer can include an antifreeze and should be handled with the appropriate safeguards. *See Volatilizer* on page 8-1-14 for temperature monitoring procedures.

 **CAUTION**

Do not touch the introduction line with your bare hands — you could get burned! Close the cylinder valve once the proper dosage has been introduced.

The fumigation time begins once all the gas has been introduced. The PPQ official **must** record the time gas introduction was started and completed in Block 32 on PPQ Form 429B. In the electronic 429 database, record the fumigation date, gas introduction start and finish time in the corresponding fields under the “GAS INTRODUCTION” heading in the Treatment form.

Require the fumigator to run the fans for 30 minutes to achieve even gas distribution. The PPQ official **must** take the initial concentration reading 30 minutes after all the gas has been introduced.

When evacuating large cylinders, getting the final amount of gas out may take a long time. Consider taking a gas concentration reading 30 minutes after the gas was first introduced. If the gas distribution is even (all readings within 4

ounces of each other) and at a significantly high concentration, advise the fumigator to turn off the fans. Running the fans longer can contribute to gas leakage. Allow the remainder of the gas to discharge while intermittently running the fans. Normally, all the gas should be introduced within 30 minutes.

NOTICE

Do not begin counting fumigation time until all the gas has been introduced and the valve on the MB tank is closed.

If the fumigator detects excessive leakage (concentration readings of 50 percent or less of the minimum concentration), do **not** attempt to correct the problem by adding more gas. Aerate the container and return, re-export, or destroy the commodity. Commodities used for food or feed **cannot** be retreated.

Step 2: Taking Concentration Readings

The PPQ official **must** take concentration readings 30 minutes after gas introduction. Use an APHIS-approved gas detection device to determine the gas concentration and distribution within the container. Allow gas concentration readings to stabilize; do **not** disconnect the sampling line from the gas detection device when the minimum concentration reading has been met.

NOTICE

Before taking a reading, always purge sampling lines with a mechanical or hand pump. If using a T/C unit, connect it to the sampling line, adjust the gas flow rate to 1.0, and wait until the meter registering “ounces per thousand cubic feet” stabilizes before taking a reading. (This may take a minute or more, depending upon the length of the tubing and whether or not an auxiliary pump is used.)

Take concentration readings at the times designated in the treatment schedule. Concentration readings should not differ more than 4 ounces among the lines. When concentration readings differ more than 4 ounces, run the fans to equalize the gas and record readings in the Remarks block on the PPQ Form 429B. In some case, several cycles of fan operation may be necessary to

equalize the readings. The PPQ official **must** record all gas readings on the PPQ Form 429B and in the electronic 429 database.

NOTICE

Avoid using hand-held, two-way radios near a T/C unit. Using two-way radios near a T/C unit will interfere with accurate concentration readings.

Step 3: Determining the Need to Add Gas and Adjust Exposure

Use [Table 2-8-3](#) to determine when to add gas or extend the exposure.

Table 2-8-3 Determine the Need to Add Gas and Adjust Exposure

If the lowest gas reading is:	And the schedule is:	Then:
Below the required minimum concentration	T101-a-1 or equivalent ^a	SEE Table 2-8-5 for corrections at 0.5 hours, or Table 2-8-6 for corrections at 2 hours
	Other than T101-a-1 or equivalent ¹	See Adding Gas and Extending Exposure to Commodities that are Fumigated Using Treatment Schedules Other Than T101-a-1 or Equivalent (may include perishables) on page 2-8-21
At or above the required minimum concentration	T101-a-1 or equivalent ¹	SEE Table 2-8-5 for corrections at 0.5 hours, or Table 2-8-6 for corrections at 2 hours
	Other than T101-a-1 or equivalent ¹	NO ACTION necessary

a T101-a-1 or equivalent schedules are those schedules that are:

- ◆ NOT greater than 2 hours long (exposure time)
- ◆ NOT greater than 4 lbs. per 1000 ft³ (dosage rate)
- ◆ Minimum concentration readings and temperature ranges match EXACTLY the readings in T101-a-1

If the minimum concentration readings do not meet these requirements, the schedule is **NOT** equivalent. When schedules are **NOT** equivalent, use [Table 2-8-4](#) to determine the length of time to extend exposure and use the formula in [Figure 2-8-2](#) on page 2-21 to determine the amount of gas to add.

Adding Gas and Extending Exposure to Commodities that are Fumigated Using Treatment Schedules Other Than T101-a-1 or Equivalent (may include perishables)

Once you have determined that you need to add gas and extend time, use the formula in [Figure 2-8-2](#) to calculate the amount of gas to add and [Table 2-8-4](#) to determine how long to extend the exposure period.

$$1.6 \times \text{number of ounces below minimum} \times \frac{\text{volume in cubic feet}}{1000 \text{ cubic feet}} \times \frac{1}{16} = \text{pounds of gas to add}$$

Figure 2-8-2 Formula for Determining the Amount of Gas to Add for Schedules Not T101-a-1 Equivalent and Conducted in a Container Without a Tarpaulin

Table 2-8-4 Determine the Extended Exposure Period to Commodities that are Not T101-a-1 Equivalent

And any individual reading is below minimum by:	Then extend exposure:
10 oz. or less	10 percent of the time lapse since gas introduction or the last acceptable reading
11 oz. or more	30 minutes

Adding Gas

When adding gas, require the fumigator to follow these steps:

1. Heat water in volatilizer.
2. Turn on fans.
3. Weigh the cylinder.
4. With SCBA on, open valve on cylinder and introduce the gas.
5. Close valve when the weight of the cylinder indicates that the needed amount of gas has been added.

The PPQ official **must** record quantity of fumigant added in Block 34 and additional fan time in Block 30 of PPQ Form 429B.

In the electronic 429, record the amount of additional gas listed in the Treatment Manual in the added in the “Additional Gas Recommended” field and the actual amount of additional gas added in the “Actual Additional Gas” field. Record the additional fan time in the “TIME FANS OPERATED” field in the Treatment form.

Note the time the fumigator started and finished introducing additional gas and record in Block 40 (Remarks) of PPQ Form 429B and in the “Remarks” form in the electronic 429 database. Require the fumigator to run the fans until there is even gas distribution throughout the stack. Turn off fans, then take a concentration reading 30 minutes after the gas has been introduced. If all readings are above minimum concentration levels, proceed as usual with the remaining scheduled concentration readings.

Adding Gas to Fruits, Vegetables, or Perishable Commodities Using Schedules T101-a-1 or Equivalent

Use [Table 2-8-5](#) and [Table 2-8-6](#) to determine if you need to add gas or extend or decrease the exposure time. Select the proper table based on the time of the gas reading (30 minutes or 2 hours). Use the formula in [Figure 2-8-3](#) to determine the amount of gas to add.

$$1.6 \times \text{number of ounces below minimum} \times \frac{\text{volume in cubic feet}}{1000 \text{ cubic feet}} \times \frac{1}{16} = \text{pounds of gas to add}$$

Figure 2-8-3 Formula for Determining the Amount of Gas to Add For T101-a-1 Equivalent Schedules for Container Fumigations Without a Tarpaulin

NOTICE

DO **NOT** average the concentration readings before using the tables. Base your decision on whether to add gas from the **LOWEST** gas concentration of any individual gas reading.

NOTICE

Fresh fruits and vegetables are sensitive to MB so you should double check volume calculations and dosage measurements to avoid accidental overdoses.

Adding Gas

When adding gas, require the fumigator to follow these steps:

1. Heat water in volatilizer.
2. Turn on fans.
3. Weigh the cylinder.
4. With SCBA on, open valve on cylinder and introduce the gas.

5. Close valve when the weight of the cylinder indicates that the needed amount of gas has been added.

The PPQ official must record quantity of fumigant added in Block 34 and additional fan time in Block 30 of PPQ Form 429B.

In the electronic 429, record the amount of additional gas listed in the Treatment Manual in the added in the “Additional Gas Recommended” field and the actual amount of additional gas added in the “Actual Additional Gas” field. Record the additional fan time in the “TIME FANS OPERATED” field in the Treatment form.

Note the time the fumigator started and finished introducing additional gas and record in Block 40 (Remarks) of PPQ Form 429B and in the “Remarks” form in the electronic 429 database. Require the fumigator to run the fans until there is even gas distribution throughout the stack. Turn off fans, then take a concentration reading 30 minutes after the gas has been introduced. If all readings are above minimum concentration levels, proceed as usual with the remaining scheduled concentration readings.

Table 2-8-5 Determine Gas Concentration Values and Corrections for Fruits and Vegetables at the 30-Minute Reading

If the schedule is:	And the minimum concentration (oz.) in the schedule is:	And the lowest concentration reading (oz.) is:	Then:
40-49 °F 4 lbs. for 2 hrs.	48	65 or greater	REDUCE exposure by 15 minutes
		64-48	TAKE 2 hour reading as scheduled
		Lower than 48	1. ADD gas, and 2. EXTEND exposure by 15 minutes
50-59 °F 3 lbs. for 2 hrs.	38	52 or greater	REDUCE exposure by 15 minutes
		51-38	TAKE 2 hour reading as scheduled
		Lower than 38	1. ADD gas, and 2. EXTEND exposure by 15 minutes
60-69 °F 2.5 lbs. for 2 hrs.	32	48 or greater	REDUCE exposure by 15 minutes
		47-32	TAKE 2 hour reading as scheduled
		Lower than 32	1. ADD gas, and 2. EXTEND exposure by 15 minutes
70-79 °F 2.0 lbs. for 2 hrs.	26	37 or greater	REDUCE exposure by 15 minutes
		36-26	TAKE 2 hour reading as scheduled
		Lower than 26	1. ADD gas, and 2. EXTEND exposure by 15 minutes
80-89 °F 1.5 lbs. for 2 hrs.	19	27 or greater	REDUCE exposure by 15 minutes
		26-19	TAKE 2 hour reading as scheduled
		Lower than 19	1. ADD gas, and 2. EXTEND exposure by 15 minutes

Table 2-8-6 Determine Gas Concentration Values and Corrections for Fruits and Vegetables at the 2-Hour Reading

If the schedule is:	And the lowest concentration reading (oz.) at 2 hours is:	Then DO NOT add gas, but:
40-49 °F 4 lbs. for 2 hrs.	38 and above	AERATE the commodity
	37-28	EXTEND exposure by 15 minutes
	27-25	EXTEND exposure by 30 minutes
	Lower than 25	ABORT
50-59 °F 3 lbs. for 2 hrs.	29 and above	AERATE the commodity
	28-24	EXTEND exposure by 15 minutes
	23-21	EXTEND exposure by 30 minutes
	Lower than 21	ABORT
60-69 °F 2.5 lbs. for 2 hrs.	24 and above	AERATE the commodity
	23-21	EXTEND exposure by 15 minutes
	20-18	EXTEND exposure by 30 minutes
	Lower than 18	ABORT
70-79 °F 2.0 lbs. for 2 hrs.	19 and above	AERATE the commodity
	18-16	EXTEND exposure by 15 minutes
	15-13	EXTEND exposure by 30 minutes
	Lower than 13	ABORT
80-89 °F 1.5 lbs. for 2 hrs.	14 and above	AERATE the commodity
	13-12	EXTEND exposure by 15 minutes
	11-10	EXTEND exposure by 30 minutes
	Lower than 10	ABORT

Step 4: Exhausting the Gas

Require the fumigator to exhaust the gas at the completion of the exposure period. If the treatment schedule is a FIFRA Section 18 Exemption, then the PPQ official **must** verify the final gas concentration reading of the commodity. Detector tube readings and the time interval from the aeration **must** be recorded in the corresponding fields in the “DETECTOR READINGS” form.

Aeration

The fumigator must:

- ◆ Arrange for the aeration to proceed once the treatment is completed.
- ◆ Consider the wind direction when pointing the exhaust duct, and face the duct outlet toward an open area away from people.

- ◆ Ensure that, during the first 10 minutes of aeration, no one is present within 200 feet downwind of the exhaust duct outlet.
- ◆ Determine aeration buffer zones in accordance with [Environmental Protection Agency \(EPA\) Methyl Bromide Commodity Fumigation Buffer Zone Lookup Tables](#).
- ◆ Ensure no one is present within the perimeter of the aeration buffer zone unless they are wearing SCBA.
- ◆ Refer to “Buffer Zone Overlap for Multiple Enclosures”.
- ◆ Follow all label instructions, state, county, and local regulations, in addition to the instructions in this manual.
- ◆ Inform people located in occupied structures and personnel in the immediate area within the buffer zone that release of MB is about to take place and give them the option of leaving the area or remaining inside the building.
- ◆ Restrict access to the area where the exhaust duct extends beyond the enclosure.

Responsibility for Aerating the Commodity

The label requires that at least two people trained in the use of the fumigant **must** be present at all times during gas introduction, treatment, and aeration. The PPQ official, however, is **not** required to be continuously present at the fumigation site throughout the aeration process unless specified by the label or by State or local regulations.

Refer to [Table 2-8-7](#) to determine who is responsible for aerating the commodity.

Table 2-8-7 Determine Responsibility for Aerating the Commodity for Tarpless Container Fumigation

If the Treatment schedule is:	Then:
A FIFRA Section 18 Exemption	PPQ official must be present at the initiation of aeration and to VERIFY the final aeration readings.
A labeled treatment schedule	RELEASE the fumigation to the fumigator to aerate and RELEASE the commodity.

Wearing Respiratory Protection

The fumigator **must** wear approved respiratory protection (SCBA, supplied air respirator, or a combination unit) when:

- ◆ A risk of exposure to concentrations above 5 ppm exists; this includes anytime the concentration is unknown
- ◆ Opening the container for aeration

- ◆ Setting up the air introduction and exhaust systems

MB 2016 Label

NOTICE

If MB concentration levels are between 1-4 ppm, the PPQ official and the fumigator may wear an air purifying respirator NIOSH certified half-mask or full face piece with a cartridge.

Step 1: Installing the Exhaust System

Advise the fumigator to:

1. Install an exhaust fan (minimum of 5,200 cfm capacity) with one end of a round ventilation duct at least 16 inches in diameter, oriented so that the fan pulls air through the duct. The fan dimensions should complement the diameter of ductwork chosen, fitting flush and tight so that no leaks exist between the fan and duct. The exhaust duct will be at least 30 feet in length with the fan end placed external and alongside the container extending toward the nose, so the exhaust air is directed away from the end of the container which is opened during aeration.
2. Install a fresh air introduction fan (minimum 3,750 cfm) with a round ventilation duct at least 12 inches in diameter, oriented so that the fan pushes the air through the duct. The fan dimensions should complement the diameter of ductwork chosen, fitting flush and tight so that no leaks exist between the fan and duct. Extend the introduction duct (non-fan end) along top of the load two-thirds of the length of the container.

SAFETY

Install air introduction and exhaust ducts prior to fumigation in order to limit human exposure to the fumigant at the start of aeration.

Palletized Partial Loads

For palletized partial loads (where at least 2 feet of open space is present at the door end of the container), ensure that the fumigator extends the exhaust duct intake (non-fan end) on the container floor with the duct face flush against the bottom of the load along a side of the container. Store the remaining section of the exhaust duct and fan at the rear of the load so it is easily accessible at the start of aeration.

Full Loads

For full loads (where less than 2 feet of open space is available at the door end of the container and there is no central aisle between pallets), if there is room to store the duct inside the container during fumigation, ensure that the fumigator secures the duct (non-fan end) face flush against the load at the floor/pallet/commodity interface along a side of the container so it will not shift or twist during aeration. Use straps, ties, or other fasteners to secure this interface tightly. If there is not sufficient room to pre-install the duct prior to fumigation, the fumigator can carry out these steps at the start of aeration.

For partial or full loads where a central aisle exists between the pallets, ensure that the fumigator places the duct along the floor center and extend 1-2 feet into this space if possible.

Refer to [Figure 2-8-4](#) for detailed diagrams of air and exhaust ducts. In this diagram, air introduction ducts are blue and exhaust ducts are red.

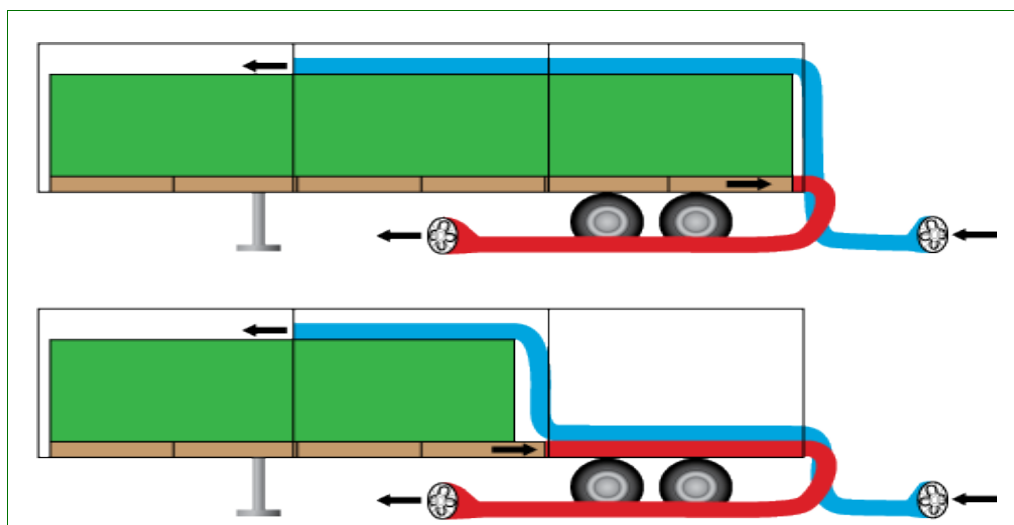

Figure 2-8-4 Ductwork configuration for aeration of untarped containers: full loads (top) and partial loads (bottom)

Step 2: Aerating the Commodity

Advise the fumigator to:

1. While wearing SCBA, open the doors of each container.
2. Turn on all fumigant circulation fans inside the container and leave them on throughout the aeration.
3. Start the container introduction and exhaust duct fans.
4. Require a minimum of 4 hours aeration for all sorptive commodities.
5. Stop the fans and take concentration readings with colorimetric tubes in the airspace around and, when feasible, within the commodity.

6. RELEASE the commodity when the concentration reading is 5 ppm or less.

Chemical Treatments

Fumigants—Methyl Bromide—Closed-door Container Fumigation

Contents

Methods and Procedures	2-9-1
2016 Methyl Bromide Label Information	2-9-1
Materials Needed	2-9-3
Preparing to Fumigate	2-9-5
Conducting the Fumigation	2-9-17
Aeration	2-9-21

Methods and Procedures

The procedures covered in this section provide PPQ officials and commercial fumigators with the methods, responsibilities, and precautions for closed-door container fumigations.

2016 Methyl Bromide Label Information

In 2015, the Environmental Protection Agency (EPA) directed all methyl bromide (MB) registrants to amend the use directions on the labels of all 100% MB products. EPA required the changes in order to reflect recommendations in an EPA report.¹

These amendments modify the use directions for fumigation and aeration procedures, modify respiratory requirements and equipment and update gas monitoring equipment. EPA requires all labels on newly manufactured MB to reflect these recommendations effective **October 01, 2016**; however, EPA is allowing existing stocks of MB to be used in accordance with the use directions on the existing stock's (older) labels.

PPQ officials and fumigators **must** closely examine gas cylinder labels in order to validate that the dosage, exposure, and commodity are either on the cylinder label or covered by a FIFRA Section 18 exemption. If a label is **not** affixed to the cylinder, **DO NOT** allow the fumigator to use that cylinder.

¹ "Report of Food Quality Protection Act (FQPA) Tolerance Reassessment and Risk Management Decision (TRED) for methyl bromide, and Reregistration Eligibility Decision (RED) for Methyl Bromide's Commodity Uses", archive dated August 2006.

New Buffer Zone Requirements

All 2016 MB labels now require both a treatment and an aeration buffer zone. Both the treatment and aeration buffer zones are specific to the enclosure being fumigated and must be determined by tables in the [Environmental Protection Agency \(EPA\) Methyl Bromide Commodity Fumigation Buffer Zone Lookup Tables](#). The fumigators are responsible for using this website to determine the buffer zones and reporting both buffer zones to the PPQ official. If the treatment buffer zone is determined to be less than 30 feet, the PPQ official will maintain PPQ’s standard 30 foot treatment buffer zone; otherwise, the new treatment buffer zone **must** be observed. If the aeration buffer zone is determined to be less than 200 feet, then PPQ’s standard “200 feet for 10 minutes” aeration buffer zone **still** applies for the first 10 minutes of aeration. The fumigator **must** refer to EPA’s website to determine the minimum aeration buffer zone to be maintained until the aeration period is complete and the fumigator has verified that gas concentration levels meet the conditions in the MB label.

Transiting through buffer zones

The label permits vehicles to transit through both treatment and aeration buffer zones under specific conditions found in the label; it is up to the fumigator determine how or whether vehicles may transit in accordance with the label.

When using the newer 2016 MB label, changes to certain procedures and equipment in this chapter are displayed in a NOTICE box with a heading titled “MB 2016 Label”.

MB 2016 Label (example)

NOTICE

Use this information when the fumigator is using the 2016 MB label.

When using existing stocks, follow the equipment and procedural guidance that is displayed in the **body** of the text (**outside** of the NOTICE box).

If there is no “MB 2016 Label” NOTICE box, then the instructions apply to all MB labels, 2016 and older.

Materials Needed

PPQ Official Provides

- ◆ APHIS-approved leak detection device
- ◆ Calculator (optional)
- ◆ Forms (PPQ Form 429A and APHIS Form 2061, if necessary)
- ◆ Self-contained breathing apparatus (SCBA) or supplied air respirator

MB 2016 Label

NOTICE

In addition to the bulleted equipment list required from PPQ, PPQ must also provide:

- ◆ Air purifying respirator NIOSH certified half-mask or full face piece with a cartridge for concentrations between 1 and 4 ppm
- ◆ APHIS-approved continuous real time gas monitoring device
 - ❖ Permanently mounted in PPQ owned facilities only, PureAire Monitoring Systems, Inc., model Air Check Advantage. The Air Check Advantage can be calibrated either by the manufacturer or by the PPQ official. Calibrate according to the manufacturer's User Guide. Refer to Chapter 8: Equipment for more information.
 - ❖ Portable Photoionization Detector (PID), RAE Systems, Inc. model MiniRAE 3000. The MiniRAE 3000 must be calibrated by the PPQ official according to the manufacturer's User Guide. Refer to Chapter 8: Equipment for more information.
- ◆ Self contained breathing apparatus (SCBA) NIOSH approval prefix TC-13F or supplied air respirator NIOSH approval prefix TC-19C

Fumigator Provides

- ◆ APHIS-approved gas detection device² (e.g. thermal conductivity device, infrared device, etc.)
- ◆ Auxiliary pump for purging long gas sample tubes
- ◆ Carbon dioxide filter (Ascarite[®])

² The methyl bromide monitor must be calibrated annually. Refer to Chapter 8: Equipment for calibration information. If using a thermal conductivity (TC) analyzer, Drierite[®] and Ascarite[®] must be used.

- ◆ Colorimetric tubes (Refer to *Gas Detector Tube (Colorimetric) and Apparatus* on page E-1-20 for a list of APHIS-approved product ranges)
- ◆ Desiccant (Drierite[®])
- ◆ Electrical wiring (grounded, permanent type), three prong extension cords
- ◆ Exhaust blower and ducts
- ◆ Fans (circulation, exhaust, and introduction)
- ◆ Framework and supports
- ◆ Gas introduction line
- ◆ Gas sampling tubes (leads)
- ◆ Heat supply
- ◆ Insecticides and spray equipment
- ◆ Loose sand
- ◆ Measuring tape
- ◆ Methyl bromide
- ◆ Padding
- ◆ Sand or water snakes or adhesive sealer
- ◆ Scales or dispensers³
- ◆ Self-contained breathing apparatus (SCBA) or supplied air respirator
- ◆ Tape
- ◆ Tape measure
- ◆ Tarpaulin and supports
- ◆ Temperature recorder
- ◆ Temperature sensors⁴
- ◆ Thermometer⁵
- ◆ Volatilizer
- ◆ Warning signs/placarding

3 All scales **must** be calibrated by the State, a company that is certified to conduct scale calibrations, or by the fumigator under the supervision of PPQ. The source and date of calibration **must** be posted in a visible location on or with the scale at all times. The scale **must** be calibrated a minimum of every 6 months.

4 Temperature sensors **must** be calibrated annually by the manufacturer or National Institute of Standards and Technology (NIST) within the range of 40 °F to 80 °F (4.4 °C to 26.7 °C).

5 The thermometer **must** be calibrated or replaced annually.

MB 2016 Label

NOTICE

In addition to the bulleted equipment list required from the fumigator, the fumigator must also provide:

- ◆ Air purifying respirator NIOSH certified half-mask or full face piece with a cartridge for concentrations between 1 and 4 ppm
- ◆ APHIS-approved direct read gas detection device
 - ❖ Colorimetric tubes (e.g. Draeger, Sensidyne)
- ◆ APHIS-approved continuous real time gas monitoring device
 - ❖ Permanently mounted in PPQ owned facilities only, PureAire Monitoring Systems, Inc., model Air Check Advantage
 - ❖ Portable Photoionization Detector (PID), RAE Systems, Inc. model MiniRAE 3000
 - ❖ Devices **must** be calibrated according to the manufacturer’s User Guide. Refer to Chapter 8: Equipment for more information.
- ◆ Self contained breathing apparatus (SCBA) NIOSH approval prefix TC-13F or supplied air respirator NIOSH approval prefix TC-19C

Preparing to Fumigate

APHIS has historically required dry box ocean containers (non-refrigerated containers with a tongue-and-groove flooring) be fumigated under tarp with the doors open. The total methyl bromide gas introduced is based on the entire volume under the tarpaulin. This is referred to as “open-door container fumigation.” As an alternative to the “open-door” procedure, APHIS also allows for the fumigation of wood products (includes logs, lumber, and bamboo) in dry box containers with the doors closed. This procedure eliminates the need to include the empty space under the container as part of the total volume fumigated. This procedure is referred to as “closed-door container fumigation” and can be used **only** with the following treatment schedules:

- ◆ T312-a
- ◆ T312-a-Alternative
- ◆ T312-b
- ◆ T404-b-1-1
- ◆ T404-d

◆ T404-e-1

Step 1: Selecting the Container

The fumigator **must** obtain a letter of authorization from the owner of the container, the shipping line, or the broker prior to attempting to gain access through the container doors or making any structural changes to the containers. The fumigator will maintain the letters of authorization and provide copies to the local PPQ office. PPQ will **not** be held responsible for any damage incurred by the fumigator due to modification or manipulation of a container's original condition.

No dry box container will be permitted to be fumigated using this procedure if it has side doors, if the rear gasket is missing, or if the gasket is damaged such that gas lines **cannot** be placed effectively with the doors closed. PPQ officials **must** ensure that all vents are sealed on each container to be fumigated. If this **cannot** be accomplished, the fumigator will be required to fumigate with the doors open.

Step 2: Selecting a Fumigation Site

The PPQ official and the fumigator must consider the following factors when selecting a fumigation site:

- ◆ Ability to Heat
- ◆ Aeration Requirements
- ◆ Electrical Power Supply
- ◆ Impervious Surface
- ◆ Nonwork Area
- ◆ Water Supply
- ◆ Well-Lighted Areas
- ◆ Well-Ventilated, Sheltered Area

Ability to Heat

When cooler temperatures (below 40 °F) are expected, the fumigator **must** ensure that the commodity temperatures are maintained above 40 °F. The PPQ official will take the ambient (air) temperature 12 inches above the ground. Temperatures **must** be maintained at or above the starting treatment temperature for the entire duration of the treatment. Additionally, the PPQ official will monitor the temperature of the container using a temperature sensor and a temperature recorder. Specifications for the temperature recording system are as follows:

- ◆ Accurate to within ± 0.6 °C or ± 1.0 °F in the treatment temperature range of 4.4 °C to 26.7 °C (40 °F to 80 °F)

- ◆ Calibrated annually by the National Institute of Standards and Technology (NIST) or by the manufacturer
 - ❖ The calibration certificate will list a correction factor, if needed, and the correction factor would be applied to the actual temperature reading to obtain the true temperature.
- ◆ Capable of printing all temperature readings or downloading data to a secure source once per hour throughout the entire treatment (all temperature data **must** be accessible at a safe distance during the fumigation)
- ◆ Tamper-proof

If one or more temperature readings dip below the minimum temperature required for the selected dosage rate in the treatment schedule, the fumigation will be considered a failed treatment. The container **must** be heated to the minimum temperature in the treatment schedule and the fumigation restarted. The gas remaining in the container **does not** need to be evacuated, but additional gas may need to be added to meet the required concentration readings for a new fumigation. There are two options for re-treatment, depending on the treatment schedule used.

1. Reheat the container and restart the fumigation at the original dosage rate. The gas remaining in the container **does not** need to be evacuated, but additional gas may need to be added to meet the required concentration readings for a new fumigation.
2. Re-fumigate the container at the lower temperature using the dosage required by this manual for that temperature. (This option may **not** be available for all schedules.) The gas remaining in the container **does not** need to be evacuated, but additional gas may need to be added to meet the required concentration readings for a new fumigation.

Require the fumigator to place one temperature sensor in each container in the coldest location in the container, which will be near the floor towards the middle of the container at the end of a log-stack. If there is only one log-stack in a container, require the fumigator to place the temperature sensor near the floor at the end of the stack closest to the container doors. Refer to [Figure 2-9-1](#) for further information on temperature sensor placement.

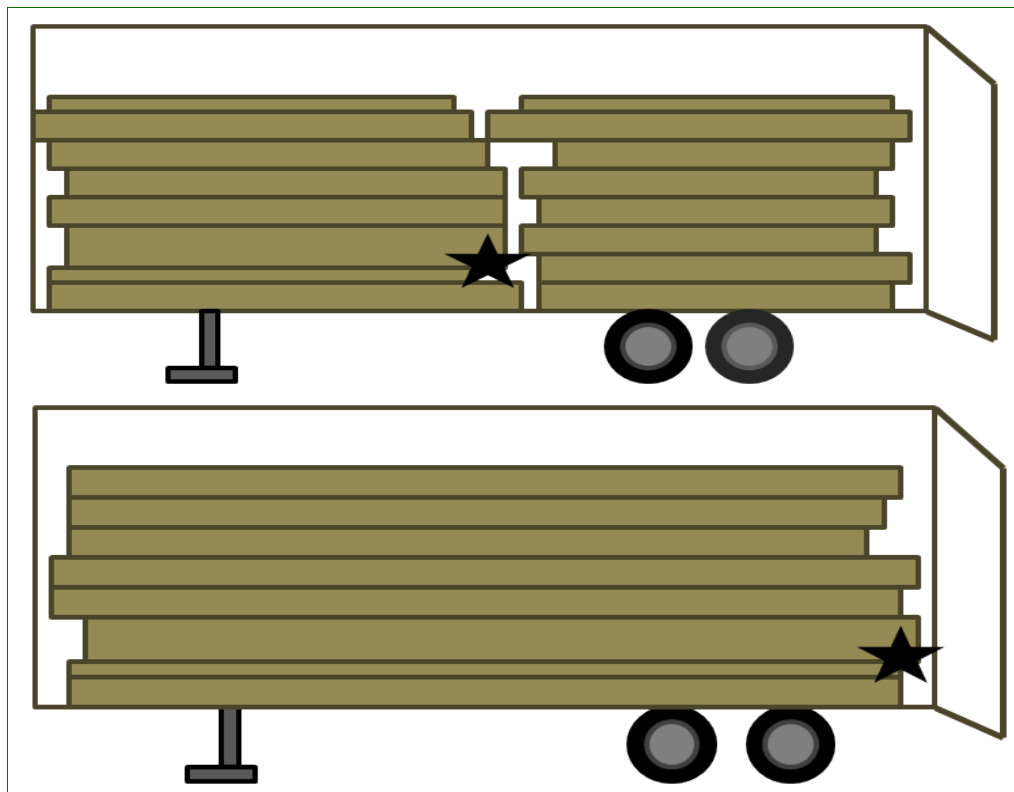

Figure 2-9-1 Diagram of placement of temperature sensors, represented by a star

Aeration Requirements

The fumigator is responsible for all aspects of aeration. Refer to xx for more information.

Electrical Power Supply

An adequate electrical source **must** be available to run the circulation fans and the gas detection device. A separate line should be available for the gas detection device. Electrical outlets **must** be grounded and conveniently located in relation to the fumigation area. PPQ does **not** allow generators to be used as a power source **except** under emergency conditions.

Impervious Surface

Select an asphalt, concrete, or tight wooden surface—**not** soil, gravel, or other porous material. If you **must** fumigate on a porous surface, require the fumigator to cover the surface with plastic tarpaulins. For large fumigations, covering the surface is **not** usually practical because pallets **must** be rearranged and heavy equipment used to move the commodity. On docks, wharfs, and piers, require the fumigator to seal cracks, holes, and manhole covers which will allow the MB to escape through the floor.

Nonwork Area - MB 2016 Label

NOTICE

The fumigator will determine the treatment buffer zone in accordance with the [Environmental Protection Agency \(EPA\) Methyl Bromide Commodity Fumigation Buffer Zone Lookup Tables](#).

The treatment buffer zone surrounds the area where access is limited during treatment. If the fumigator determines that the buffer zone is less than 30', then PPQ requires a 30' buffer zone. If the fumigator determines that the buffer zone is greater than 30', then PPQ must observe the prescribed buffer zone.

The treatment buffer zone extends from the perimeter of the enclosure to a distance determined by the fumigator in accordance with the label. Entry by any person except the PPQ official and the fumigator is prohibited except as provided in the "Exceptions to Buffer Zone Entry Restrictions" section of the label.

The treatment buffer zone begins when the fumigant is introduced into the enclosure and ends when aeration begins, at which point the aeration buffer zone requirements apply.

The fumigator must define treatment and aeration buffer zone perimeters using physical barriers (such as walls, ropes, etc.) and placards to limit access to the buffer zone. Placards must meet all label requirements regarding specific warnings, information, and language.

The fumigator will permit transiting through buffer zones in accordance with the "Transit Exception" section of the label.

Buffer Zone Overlap for Multiple Enclosures

For multiple enclosures where buffer zones overlap, the fumigator must recalculate both the treatment and aeration buffer zones in accordance with the label and supply them to the PPQ official.

Nonwork Area

The PPQ official and the fumigator **must** select a secure area where traffic and people are restricted from entering and which is isolated from people working. The fumigator **must** placards clearly in sight of all who come near. Placards **must** meet label requirements regarding specific warnings, information, and language. Placards generally include the name of the fumigant, the fumigation date, time, and the name of the company conducting the fumigation. The fumigator **must** restrict access to the warehouse to the fumigator's employees and PPQ employees monitoring the treatment. PPQ officials who work within the 30-foot perimeter **must** wear (and use) respiratory protection (SCBA), until the gas levels are safe to breathe and validated as safe by gas monitoring. The 30-foot perimeter is **not** specifically mentioned on the MB label, but is required for PPQ officials. When space is tight, it is permissible to overlap two adjoining 30-foot perimeters. However, there **must** be sufficient space for a person wearing SCBA to walk between the tarpaulins.

Water Supply

A water supply is necessary for safety purposes. Water is necessary for washing off MB if the liquid form is spilled on someone. Water is also used to fill the volatilizer. If **no** permanent water is present on a temporary site, the fumigator **must** provide a portable shower that meets OSHA specifications or a 5-gallon supply of clean water. All permanent fumigation sites **must** have a safety shower/eyewash station installed and maintained in good working order throughout the year or when fumigations are performed at the site.

Well-Lighted Areas

The fumigator will ensure that the area has adequate lighting for safety purposes and for ease in reading gas concentration, thermometers, and for determining whether a tarpaulin has holes or tears.

Well-Ventilated, Sheltered Area

The PPQ official and the fumigator **must** select sites that are well-ventilated and sheltered. A well-ventilated site is required for exhausting gas before and when the tarpaulin is removed from the container(s). Most warehouses have high ceilings and a number of windows/doors which can be used for ventilation. Some gas will escape from the tarpaulin, even in the best conditions. Avoid areas where strong drafts are likely to occur.

In warehouses, the fumigator **must** provide an exhaust system to exhaust MB to the outside of the building. The fumigator **must** ensure that the exhausted gas **does not** reenter the building, nor endanger people working outside.

When treatments are conducted in a particular location on a regular basis, the PPQ official **must** ensure that the fumigator designated a permanent site. At such sites, the fan used to remove the fumigant from the enclosure during aeration **must** be connected to a permanent stack extending above the roof level.

If fumigations are conducted outside, ensure that the fumigator selects a site that is semi-sheltered, such as the leeward side of a warehouse, pier, or building that offers some protection from severe winds. Severe winds are defined as sustained winds or gusts of 30 m.p.h. or higher for any time period. **Do not** allow the fumigator to proceed if there is a forecast from the National Weather Service of severe winds and/or thunderstorms at the beginning of, or for the entire length of the fumigation.

Step 3: Arranging the Containers

Ensure that the fumigator places **no** more than 8 containers that are 20 to 40 feet in length under a single tarpaulin. APHIS does **not** allow stacking of containers. Stacking may create too great a safety risk to the person placing the tarp, fans, and gas monitoring leads.

Containers should **not** be loaded beyond 80 percent of their capacity. **No** additional head space is required between the roof of the container and the tarp unless the pest is found on the outside of the container. If the pest is found on

the exterior of the container, then **DO NOT** use this procedure. See [Fumigants—Methyl Bromide—Tarpaulin Fumigation](#) on page 2-4-1.

Step 4: Arranging and Operating Fans

For proper gas circulation, require the fumigator to place two axial-type (blade) fans in each container. The fans **must** have the capacity to move a volume in cubic feet per minute (CFM) equivalent to the total volume of the container. Require the fumigator to place one fan at the rear of the container (doors) pointed inward, and the second fan placed in the front (nose) of the container pointed in the opposite direction. In addition, require the fumigator to place the exhaust fans and ducts as instructed in [Aeration](#) on page 2-9-21.

Step 5: Placing the Gas Introduction Lines

MB is converted from a liquid into a gas by a volatilizer. The hose that runs from the MB cylinder into the volatilizer **must** be 3000 PSI hydraulic high pressure hose with a 3/8 inch inner diameter (ID) or larger. From the volatilizer, MB gas is introduced into the structure by means of a gas introduction line. The gas introduction line **must** be a minimum of 350 PSI with a 1/2 inch ID or larger. Require the fumigator to place the introduction line directly above the fan at the rear door of the container. Each container **must** have a gas introduction line.

Step 6: Placing the Gas Sampling Tubes

Require the fumigator to install at least three gas sampling tubes per container, positioned as follows:

- ◆ Front low—near the floor at the door end of the container
- ◆ Rear high—rear of the load at the high end opposite the fan
- ◆ Middle center—mid way from front to back, at mid depth

If treating for khapra beetle, the fumigator **must** install the following additional gas sampling tubes:

- ◆ High (in the commodity)
- ◆ Low (in the commodity)

Require the fumigator to install gas sampling tubes of sufficient length to extend from the sampling position inside the container to at least 30 feet beyond the tarpaulin. Ensure that all the gas sampling tubes meet in one area for ease and safety in taking gas concentration readings. **Do not** splice gas sampling tubes. Before starting the fumigation, check for gas sampling tube blockage or pinching by connecting each tube to the gas detection device for a short time. If the line is blocked, the flow to the device will drop sharply. Tubes can also be checked with a MityVac hand pump or other air pump device. Replace any defective gas sampling tubes.

Require the fumigator to secure all gas sampling tubes under the tarpaulin and label each one at the end where the gas concentration readings will be taken. By labeling each gas sampling tube, the PPQ official will be able to record concentration readings easily.

Step 7: Padding Corners

Ensure that the fumigator looks for corners and sharp angles which could tear the tarpaulin. **Do not** allow the fumigator to use the commodity to support the tarpaulin. If the sharp angles or corners **cannot** be eliminated, the fumigator **must** cover them with burlap or other suitable padding (e.g., old tires or cloth).

Step 8: Measuring the Temperature

The PPQ official must determine the temperature of the commodity in order to select the proper dosage rate using a calibrated bimetallic, mercury, or digital long-stem thermometer.

NOTICE

Regardless of the commodity, **never** fumigate at temperatures below 40 °F.

Temperature recordings should be rounded to the nearest tenth of a degree (°C or °F)

Select several representative locations within the stack at the ends of the logs or pieces of lumber and drill holes in them to accommodate a thermometer. After drilling, wait at least 10 minutes to allow the wood around the holes to cool. Insert the thermometer into the holes drilled. All readings (**not** just the average) **must** be above 40 °F.

If fumigating multiple containers under one tarp, take temperature readings in each container under the tarp. Base the dosage calculation on the lowest reading obtained. (**Do not** average temperatures.) All readings **must** be above 40 °F to initiate the fumigation. If **not**, you **must** postpone it.

Record the temperatures in Block 22 of the PPQ Form 429A.

In the electronic 429 database, record the temperatures in the space and commodity fields in the Treatment form.

NOTICE

When the commodity and air temperature drastically differ, moisture may condense inside the gas sampling tubes or inside the gas detection device and cause inaccurate gas concentration readings. Check the gas sampling tubes frequently for possible puddling of condensed water, and drain it off, as needed, before taking a reading. Also, check the Drierite frequently, and change it as soon as it becomes saturated with water (turns pink), to obtain true gas concentration readings. **Never** fumigate commodities that are frozen.

Step 9: Covering the Stack

The fumigator **must** cover the stack, check the tarpaulin for rips, tears, and holes, look at the spots that have been taped, and verify they are properly sealed. If needed, the fumigator **must** repair all holes.

The tarpaulin should be made of a material such as vinyl, polyethylene plastic, or coated nylon.

- ◆ 4 mil vinyl or polyethylene plastic tarpaulins are only approved for one usage
- ◆ 6 mil vinyl or polyethylene plastic tarpaulins may be used up to four times with the PPQ official's approval for each usage
- ◆ 10 to 12 mil vinyl or plastic coated nylon tarpaulins may be approved for multiple uses with the PPQ official's approval for each usage

The fumigator should cover all corners and sharp ends with burlap or other padding to prevent the tarpaulin from ripping. Have the fumigator pull the tarpaulin over the containers, being careful **not** to catch or tear the tarpaulin. The tarpaulin **must** be large enough to provide a floor overlap of at least 18 inches around all sides of the stack. Carefully lay the tarpaulin out to prevent excess folds or wrinkles along the floor, especially around the corners.

Step 10: Sealing the Tarpaulin

The fumigator **must** seal the tarpaulin with loose, wet sand, sand snakes, water snakes, adhesives, or a combination. If there is danger of crushing or crimping the gas sampling or introduction tubes, use the loose, wet sand. If using snakes, use two rows of snakes along the sides and three rows on the corners. The snakes should overlap each other by approximately 1 foot. The goal in sealing the tarpaulin is to get the tarpaulin to lie flat against the floor to prevent gas from leaking out. When wind is not a factor, plastic tape may be used for sealing the tarp. The tape **must** be at least 2 inches in width, and applied (only to a smooth surface) with the aid of high-tack spray adhesive.

The fumigator **must** seal corners by laying two sand snakes around the corner and working the tarpaulin until it is flat. Place a third snake on top of the two other snakes to provide additional weight to force the tarpaulin against the

floor. Loose, wet sand can be used in the area where the gas introduction line, electrical cords, and gas sampling tubes extend from under the tarpaulin.

Step 11: Measuring the Volume

Using a 100-foot tape measure, the PPQ official and the fumigator **must** carefully measure the length, width, and height of the container. The area underneath the container is **not** included in the calculations. **Never** estimate the measurements. When measuring, round off to the nearest quarter foot (Example: 3 inches = .25 feet).

Formula for determining volume:

Length x width x height = volume in cubic feet

EXAMPLE A stack with measurements H=10'6", L=42'3", and W=10'9"
 $10.50 \times 42.25 \times 10.75 = 4,768.9 \text{ ft}^3$ round to 4,769 ft^3

The PPQ official must record volume in Block 26 of the PPQ Form 429A.

In the electronic 429 database, record the length, width, and height in the corresponding fields under the "AMT of Gas Introduced" heading on the Treatment form. The total volume of the enclosure will be calculated.

Step 12: Calculating the Dosage

The PPQ official must calculate dosage by doing the following:

1. Refer to the treatment schedule for the correct dosage rate (lbs./1,000 ft^3) based on temperature ($^{\circ}\text{F}$).
2. Multiply by the dosage (lbs./1,000 ft^3) rate by the volume (ft^3) to get the dosage in pounds.

Round to the nearest 1/4 pound.

The formula for calculating dosage is:

$$\text{Dosage (lbs.)} = \frac{\text{Volume (ft}^3\text{)} \times \text{Dosage Rate (lbs.)}}{1,000 \text{ ft}^3}$$

Figure 2-9-2 Formula for Calculating MB Dosage for Closed-Door Container Fumigations

In the electronic 429 database, the PPQ official must enter the dosage rate in the “dosage” field and the total amount of gas required for the fumigation will be displayed in the “GAS REQUIRED” field.

Step 13: Making a Final Check

Before introducing the gas, the PPQ official and the fumigator must ensure that the following activities are performed:

- ◆ Check tarpaulin to make sure it is free from rips and tears
- ◆ Check that all gas sampling tubes are labeled and are **not** crimped or crushed.
 - ❖ Visually inspect tubes, or use a T/C analyzer, an electric pump, or a Mityvac[®] hand pump to check tubes for unrestricted flow

NOTICE

Erroneous gas readings may occur if the sampling tubes become blocked or crimped. It would be impossible to install new sampling tubes during the fumigation. To avoid an unsuccessful fumigation, test sampling tubes before the treatment begins.

Refer to the following steps to test the sampling tubes using a MityVac pump: (See [Mityvac Hand-Held Vacuum Pump](#) on page 8-1-23)

1. Prior to gas introduction, connect a MityVac hand-held vacuum pump to a sampling tube.
2. Squeeze the handle on the MityVac unit. If the line is blocked, a vacuum will be indicated on the MityVac gauge. For sampling tubes longer than 25 feet, squeeze the handle two or three times. The MityVac pump has the capacity to attain and hold 25 inches of Hg vacuum and a minimum of 7 psig pressure.
3. Disconnect the MityVac pump from the sampling tube and repeat this procedure for each sampling tube.

- ◆ Check that all safety equipment, especially SCBA is available and in working order.
- ◆ Check that tarpaulin is placarded and the area is secured. Only people working on the fumigation may be in the area.
- ◆ Check that there is enough gas in the cylinder and, if necessary, that other cylinders are available.
- ◆ Check that the gas introduction line connections are tight and free of leaks.
- ◆ If using a T/C, install Drierite[®] and Ascarite[®] tubes as stated in the instructions in this manual.

NOTICE

Other gas detection devices may **not** require the use of Drierite[®] or Ascarite[®].

- ◆ Place fumigant cylinder with gas introduction line on scale and take initial weight reading.

- ❖ Ensure the gas introduction hose is attached to the cylinder.
- ❖ After obtaining the correct weight, subtract the dosage to be introduced into the enclosure.
- ❖ After the fumigator has introduced the proper amount of gas, the scale will be balanced.
- ◆ Start volatilizer and heat water to 200 °F or above. A minimum temperature of 150 °F is required at all times during the introduction process. Refer to Chapter 8-Equipment for temperature monitoring procedures.
- ◆ Turn on all fans and APHIS-approved gas detection devices to make sure they work.
- ◆ Warm up and zero (if required) APHIS-approved gas detection devices as described in Chapter 8-Equipment.

Conducting the Fumigation

Step 1: Introducing the Gas

CAUTION

The PPQ official must wear SCBA anytime the MB concentration level in the air is unknown or greater than or equal to 5 ppm.

MB 2016 Label

NOTICE

If MB concentration levels are between 1-4 ppm, the PPQ official and the fumigator may wear an air purifying respirator NIOSH certified half-mask or full face piece with a cartridge.

Require the fumigator to use SCBA while introducing and adding gas. Ensure that the fumigator turns on all fans before introducing the gas. When using large cylinders of MB, the fumigator should slightly open the cylinder valve, then close the valve. With an APHIS-approved continuous real time gas detection device, the fumigator **must** check all connections on the gas introduction hose for leaks. If leaks are found, the fumigator **must** tighten the connections and repeat the test. When **no** leaks are found, require the fumigator to open the valve to the point where 3 to 4 pounds of MB are being introduced per minute. The water temperature in the volatilizer should **never** go below 150 °F at any time during gas introduction. The water in the volatilizer may include antifreeze and should be handled with the appropriate safeguards.

The fumigation time begins once all the gas has been introduced. The PPQ official **must** record the time gas introduction was started and completed in Block 32 on the PPQ Form 429A.

In the electronic 429 database, record the fumigation date, gas introduction start and finish time in the corresponding fields under the “GAS INTRODUCTION” heading on the Treatment form.

Require the fumigator to run the fans for **60 minutes** to achieve even gas distribution. After gas is evenly distributed, require the fumigator to turn the fans off. The PPQ official **must** take the initial concentration reading **60 minutes** after all the gas has been introduced.

NOTICE

Do not begin counting fumigation time until all the gas has been introduced and the valve on the MB tank is closed.

Step 2: Testing for Leaks

Require the fumigator to wear the SCBA while checking for leaks. The fumigator **must** use an APHIS-approved leak detection device to test for leaks before the 60 minute reading or anytime when the concentration level is unknown or above 5 ppm. The fumigator **must** test around the perimeter of the tarpaulin on the floor, corners, and especially where electric cords, gas sampling tubes, or gas introduction lines are present. When the fumigator detects leaks, ensure they are sealed using more sand or sand snakes for floor leaks and tape for sealing small holes in the tarpaulin. Use loose, wet sand to reduce leakage from electric cords, gas sampling tubes, gas introduction lines, or uneven flooring.

NOTICE

If an employee encounters unsafe conditions (such as holes in the tarpaulin or a breach in safety protocol) and the condition(s) **cannot** be corrected in a timely manner, the employee may CANCEL the fumigation. Consult with a PPQ Supervisor prior to cancellation.

If the fumigator detects excessive leakage (concentration readings of 50 percent or less of the minimum concentration) in a tarpaulin which **cannot** be corrected in a practical way, do **not** attempt to correct the problem by adding more gas. Require the fumigator to quickly evacuate the remaining gas from the enclosure, eliminate the problem, and construct a new enclosure. Aerate as usual following procedures on [page 2-9-21](#). Record the aborted fumigation in Block 40 (Remarks) of the PPQ Form 429A or in the “Remarks” form in the electronic 429 database. Restart the fumigation in the new enclosure.

Any “closed-door” treatment that is aborted **cannot** be retreated until the remaining containers have completed treatment and all have aerated for a minimum of 48 hours. Refumigate aborted containers with both container doors open. Report aborted fumigations in the 429A as required by the Environmental Protection Agency.

Step 3: Taking Concentration Readings

NOTICE

Before taking a reading, always purge sampling lines with a mechanical or hand pump. If using a T/C unit, connect it to the sampling lead, adjust the gas flow rate to 1.0, and wait until the meter registering “ounces per thousand cubic feet” stabilizes before taking a reading. (This may take a minute or more, depending upon the length of the tubing and whether or **not** an auxiliary pump is used.)

The PPQ official **must** take concentration readings with an APHIS-approved gas detection device to determine the gas concentration and distribution within the enclosure. If used, check desiccant tubes before each reading and change Drierite[®] if its color is pink. Allow gas concentration readings to stabilize; do **not** disconnect the sampling line from the gas detection device when the minimum concentration reading has been met.

Take concentration readings at the times designated in the treatment schedule. Concentration readings should **not** differ more than **10 ounces** among the leads. If they do, run the fans for an additional 30 minutes and take another reading to verify that gas concentration levels have equalized. In some cases, several cycles of fan operation may be necessary to equalize the readings. Record all gas readings on the PPQ Form 429A or in the electronic 429 database. Regardless of the number of containers under each tarp, every container **must** have a separate 429 record.

CAUTION

Avoid using hand-held two-way radios near the T/C unit. Using two-way radios near the T/C unit will interfere with an accurate concentration reading.

Step 4: Determining the Need to Add Gas and Adjust Exposure

If the lowest gas reading is **BELOW** the required minimum indicated by the treatment schedule, you **must** add gas and extend the exposure period. Use the formula in [Figure 2-9-3](#) to determine the amount of gas to add.

$$1.6 \times \text{number of ounces below minimum} \times \frac{\text{volume in cubic feet}}{1000 \text{ cubic feet}} \times \frac{1}{16} = \text{pounds of gas to add}$$

Figure 2-9-3 Formula for Determining the Amount of Gas to Add to Closed-Door Containerized Cargo

Use [Table 2-9-1](#) to determine how long to extend the exposure period.

Table 2-9-1 Determine the Extended Exposure Period for Closed-Door Containerized Cargo

If any individual reading is below minimum by: ¹	Then extend exposure:
10 oz. or less	10 percent of the time lapse since gas introduction or the last acceptable reading
11 oz. or more	2 hours or 10 percent of time lapse since last acceptable reading, whichever is greater

¹ If any individual reading is 50 percent or more below the minimum concentration reading, then abort the treatment. For oak logs (T312-a, T312-a-alternative), refer to [Table 5-4-3 on page 38](#) or [Table 5-4-4 on page 41](#) in the section [Special Procedures for Adding Gas to Oak Logs Using T312 or T312-a-Alternative](#) on page 5-4-36 for specific instructions.

Require the fumigator to follow these procedures when adding gas:

1. Heat water in volatilizer.
2. Turn on fans.
3. Weigh the cylinder.
4. With SCBA on, open cylinder valve and introduce the gas.
5. Close valve when the weight of the cylinder indicates that the needed amount of gas has been added.

The PPQ official **must** record quantity of fumigant added in Block 34 and the additional fan time in Block 30 of the PPQ Form 429A.

In the electronic 429, record the amount of additional gas listed in the Treatment Manual in the “Additional Gas Recommended” field and the actual amount of additional gas added in the “ACTUAL ADDITIONAL GAS” field. Record the additional fan time in the “TIME FANS OPERATED” field in the Treatment form.

Note the time the fumigator started introducing additional gas and the time the fumigator finished introducing gas and record in Block 40 (Remarks) of the

PPQ Form 429A or in the “Remarks” form in the electronic 429 database. Run the fans for **30 minutes**. Turn off fans, then take a concentration reading. If all readings are above minimum concentration levels and within **10 ounces** of each other, then proceed as usual with the remaining scheduled concentration readings. If the readings are **not** above the minimum or within 10 ounces of each other, run the fans for another 30 minutes. It may take several cycles to stabilize the gas concentration.

Step 5: Exhausting the Gas

Require the fumigator to exhaust the gas at the completion of the exposure period.

Aeration

The fumigator must:

- ◆ Arrange for the aeration to proceed once the treatment is completed.
- ◆ Consider the wind direction when pointing the exhaust duct, and face the duct outlet toward an open area away from people.
- ◆ Ensure that, during the first 10 minutes of aeration, no one is present within 200 feet downwind of the exhaust duct outlet.
- ◆ Determine aeration buffer zones in accordance with [Environmental Protection Agency \(EPA\) Methyl Bromide Commodity Fumigation Buffer Zone Lookup Tables](#).
- ◆ Ensure no one is present within the perimeter of the aeration buffer zone unless they are wearing SCBA.
- ◆ Refer to “Buffer Zone Overlap for Multiple Enclosures”.
- ◆ Follow all label instructions, state, county, and local regulations, in addition to the instructions in this manual.
- ◆ Inform people located in occupied structures and personnel in the immediate area within the buffer zone that release of MB is about to take place and give them the option of leaving the area or remaining inside the building.
- ◆ Restrict access to the area where the exhaust duct extends beyond the enclosure.

Wearing Respiratory Protection

The fumigator **must** wear approved respiratory protection (SCBA, supplied air respirator, or a combination unit) when:

- ◆ A risk of exposure to concentrations above 5 ppm exists; this includes any time the concentration is unknown

- ◆ Setting up the air introduction and exhaust system
- ◆ Opening the container door(s)
- ◆ Opening the tarpaulin for aeration

MB 2016 Label

NOTICE

If MB concentration levels are between 1-4 ppm, the PPQ official and the fumigator may wear an air purifying respirator NIOSH certified half-mask or full face piece with a cartridge.

Advise the fumigator to:

- ◆ Install an exhaust fan (minimum of 5,200 cfm capacity) with one end of a round ventilation duct at least 16 inches in diameter, oriented so that the fan pulls air through the duct. The fan dimensions should complement the diameter of the duct work chosen, fitting flush and tight so that **no** leaks exist between the fan and duct. For indoor fumigations, extend the exhaust duct (fan end) at least 30 feet beyond the building or into a vertical stack extending through the roof. For outdoor fumigations, the exhaust duct will be at least 30 feet in length with the fan end placed external and alongside the container extending toward the nose, so the exhaust air is directed away from the end of the container which is opened during aeration.

Palletized Partial Loads

For palletized partial loads (where at least 2 feet of open space is present at the door end of the container), extend the exhaust duct intake (non-fan end) on the container floor with the duct face flush against the bottom of the load along a side of the container. Store the remaining section of the exhaust duct and fan at the rear of the load so it is easily accessible at the start of aeration.

Full Loads

For full loads (where less than 2 feet of open space is available at the door end of the container and there is **no** central aisle between pallets), if there is room to store the exhaust duct inside the container during fumigation, secure the exhaust duct intake (non-fan end) face flush against the load at the floor/pallet/commodity interface along a side of the container so it will **not** shift or twist during aeration. Use straps, ties, or other fasteners to secure this interface tightly. If there is **not** sufficient room to pre-install the exhaust duct prior to fumigation, carry out these steps at the start of aeration.

For partial or full loads where a central aisle exists between the pallets, run the exhaust intake duct along the floor center and extend 1-2 feet into this space, if possible. Store the remaining section of the exhaust duct and fan at the rear of the load so it is easily accessible at the start of aeration.

Non-Palletized Logs

For non-palletized logs, secure the duct face flush against the load at the floor/interface on a side of the container so it will **not** shift or twist during aeration.

NOTICE

If commodities other than logs are **not** palletized, consult S&T-TMT before treatment.

- ◆ Integrate an air introduction fan (minimum 3,750 cfm) with a round ventilation duct at least 12 inches in diameter, oriented so that the fan pushes the air through the duct. The fan dimensions should complement the diameter of duct work chosen, fitting flush and tight so that **no** leaks exist between the fan and duct. Extend the introduction duct (non-fan end) along top of the load two-thirds of the length of the container. For partial loads, the intake duct may run along the container floor, with the end placed on top of the load. Store the remaining introduction duct and fan at the rear of the load so it is easily accessible at the start of aeration.
- ◆ Integrate an additional exhaust fan (minimum of 5,200 cfm capacity) with one end of a round ventilation duct at least 16 inches in diameter, oriented so that the fan pulls air through the duct. The fan dimensions should complement the diameter of duct work chosen, fitting flush and tight so that **no** leaks exist between the fan and duct. This duct will be used to aerate the space between the container and tarp prior to tarp removal. The duct length should be approximately 10 feet and should remain outside the tarp during fumigation.

NOTICE

Install introduction and exhaust ducts prior to fumigation in order to limit human exposure to the fumigant at the start of aeration.

Refer to [Figure 2-9-4](#) for detailed diagrams of air and exhaust ducts. In this diagram, air introduction ducts are blue and exhaust ducts are red.

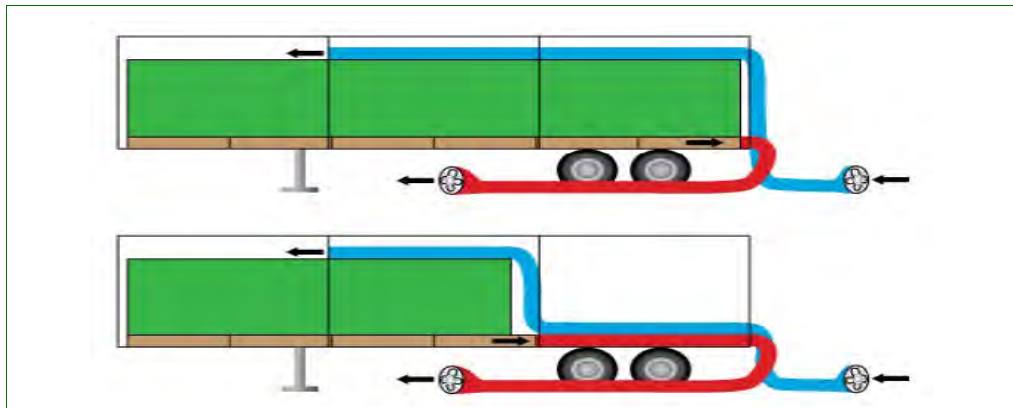

Figure 2-9-4 Duct work configuration for aeration of closed-door containers: full loads (top) and partial loads (bottom)

Step 6: Aerating the Commodity

Advise the fumigator to:

1. While wearing SCBA, insert a spacer (at least 16 square inches in area) to vent the tarpaulin at the nose end of the container. At the opposite end of the tarp, insert the additional exhaust duct 5 feet under the tarp and turn the fan on.
2. Exhaust the gas from underneath the containers before opening the doors of the containers for at least 15 minutes or until the gas concentration level underneath the containers is below 5 ppm.
3. While wearing SCBA, remove the tarp when the gas concentration level underneath the containers is below 5 ppm.
4. With the tarp removed and while wearing SCBA, turn off the fan used to aerate the space and open the doors of each container.
5. Turn on all fumigant circulation fans inside the container and leave them on throughout the aeration.
6. Start the container introduction and exhaust ducts fans. Require a minimum of 4 hours aeration for all sorptive commodities. Sorptive commodities generally require 12 hours or longer to aerate; however, since sorptive commodities vary in their rates of desorption, aeration may be completed in less than 12 hours.
7. Aerate oak logs and lumber a minimum of 48 hours. If, after 48 hours, the concentration is 5 ppm or greater, continue aeration for 24 more hours. Continue this procedure until concentration readings are less than 5 ppm.
8. Stop the fans and take concentration readings with colorimetric tubes in the airspace around and, when feasible, within the log stack.
9. RELEASE the commodity when the concentration reading is 5 ppm or less.

Chemical Treatments

Fumigants—Sulfuryl Fluoride

Contents

Properties and Use	2-10-1
Leak Detection	2-10-2
Tarpaulin Fumigation	2-10-2
Sealing	2-10-2
Circulation	2-10-3
Prevention of Condensation	2-10-3
Gas Sampling Lines	2-10-3
Gas Introduction	2-10-3
Dosage Rate	2-10-4
Measure Gas Concentrations	2-10-5
Replacing Lost Gas	2-10-5
Aeration	2-10-5
Structural Fumigation	2-10-5
Chamber Fumigation	2-10-6
Shipboard Fumigation	2-10-6
Safety and First Aid	2-10-6
Protective Clothing	2-10-6
If SF is Inhaled	2-10-7
If Liquid SF is Spilled on the Skin	2-10-7
If Liquid SF is in the Eyes	2-10-7

Consult the Vikane¹ Gas Fumigant Label and Structural Fumigation Manual for more detailed instructions and additional supportive information.

Properties and Use

Sulfuryl fluoride (SF) is a compressed-gas fumigant which is used primarily against insects that attack wood. The following characteristics make this fumigant especially desirable:

- ◆ 2.88 times heavier than air
- ◆ High vapor pressure—13,442 mm Hg @ 770 °F
- ◆ Low solubility in water and low sorption by soil or commodity
- ◆ Odorless, colorless, and nonflammable

¹ Trademark of Dow AgroSciences

- ◆ Penetrates wood better than any other commercial fumigants, including methyl bromide
- ◆ Relatively nonreactive
- ◆ Very low loss through plastic tarpaulins

SF boils at minus 67 °F. SF is **not** registered for use on foodstuffs or on living plant material.

SF is effective at very low dosages on dry wood termites where control of the adult stage is the only concern (typically 0.5 to 1.0 lbs/1,000²). Higher dosages are required for control of the egg stage of other insects (typically 3 to 5 lbs/1,000²). Consult treatment schedules in this manual for specific dosages.

Leak Detection

Interscan (Model GF 1900) or Miran gas analyzers (these units are portable) may be used to detect SF in the range of 0 to 150 ppm respectively. Consult the Vikane Structural Fumigation Manual for further instructions. Colorimetric (“detector”) tubes are **not** available for detecting SF gas leaks around tarpaulins, chambers, and application equipment.

Tarpaulin Fumigation

NOTICE

Refer to the Vikane label and Vikane Structural Fumigation Manual for a detailed discussion of proper procedures.

Also, refer to [Fumigants—Methyl Bromide—Tarpaulin Fumigation](#) for additional information on the following:

- ◆ Placing gas sampling lines
- ◆ Sealing tarpaulins
- ◆ Securing fumigation areas
- ◆ Selecting fumigation sites
- ◆ Taking concentration readings

Sealing

The commodity to be fumigated should be placed onto a relatively even and non-porous surface, such as concrete, asphalt, or macadam. Special attention should be given to the seal along the ground or floor. The inspector should have tape, sand, or water snakes properly positioned.

Circulation

Fans are necessary to distribute SF and to help prevent condensation. The number of fans depends upon the cubic volume of the enclosure being treated, and the arrangement of cargo. Axial fans of approximately 5,000 cfm have proven effective. Usually two fans are used, one on either end facing the lower center and upper center of the load. If the enclosure is over 35 feet long, additional fans should be used. It is usually **not** necessary to run fans longer than 15 minutes after the gas has been introduced.

Prevention of Condensation

In cool weather, moisture may condense under tarpaulins if the sun is shining directly on the load. Continuous air circulation can prevent this from occurring. Do **not** tarp or seal any item while it is wet.

Gas Sampling Lines

A thermal conductivity unit calibrated for Vikane **must** be available for readings. Sampling lines should be arranged so that gas samples are drawn from representative parts of the fumigation area and lead to a common point.

A minimum of three sampling lines should be placed in enclosures of up to 10,000 ft³ at the following locations:

- ◆ Center of the load, midway from the bottom to the top of the load
- ◆ Front of the load, 3 inches from the floor
- ◆ Rear of the load, at the top

When 10,000 to 15,000 ft³ are being treated, two additional lines should be appropriately deployed.

Gas Introduction

Unlike methyl bromide, SF does **not** require the use of a volatilizer to speed up its conversion from a liquid to a gas. The gas introduction tube should be placed directly in the air flow of a fan away from the cargo. Also, place a drip cloth under the tube. The introduction rate is controlled by the introduction line length and diameter. A 1/8-inch-inside-diameter by 100-foot-long hose will allow a flow rate of approximately 2 pounds per minute, while a 25-foot-long hose will allow approximately 4 pounds per minute.

Table 2-10-1 Effect of Hose Inside Diameter on Rate of Gas Introduction through a 25-Foot Hose (approximates, depending on cylinder pressure)

Inside Diameter (inches)	Vikane Per Minute (pounds)
1/8	4
1/4	20
1/2	45

Table 2-10-2 Effect of Hose Length on Rate of Gas Introduction Through a 1/8-Inch Inside Diameter Hose

Hose Length (in feet)	Pounds Vikane Per Minute
25 ft	4.0
50 ft	2.8
100 ft	2.0 ¹

1 Where fumigant introduction rates lower than 2 lbs/min are needed, a longer hose can be used, e.g., 200 ft.

It is important **not** to overshoot the ability of the fan to rapidly disperse the cool air near the fumigant introduction site. Fan capacity should be at least 1,000 cfm for each pound of Vikane introduced per minute. In addition, a volatilizer (heat exchanger) may be used in fumigating containers or small chambers to prevent a “fog-out” (condensation) which could cause corrosion or damage to the contents. The last few pounds of fumigant will turn to gas within the cylinder before moving out, and the flow rate will be reduced. The cylinder and tubing will often become frosted. Be certain that **no** open flame or glowing hot surfaces above 400 °C are present since corrosive substances (mainly hydrofluoric acid) are formed when SF is exposed to such conditions. To avoid possible damage, do **not** apply the fumigant directly to any surface.

Dosage Rate

To control a particular pest, locate the proper fumigation schedule to be followed in the Treatment Manual. The three variables in these schedules are temperature, dosage, and exposure duration. Treatment is **not** recommended below 50 °F. Dosages are in pounds per 1,000 feet³ of space. To determine the total amount of fumigant required by weight in pounds, divide the total volume of space by 1,000. Then multiply the resulting figure by the dosage rate schedule expressed in pounds (per 1,000 feet³). The cylinder should be placed on a scale, and the flow of gas is controlled by the valve and introduction line until the desired cylinder end-weight is obtained. The valve should be turned fully open to fill the fumigant introduction hose with liquid SF. Initially, the valve should be opened slightly until flow has begun and then opened about one full turn, giving full flow through the 1/8” fumigant introduction hose.

Measure Gas Concentrations

During the course of fumigation, minimum concentrations **must** be maintained according to the schedules used. Readings on the thermal conductivity if **not** calibrated for Vikane, **must** be multiplied by a factor to obtain the actual ounces per 1,000 feet³ present. Contact the USDA-APHIS-PPQ-S&T-TMT for calibration information. Record the gas reading without the multiplied factor on PPQ Form 429A and the electronic 429 database. Do **not** use filters containing sodium hydroxide (Ascarite) with SF. Fresh desiccant (Drierite) should be used with the T/C unit. Desiccant should be changed at appropriate intervals to insure accurate readings.

Replacing Lost Gas

When it appears that additional SF will be needed, the officer should use their best judgment to determine the amount of gas to add, according to the prevailing conditions of tarpaulin tightness or wind conditions. Usually, 1.6 oz. of gas should be added for every ounce of deficiency in the minimum concentration required.

Aeration

For detailed guidelines, consult the Vikane Gas Fumigant label, Vikane Structural Fumigation Manual, and [Aeration](#) on page 2-4-38. The threshold limit value for SF is 5 ppm (20 mg/cubic meter), the same as for MB. Since **no** colorimetric (“detector”) tubes are available for SF, a suitable instrument **must** be used, such as the Interscan GF 1900 or Miran (calibrated for SF).

Structural Fumigation

Refer to the section on MB structural fumigation (or aeration) in this manual, the Vikane label, and Vikane Structural Fumigation Manual for a detailed discussion of proper procedures.

When preparing a structure for fumigation with SF, the surrounding soil should be watered thoroughly at the base of trees, shrubs, and other ornamental plants around the perimeter of the structure to prevent loss of fumigant into the soil. Watering around the plants will protect the roots; however, plants and grass closer than 1 foot may die even if this precaution is taken.

Before placing the tarpaulin over the structure, be sure to remove items for which the use of SF is **not** registered. These include food, feed, drugs, and medicines. Extinguish all flames (including pilot lights), unplug all heating elements, and turn off all lights. Open all internal doors.

Chamber Fumigation

Refer to the section on MB chamber fumigation (and aeration) in this manual, the Vikane label, and Vikane Structural Fumigation Manual for a detailed discussion of proper procedures.

CAUTION

Trying to measure out a small quantity of SF in a graduated glass tube (sight gauge)—which is common practice with MB chamber fumigations—should **never** be attempted with SF because the cylinder pressure is much greater, and the glass gauge may explode and shatter.

The gas will generally be introduced through a volatilizer or heat exchanger in order to prevent a “fog-out” which could damage the contents. Introducing a very small amount of gas into a small chamber, however, is difficult to do with precise accuracy because the amount introduced **must** be calculated by weight loss from the cylinder. The scale used beneath the cylinder **must** be readable in ounces or grams, **not** just in pounds or kilograms.

Shipboard Fumigation

Refer to the section on MB ship fumigation (and aeration) in this manual, the Vikane label, and Vikane Structural Fumigation Manual for a detailed discussion of proper procedures. Surface ships (only those in port) must be fumigated at dock side, and not when the vessels are underway. Shipboard fumigation is also regulated by the U.S. Coast Guard (Department of Transportation). That regulation appears as 46CFR 147A.

Safety and First Aid

Read and understand all directions and safety precautions on the Vikane label before applying. Additional information is presented in the Vikane Structural Fumigation Manual. There is **no** known antidote for SF. Vikane is odorless. However, the chance of a lethal exposure is **not** probable unless an individual actually enters the fumigation space. An SCBA **must** be worn by anyone in the fumigated areas when the level exceeds 5 ppm.

Protective Clothing

Wear goggles or full face shield for eye protection during introduction of the fumigant. Do **not** wear gloves or rubber boots. Do **not** reuse clothing or shoes that have become contaminated with liquid SF until thoroughly aerated and cleaned.

If SF is Inhaled

An individual who has inhaled high concentrations of SF may exhibit the following symptoms:

- ◆ Difficulty breathing
- ◆ Dulled awareness
- ◆ Nausea
- ◆ Numbness in the extremities
- ◆ Slowed body movements
- ◆ Slowed or garbled speech

If any of the above symptoms appear, immediately do the following:

- ◆ Remove the victim to fresh air
- ◆ Put victim at complete rest
- ◆ Keep the victim warm and see that breathing is normal and unhampered; if breathing has stopped, give artificial respiration
- ◆ Do **not** give anything by mouth to an unconscious person
- ◆ Obtain medical assistance

If Liquid SF is Spilled on the Skin

Immediately apply water to the contaminated area of clothing before removing. Wash contaminated skin thoroughly or shower.

If Liquid SF is in the Eyes

Flush with plenty of water for at least 20 minutes, and get medical attention. Damage to the eye may result from cold or freezing temperatures.

Chemical Treatments

Fumigants—Phosphine

Contents

Properties and Use	2-11-1
Phosphine	2-11-3
Carbon Dioxide	2-11-4
Leak Detection: Gas Analysis	2-11-4
Safety	2-11-5
Applicator Requirements	2-11-5
Storage and Handling	2-11-5
First Aid Treatment	2-11-6
Respiratory Protection	2-11-7
MP, AP, ECO ₂ FUME [®] , and VAPORPH ₃ OS [®]	2-11-9
Packaging	2-11-9
Dispensing ECO ₂ FUME [®] Fumigant Gas	2-11-11
Blending VAPORPH ₃ OS [®] Fumigant Gas	2-11-15
Dosage	2-11-18
Preparing to Fumigate Break Bulk Cargo	2-11-21
Preparing to Fumigate Containerized Cargo	2-11-28
Preparing to Fumigate Bulk Commodities	2-11-29
Probing	2-11-30
Aeration Requirements	2-11-31
Contacts	2-11-32
Cytec [®]	2-11-32
USDA-APHIS-PPQ-S&T-TMT	2-11-32

Properties and Use

There are a number of phosphine formulations registered with the United States Environmental Protection Agency (EPA) to control a variety of insects currently infesting raw agricultural commodities, processed foods, animal feed, feed ingredients, and nonfood commodities, including tobacco. Aluminum phosphine (AP), magnesium phosphide (MP), ECO₂FUME[®] and VAPORPH₃OS[®] are phosphine formulations that are currently approved for use by Plant Protection and Quarantine (PPQ). Always refer to this manual to determine if there is an available treatment. There are commodities and pests listed on the labels that are **not** authorized for treatment by USDA PPQ.

AP and MP are solid products and are available under various trade names (Table 2-11-2) as tablets, pellets, prepacs, bags, or plates. In the presence of moisture, phosphine (hydrogen phosphide, PH_3) a colorless gas, is emitted from the solid product.

The flash point of PH is 212 °F. Direct contact with a liquid could cause spontaneous combustion. In case of fire, a CO_2 dry chemical fire extinguisher should be used. *Never use water to extinguish a PH-ignited fire.* PH has an odor somewhat like garlic, which enables the gas to serve as its own warning agent. However, under some conditions, the odor can be lost, even at high toxic concentrations.

ECO₂FUME® fumigant gas is a nonflammable, premixed mixture of phosphine and carbon dioxide. The phosphine is liquefied and mixed with carbon dioxide in high-pressure cylinders for shipment. Phosphine, the active ingredient, makes up 2 percent by weight (2.6 percent by volume) of the product. The carbon dioxide is used as a propellant and a flame inhibitor, making the product nonflammable in air. Do **not** store the fumigant near heat or open flame. Do **not** drop, puncture, or incinerate the cylinder.

Under pressure, ECO₂FUME® is a poisonous liquefied gas. The product is withdrawn from the cylinder as a liquid, but dispensed as a gas. When expanding from a liquid to a gas, the volume of ECO₂FUME® is multiplied by hundreds. Proper dispensing equipment (see [Dispensing ECO₂FUME® Fumigant Gas](#) on page 2-11-11) is necessary to ensure a safe and effective fumigation; therefore, always contact the manufacturer concerning proper dispensing equipment for the fumigant. Fumigators should provide PPQ with all [Cytex®](#) equipment authorization documentation. The documentation should be on file and available for periodic audits by the USDA.

The rate at which phosphine is dispensed is **not** dependent on temperature or humidity, but on the dispensing equipment used. Unlike metal phosphide fumigants, the phosphine is **not** generated through a chemical reaction and its release is instantaneous. The choice of dispensing methods will depend on the type and duration of the fumigation planned.

VAPORPH₃OS® consists of 100 percent phosphine gas packaged in high-pressure gas cylinders. Unlike solid phosphide fumigants, the phosphine is **not** generated through a chemical reaction and its release is instantaneous. Phosphine is pyrophoric and will spontaneously ignite in air. Phosphine is dispensed as a gas from the cylinder and can be safely blended with carbon dioxide to less than 3 percent volume (30,000 ppm) or diluted with the surrounding air to 1 percent volume (10,000 ppm) to eliminate the

flammability hazard. Contact the manufacturer for approved blending equipment necessary to ensure a safe and effective fumigation. **Never** store the cylinders where the temperature will exceed 125 °F. Fumigators should provide PPQ with all Cytac[®] equipment authorization documentation. The documentation should be on file and available for periodic audits by the USDA.

Phosphine

Phosphine (PH) is highly toxic to humans and other animals. Avoid exposure to nontarget organisms. The current U.S. OSHA Permissible Exposure Limit (PEL) for phosphine is 0.3 ppm as an 8-hour time weighted average. The Short Term Exposure Limit (STEL) for phosphine is 1 ppm as a 15-minute time weighted average.

Phosphine is colorless and, at concentrations below the OSHA PEL, has the odor of decaying fish or garlic. Intermittent low concentration exposure may cause headaches, malaise, ringing of ears, fatigue, nausea, and chest pressure. Moderate exposure causes weakness, vomiting, and pain in the stomach and chest with difficult breathing. Phosphine gas reacts with moisture to form phosphoric acid, which causes pulmonary edema.

Phosphine may spontaneously ignite in air at levels above its lower flammability limit of 1.8 percent v/v (18,000 ppm). Do **not** exceed this concentration because, under these conditions, explosions can occur that could cause severe personal injury. **Never** allow the buildup of phosphine to exceed explosive concentrations.

Under high vacuum conditions, phosphine gas can cause an explosive hazard. **Do not apply either fumigant in vacuum chambers.**

Phosphine can react with certain metals and cause corrosion (especially at higher temperatures and lower relative humidity). **Gold, silver, copper, brass, and other copper alloys are susceptible to corrosion.**

 **CAUTION**

Remove or protect the following items prior to fumigation:

- ◆ Batteries and battery chargers
- ◆ Brass sprinkler heads
- ◆ Communication devices
- ◆ Computers
- ◆ Electric motors
- ◆ Electronic or electrical equipment
- ◆ Fork lifts
- ◆ Smoke detectors
- ◆ Switching gears
- ◆ Temperature monitoring systems

Fans and blowers used with phosphine products should be manufactured from materials resistant to the fumigant. Aluminum or plastic wheels and housings are preferred. For phosphine fumigations, always contact the manufacturer for recommended fan and blower types.

Carbon Dioxide

In a liquefied state and when contact is made with exposed areas of the body, carbon dioxide can cause frostbite and freeze burns. Overexposure to carbon dioxide at low levels can cause headache, nausea, weakness, confusion, and labored breathing. Overexposure to higher concentrations can cause excitation, dizziness, euphoria, loss of consciousness, coma, and death.

The current U.S. OSHA PEL for carbon dioxide is 5,000 ppm as an 8-hour time weighted average.

Leak Detection: Gas Analysis

Phosphine levels can be detected using either colorimetric detector tubes or any approved electronic instrument, such as the PortaSens detector. (See [Phosphine Detector](#) on page 8-1-23 for instructions on how to use the PortaSens.) This equipment is used to determine both the high (fumigation concentration) and low (personnel safety) levels of PH. Do **not** use thermal conductivity (T/C) units to measure PH.

Safety

Applicator Requirements

Before using ECO₂FUME[®] and VAPORPH₃OS[®], all users (fumigators) are required to attend the fumigant gas product stewardship course offered by Cyttec[®] Industries. PPQ Officers are **not** required to attend the stewardship courses, but attendance is recommended.

It is a violation of Federal law to use AP, MP, ECO₂FUME[®] and VAPORPH₃OS[®] fumigants in a manner inconsistent with their labeling. These fumigants are **Restricted Use Pesticides** that can only be used by certified applicators. Prior to using the fumigants, submit to PPQ all documentation concerning applicator certification and stewardship program completion by personnel working for the fumigation company. The documentation should be on file and available for periodic audits by the USDA.

A certified applicator **must** be physically present, responsible for, and maintain visual and/or voice contact with all fumigation workers during the application of the fumigants and during the initial opening of the fumigation structure for aeration.

Storage and Handling

Although PH is flammable and can ignite when exposed to excessive moisture, the commercial precautions of AP and MP are considered fire safe and explosion safe when used in accordance with the manufacturer's instruction. Place **no** more than 10 pellets of Phostoxin in a single envelope, which is supplied by the manufacturer. A Fumi-Cel plate should **not** contact another Fumi-Cel plate or the commodity.

Store containers of AP and MP in a cool, dry, locked, ventilated, protected area **not** subject to extremes of temperature. **Never** allow water to come in contact with AP or MP. The shelf life of unopened containers is virtually unlimited. When a tube or container is first opened, the odor of PH (garlic) and ammonia will be noticeable and a blue flame sometimes occurs. However, the quantity of free PH present within that container should **not** be considered dangerous.

When planning a storage area for ECO₂FUME[®] and VAPORPH₃OS[®] cylinders, consider the needs of the local authorities. Provide all emergency response personnel with Material Safety Data Sheets (MSDS) and detailed information regarding the quantities of product stored and the nature and location of the storage area.

Develop an Emergency Response Plan that defines procedures and outlines responsibilities in the event of an accident. Train all site personnel in the plan. Store all cylinders with the valve discharge cap securely in place.

In addition to instructions and precautions found on the label, be certain to:

- ◆ Allow only properly trained personnel to conduct fumigations under the supervision of certified pesticide applicator(s)
- ◆ Always wear safety glasses when handling pressurized equipment
- ◆ Always work in pairs, never alone—a minimum of two people **must** be present during the introduction, sampling, and aeration of the fumigant
- ◆ Comply with all regulations
- ◆ Do **not** apply either PH fumigant in vacuum chambers
- ◆ Ensure that first aid equipment, MSDS sheets, and fumigant labels are readily available at the fumigation site
- ◆ **Never** eat, drink, or smoke when handling PH products
- ◆ Placard the area to be fumigated and an area extending 30 feet from the fumigation enclosure—refer to the fumigation label for appropriate wording on all placards
- ◆ Read and understand sections XI. STORAGE OF CYLINDERS and XII. TRANSPORT in the ECO₂FUME® and VAPORPH₃OS® Application Manual
- ◆ Remove placards when aeration is complete and concentrations are below the TLV
 - ❖ Only certified pesticide applicators or individuals under the direct supervision of the certified applicator should remove placards
- ◆ Study and follow the recommended application procedure
- ◆ Wear dry cloth gloves when handling AP or MP products
- ◆ Wear leather or leather-faced cotton gloves when connecting or disconnecting ECO₂FUME® and VAPORPH₃OS® cylinders from the dispensing or blending equipment
- ◆ Wear steel-toed shoes

First Aid Treatment

Mild inhalation exposure causes:

- ◆ Fatigue
- ◆ Malaise
- ◆ Nausea

- ◆ Pressure in chest
- ◆ Ringing of the ears

Moderate inhalation exposure causes:

- ◆ Chest pain
- ◆ Diarrhea
- ◆ Dyspnea (difficulty breathing)
- ◆ Epigastric pain
- ◆ Vomiting
- ◆ Weakness

Severe inhalation poisoning can occur within a few hours or up to several days—symptoms may be:

- ◆ Cyanosis (blue or purple skin color)
- ◆ Death
- ◆ Dizziness
- ◆ Pulmonary edema (fluid in lungs)
- ◆ Unconsciousness



DANGER

Get the victim to fresh air, treat for shock, and call a physician.

Respiratory Protection

When applying AP, MP, ECO₂FUME[®] and VAPORPH₃OS[®], respiratory protection **must** be available at the site. An adequate number of NIOSH-approved self-contained breathing apparatus (SCBA) with full face piece and operated in pressure-demand mode **must** be available.

The slow evolution of PH from the AP or MP enables the operator to dispense the tablets, pellets, packets, plates, or pre-pack ropes safely, usually **without** the need for wearing an SCBA.

However, wear SCBA during exposure to concentrations in excess of permitted limits (Table 2-11-1) or when concentrations are unknown. If the concentration of phosphine is unknown or known to exceed the STEL's for phosphine and/or carbon dioxide, wear SCBA during troubleshooting for leaks. Use respiratory protection according to local regulations, including regular worker training in using respiratory protection equipment properly,

medical clearance for respirator use, fit testing, inspection, maintenance, and cleaning and storage of respiratory protection equipment.

Table 2-11-1 NIOSH Recommended Respiratory Protection When Applying Phosphine

Phosphine Gas (ppm)	Minimum Respiratory Protection
0.3 - 3.0	Supplied-air respirator
3.1 - 7.5	Supplied-air respirator operated in a continuous-flow mode
7.6 - 15	1. SCBA with full face piece, OR 2. Supplied-air respirator with full face piece, OR 3. Air-purifying full face piece respirator (gas mask) with chin style front or back-mounted canister
16 - 50	1. Supplied-air respirator with a full face piece and operated in pressure-demand mode, OR 2. SCBA with full face piece and operated in pressure-demand mode

MP, AP, ECO₂FUME[®], and VAPORPH₃OS[®]

Packaging

AP and MP are packaged in a variety of ways, depending on the manufacturer. Use [Table 2-11-2](#) to determine the amount of phosphine liberated by each product.

Table 2-11-2 Amount of Phosphine Liberated by Various Products

Product	Type	Unit and Weight in Grams	Grams of Phosphine
Degesch Fumi-Cel [®]	MP	1 plate; 117.0	33.0
Degesch Fumi-Strip [®]	MP	20 plates; 2340.0	660.0
Degesch Phostoxin [®]	AP	1 tablet; 3.0	1.0
Degesch Phostoxin [®] Tablet Prepac Rope	AP	1 prepac; 99.0 (strip or rope of 33 tablets)	33.0
Detia	AP	1 tablet; 3.0	1.0
Detia Rotox AP	AP	1 pellet; 0.6	0.2
Detia Gas EX-B	AP	1 bag or sachet; 34.0	11.4
Fumiphos tablets	AP	1 tablet; 3.0	1.0
Fumiphos pellets	AP	1 pellet; 0.6	0.2
Fumiphos bags	AP	1 bag; 34.0	11.0
Fumitoxin	AP	1 tablet; 3.0	1.0
Fumitoxin	AP	1 pellet; 0.6	0.2
Fumitoxin	AP	1 bag; 34.0	11.0
Gastoxin	AP	1 tablet; 3.0	1.0
Gastoxin	AP	1 pellet; 0.6	0.2
“L” Fume	AP	1 pellet; 0.5	0.18
	AP	1 pellet; 0.6	0.22
Phos-Kill	AP	1 tablet; 3.0	1.1
Phos-Kill	AP	1 pellet; 0.6	0.22
Phos-Kill	AP	1 bag; 34.0	12.0

ECO₂FUME[®] fumigant gas is packaged in a steel compressed gas cylinder designed, manufactured, maintained, and filled in compliance with regulations established by the United States Department of Transportation (DOT). ([Figure 2-11-1](#)). The product flows to the dispensing equipment through the cylinder outlet valve, which is equipped with a “dip tube.” This tube extends to the bottom of the cylinder to facilitate the withdrawal of the liquefied gas mixture. As liquid is withdrawn from the cylinder, some of the product vaporizes to fill the remaining space in the cylinder. Through this vaporization, the cylinder pressure is maintained.

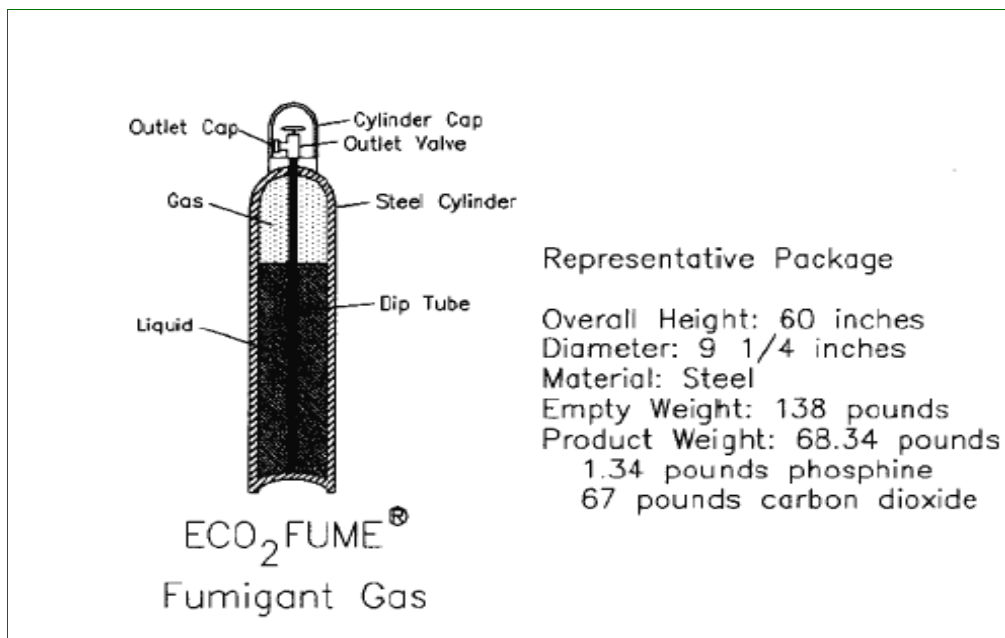

Figure 2-11-1 Diagram of ECO₂FUME[®] Gas Cylinder

The capacity of one ECO₂FUME[®] cylinder at 200 and 500 ppm is 78,000 and 31,100 ft³ respectively. With the volume of ECO₂FUME[®] at 500 ft³ the internal volume of the cylinder is 49 liters. The maximum cylinder pressure is 2,400 psig.

The Compressed Gas Association (CGA) established the valve outlet fitting as a CGA350. The valve outlet is protected by a threaded gas tight outlet cap, which **must** be secured whenever the cylinder is **not** in use. To dispense ECO₂FUME[®] fumigant gas at the time of fumigation, attach only [Cytec[®]](#)-provided (or approved) dispensing equipment to the cylinder valve outlet. Using any other dispensing equipment is prohibited.

Most compressed gas cylinder valves are equipped with a safety device that releases the cylinder contents due to fire exposure or over-pressurization. Because ECO₂FUME[®] and VAPORPH₃OS[®] fumigant gases are poisonous, Hazard Class A, the DOT regulations prohibit using such a device.

Each cylinder is supplied with a cylinder cap designed to protect the outlet valve. Secure this cap whenever a cylinder is **not** in use. It is unlawful to transport an ECO₂FUME[®] or VAPORPH₃OS[®] fumigant gas cylinder **without** the valve outlet cap and the cylinder cap securely in place.

ECO₂FUME[®] and VAPORPH₃OS[®] fumigant gas cylinders can only be refilled by authorized distributors. They can be filled countless times within a 5-year

period. Every 5 years, however, the cylinder is required, by law, to be tested by a qualified facility.

VAPORPH₃OS[®] is packaged in much the same way as ECO₂FUME[®] with two critical exceptions. First, VAPORPH₃OS[®] does **not** contain a dip tube, which means the fumigant is withdrawn from the cylinder directly through the outlet valve. Second, the capacity of one VAPORPH₃OS[®] cylinder at 200 and 500 ppm is 2.25M and 900,000 ft³ respectively. With the volume of VAPORPH₃OS[®] at 500 ft³, the internal volume of the cylinder is 49 liters. The maximum cylinder pressure is 2,400 psig. One VAPORPH₃OS[®] cylinder contains 18,000 grams of phosphine and is capable of fumigating 2.25M ft³.

 **WARNING**

ECO₂FUME[®] cylinders are painted yellow with a dark green shoulder and cap. If you receive a cylinder of a different color or **without** a Cytec[®] ECO₂FUME[®] label, do **not** use the cylinder. Contact your distributor or Cytec[®] with the cylinder serial number.

 **WARNING**

VAPORPH₃OS[®] cylinders are painted silver with a red shoulder. If you receive a cylinder of a different color or **without** a VAPORPH₃OS[®] label, do **not** use the cylinder. Contact your distributor or Cytec[®] with the cylinder serial number.

Dispensing ECO₂FUME[®] Fumigant Gas

The following instructions are intended to provide general guidelines for typical ECO₂FUME[®] fumigation. There are a number of critical factors involved in the design of dispensing equipment (see [Figure 2-11-2](#)). As such, dispensing equipment **must** meet both high-pressure standards and chemical compatibility requirements. Improper or inappropriate use of dispensing equipment can result in severe injury or death. Application inconsistent with the labeling and Application Manual is a violation of Federal law. Buyer assumes all risk should the product be used contrary to label or Application Manual instructions.

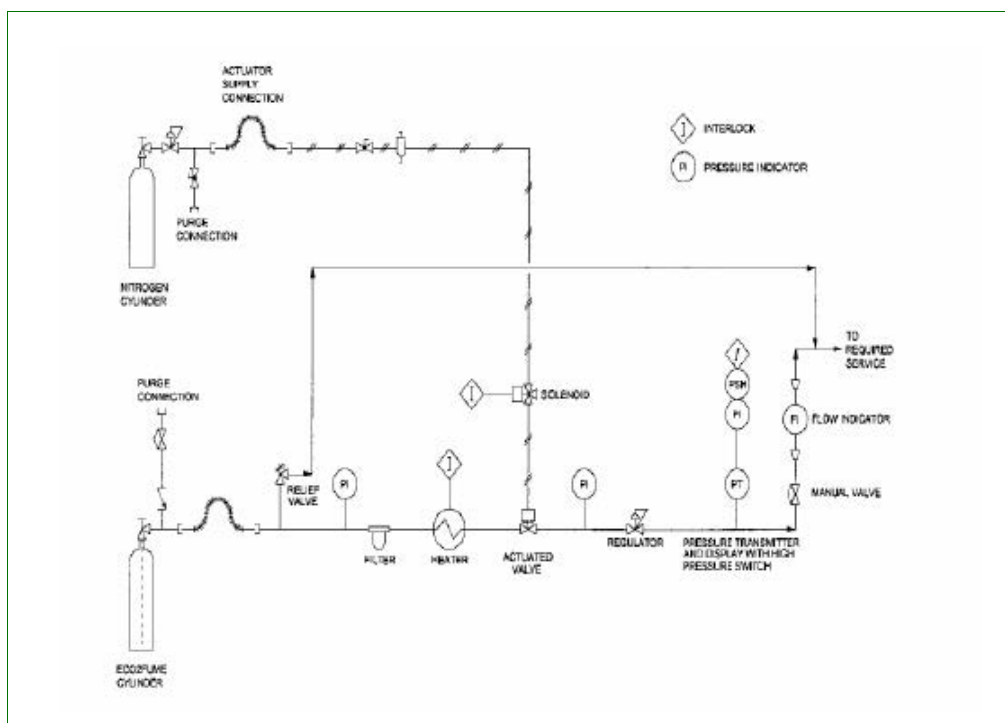

Figure 2-11-2 Diagram of One Type of Dispensing Equipment for ECO₂FUME

Equipment Specification and Use

The equipment used to dispense ECO₂FUME[®] provides a means of containing the gas during the fumigation and controlling the release of the product into the desired space. While some dispensing equipment has been developed and used to date, it cannot be expected to cover all possible fumigation scenarios. The development of suitable dispensing equipment is an ongoing process based on the needs of the users and available technology.

The design of dispensing equipment **must** account for a number of technical issues including pressure rating, material compatibility, temperature limitations, and operator safety. For this reason, only use appropriate equipment when dispensing ECO₂FUME[®]. Only persons trained in the proper use of ECO₂FUME[®] and the dispensing equipment shall be permitted to use ECO₂FUME[®] for fumigation. Consult the instruction materials provided with the dispensing equipment for their proper use and maintenance.

Unapproved Dispensing Methods

It has been common practice with other cylinderized fumigants, to place the cylinder in the space to be fumigated and the cylinder outlet valve opened to allow the fumigant to release. This is **not** an approved dispensing method and should **not** be used with ECO₂FUME[®].

Approved Dispensing Methods

The approved dispensing methods for ECO₂FUME[®] include using pressure-reducing regulators for slow release and selected piping components for quick release. The slow release of ECO₂FUME[®] is generally used for fumigating bulk storage facilities such as silos or bins, or for small fumigation chambers or spaces, and for fumigating stacked materials under tarpaulins. The quick release method is used for space fumigation, or where the commodity to be treated is warehoused. The selection of the dispensing method will depend on the size of the fumigation, the time required, and facility limitations.

Two gas regulators, ambient and heated, have been developed for use with ECO₂FUME[®]. Each of the regulators is designed to reduce the high cylinder pressure (less than 30 psig) and provide the heat necessary to vaporize the fumigant. Once reduced to this lower pressure, the fumigant can be distributed to the desired dispensing points using inexpensive and easy-to-use materials, such as plastic tubing. Flow indicators are used with regulated dispensers to measure and set the dispensing rate.

Ambient Heater Regulated Dispenser. The slower of the two dispensers relies on ambient heat to vaporize the fumigant and is limited to a dispensing rate of about one-half pound of ECO₂FUME[®] per hour.

Heated Regulated Dispenser. The heated regulator uses an external heating vaporizer to provide the energy needed to vaporize the liquid fumigant at a much higher rate than the ambient heat regulator. This regulator is limited to a dispensing rate of about 24 pounds of ECO₂FUME[®] per hour. The equipment is designed for a service pressure up to 3,000 psig. From the cylinder, the liquid mixture flows down a flexible hose or pigtail through a filter and into a heater. The heater is thermostatically controlled and the temperature setting can be adjusted. Exiting the heater, ECO₂FUME[®] gas flows through an actuated valve that can be used for emergency shutdown purposes. ECO₂FUME[®] gas then flows through a gas regulator that drops the pressure to 30 psig. A diaphragm valve is used to control the gas flow at any desired value up to 100 liters/minute as indicated by the flow rotameter. The heater provides 1,000 watts of power that can vaporize a maximum of 100 ppm. Lower rotameter ranges are possible. ECO₂FUME[®] regulator assemblies, equipped with basic features, are available through authorized ECO₂FUME[®] distributors. Multiple regulators may be used together to achieve higher fumigant flows than available through a single regulator and custom equipment can be developed for specific types of applications.

Quick-Release Dispensing Equipment. When the fumigation space is very large, such as a mill, warehouse, or large fumigation chamber, using a number of cylinders is anticipated, a quick means of dispensing ECO₂FUME[®] is available. Specially selected components can be used to direct the cylinder discharge into the fumigation space **without** the need to enter the space during the fumigation. Using this method, a single cylinder can be completely discharged in as little as 15 minutes. Unlike the regulated dispensing methods, the dispensing rate is **not** adjustable and generally, entire cylinders are emptied using this process. If partial cylinder contents are needed, the ECO₂FUME[®] cylinder can be placed on a weight scale and the amount of released fumigant can be measured. The quick release method **must not** be used for fumigation of small-sized stacked materials under tarpaulins, however, the quick dispensing method will be used for most applications. Three techniques of quick dispensing are presented in this section, with the major difference being the tubing size.

1. One technique uses high pressure tubing (stainless steel or hydraulic hose with a nylon core) connected directly to the cylinder valve. The tubing is then routed into the fumigation space. When the cylinder valve is opened the majority of the liquid will be dispensed in 4 to 5 minutes. The last few pounds below the cylinder internal dip pipe will require several additional minutes to vaporize and be dispensed. When the cylinder is empty of liquid, approximately 18 pounds of gas will remain in the cylinder. For larger fumigations, manifolds may be used with the cylinders to make the dispensing faster. Always leak test the dispensing piping and cylinder connection before opening the cylinder valve.
2. When a slower dispensing rate is desired, use smaller tubing (stainless steel or hydraulic hose with a nylon core). The fumigator **must not** throttle the cylinder valve to slow the dispensing rate; to do so will cause a high pressure drop through the valve. The pressure drop will result in cooling and dry ice formation. This solid dry ice formation will plug the dispensing pipe and possibly the cylinder valve. Attaching a short section of 1/8 inch tubing to the end of the 1/4 inch tubing will slow the dispensing rate to approximately 5 pounds per minute. Use a calibrated scale to ensure the proper amount of product dispensed.
3. If a dispensing rate of less than 5 pounds per minute is required, a small section of 1/16 inch tubing, 0.04 inch internal diameter (stainless steel or hydraulic hose with a nylon core) can be attached to the end of the 1/4 inch tubing to slow the dispensing rate to approximately 1.6 pounds per minute. Use a scale to ensure the proper amount of product is dispensed. The tubing is also available in smaller internal diameters (I.D.) for reduced dispensing rates. When 1/8 inch tubing or 1/16 inch tubing is used, a filter is recommended to prevent plugging of the smaller tubing.

Blending VAPORPH₃OS[®] Fumigant Gas

The following instructions are intended to provide general guidelines for typical fumigations. There are a number of critical factors involved in the design of blending equipment. As such, blending equipment **must** meet both high-pressure standards and chemical compatibility requirements. Improper or inappropriate use of blending equipment may result in severe injury or death. Application inconsistent with the labeling and Application Manual is a violation of Federal law. Buyer assumes all risk should the product be used contrary to label or Application Manual instructions.

Equipment Specification and Use

The equipment used to blend VAPORPH₃OS[®] on site with carbon dioxide or surrounding air into a nonflammable gas mixture provides a means of containing the gas during the application and controlling the release of the product into the desired space. While some blending equipment has been developed and used to date, they **cannot** be expected to cover all possible fumigation scenarios. The development of suitable blending equipment is an ongoing process based on the needs of the users and available technology.

Blending equipment design **must** account for a number of technical issues including pressure rating, material compatibility, temperature limitations and operator safety, and controlling the phosphine concentration between 2.0 and 2.9 percent volume for carbon dioxide blending, and less than 10,000 ppm (1 percent volume) for dilution with air. For this reason, use only [Cytex[®]](#)-approved equipment in VAPORPH₃OS[®] blending. Only persons trained in the proper use of VAPORPH₃OS[®] and the dispensing equipment shall be permitted to use VAPORPH₃OS[®] for fumigation. These persons **must** also be licensed pesticide applicators.

Consult the instruction materials provided with the blending equipment or dilution equipment for their proper use and maintenance. FOSFOQUIM, the authorized manufacturer of the phosphine air blending equipment, will provide training and written instructions for the use and maintenance of its HDS equipment.

Unapproved Dispensing Methods

It has been common practice with other cylinderized fumigants to place the cylinder in the space to be fumigated and the cylinder outlet valve opened to allow the fumigant to release. This is **not** an approved dispensing method and should **not** be used with VAPORPH₃OS[®]. VAPORPH₃OS[®] phosphine fumigant is pyrophoric and will spontaneously ignite in air. VAPORPH₃OS[®] **must** be properly blended with carbon dioxide or diluted with air to eliminate the flammability hazard.

Blending Equipment for VAPORPH₃OS[®] and Carbon Dioxide

Phosphine gas (VAPORPH₃OS[®]) from high-pressure cylinders flows into the blender unit where it combines with carbon dioxide gas sourced from bulk storage, mobile bulk truck, semibulk, or cylinders. Various models of on-site blending equipment have been designed, built, and tested. All of the designs have incorporated engineering safeguards to ensure that the blended product is a nonflammable mixture.

One design uses a pressure regulator and flow control orifice on both the VAPORPH₃OS[®] and carbon dioxide gases to control the flow rate and to properly blend VAPORPH₃OS[®] with carbon dioxide. The size of each orifice is engineered for a specific fixed flow rate and, therefore, the blending rate **cannot** be adjusted. By controlling the pressure drop across the orifice plates, the phosphine concentration can be controlled around 2.5 percent v/v.

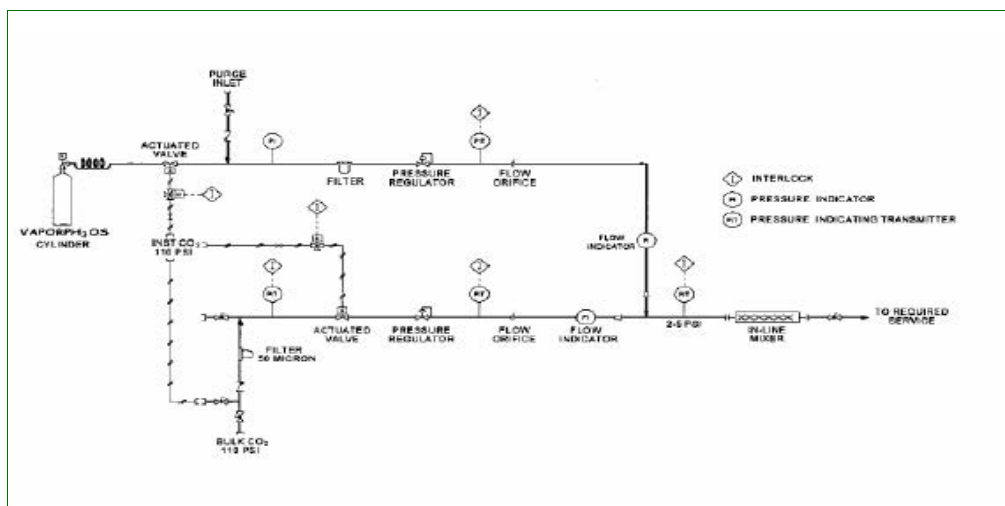

Figure 2-11-3 Diagram of One Type of Blending Equipment for VAPORPH₃OS

A more sophisticated design uses mass meters, control valves, and the electronics to allow an adjustable blending rate while maintaining the proper blend of phosphine concentration from going outside the range of 2.0 to 2.9 percent volume (1.6 to 2.2 percent weight). The product from this equipment is equivalent to ECO₂FUME[®] fumigant gas. Blending equipment is intended for large facilities that have on-site carbon dioxide bulk storage and vaporizing equipment or facilities where it is feasible to bring in bulk carbon dioxide and vaporizing equipment for the fumigation. The blending equipment is designed for use only with carbon dioxide gas; therefore, a bulk supply of liquid carbon dioxide **must** be equipped with suitable vaporizing equipment. Contact [Cytec[®]](#) for blending equipment design specifications and recommendations. For smaller fumigation jobs, it is recommended that preblended ECO₂FUME[®] cylinders be used. VAPORPH₃OS[®] fumigant gas can only be blended with

registered carbon dioxide products. **Never** allow the buildup of phosphine to exceed explosive concentrations. When phosphine is blended with carbon dioxide, the LFL is raised to 3 percent v/v. The fumigator should always check with [Cytec[®]](#) for approved blending equipment. Fumigators should provide PPQ with all [Cytec[®]](#) equipment authorization documentation. The documentation should be on file and available for periodic audits by the USDA.

Blending Equipment for VAPORPH₃OS[®] and Forced Air

Phosphine gas (VAPORPH₃OS[®]) can spontaneously ignite in air if the concentration is greater than 1.8 percent (18,000 ppm). With specialized equipment, pure phosphine can be safely blended with a forced air stream to ensure the final concentration does **not** exceed 10,000 ppm (55 percent of the Lower Flammability Limit of 18,000 ppm). The equipment has incorporated engineering safeguards to ensure the flammable concentration is **never** exceeded.

Various models of phosphine/forced air blending equipment have been designed, built, and tested. The Horn Diluphos System (HDS) from FOSFOQUIM is approved by [Cytec[®]](#) and the [USDA-APHIS-PPQ-S&T-TMT](#) to blend VAPORPH₃OS[®] with forced air (see section on HDS80 and HDS200 Blending Equipment). One design uses inert gas (nitrogen or carbon dioxide) to prepurge the phosphine lines and equipment. Once purged, phosphine flows through a pressure regulator and flow controller to the mixing point. Here, phosphine is safely blended into the forced air stream. The forced air can be supplied by various fans, blowers, or compressors. The air flow is measured and the phosphine flow will stop if the air flow is insufficient.

If the phosphine flow is stopped for any reason, post-purging of the phosphine lines and equipment is automatic.

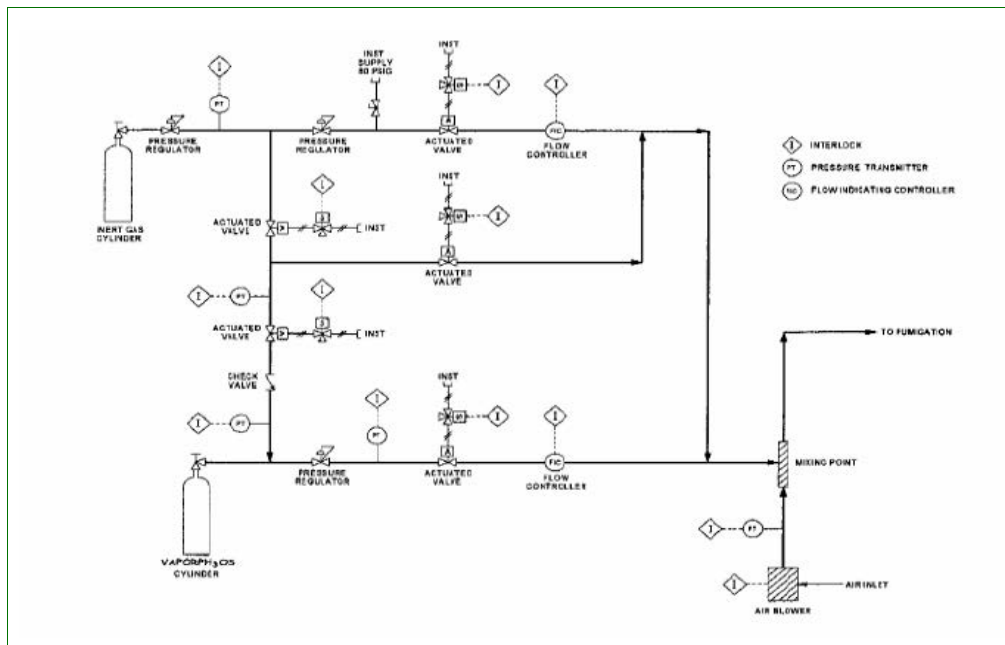

Figure 2-11-4 Diagram of VAPORPH₃OS[®] and Forced Air Blending Equipment

Dosage

The dosage rate for AP, MP, ECO₂FUME[®] and VAPORPH₃OS[®] is measured in grams per 1,000 cubic feet or grams per cubic meter and varies with the commodity, treatment temperature, and type of enclosure. The initial fumigant dose is determined by the volume of the space to be fumigated and the required phosphine dose rate needed to kill the target pest. ECO₂FUME[®] and VAPORPH₃OS[®] fumigant gas and carbon dioxide/forced air can be added if the desired target concentration changes due to a loss of the fumigant through leaks in the fumigation enclosure.

AP and MP

To calculate the number of tablets or pellets of AP or MP required for the fumigation:

Dosage Rate = the dosage rate from the treatment schedule (grams)

Volume of enclosure = Length x Width x Height (ft³)

Grams of phosphine liberated = [Table 2-11-2](#)

Step 1: Grams of PH₃ = (Dosage Rate x Volume of enclosure)/1,000 ft³

Step 2: Number of Tablets or Pellets needed = grams of PH₃/grams of phosphine liberated

EXAMPLE T308-b-2. Tobacco for Export in a warehouse requires 20 grams of phosphine per 1,000 ft³. The size of the warehouse is 100' x 75' x 50'. To determine the number of Fumiphos tablets and pellets to introduce, use the following procedure:

$$100' \times 75' \times 50' = 375,000 \text{ ft}^3$$

Step 1: $(20 \text{ g} \times 375,000 \text{ ft}^3) / 1,000 \text{ ft}^3 = 7,500 \text{ g}$

Step 2:

Tablets: $7,500 / 1.0 = 7,500 \text{ tablets}$

Pellets: $7,500 / 0.2 = 37,500 \text{ pellets}$

ECO₂FUME[®]

Method 1:

◆ **1 gram of phosphine (PH₃) = 25 ppm PH₃/1,000 ft³**

To calculate the total amount of ECO₂FUME[®] required for each treatment:

◆ **Target concentration in ppm = (Dosage rate in grams from Treatment Schedule x 25 ppm)**

◆ **Grams of PH₃ = (Target concentration x Volume of enclosure)/25,000**

◆ **Pounds of ECO₂FUME[®] = (Target concentration x Volume)/226,800**

EXAMPLE T301-d-1-2 Cotton and cotton products requires 36 g of phosphine per 1,000 ft³. The volume of this enclosure is 10' x 10' x 10'. To determine the pounds of ECO₂FUME[®] follow these steps:

Step 1: Convert grams of phosphine to ppm:

$$36 \text{ g} \times 25 = 900 \text{ ppm} / 1,000 \text{ ft}^3$$

Step 2: Determine total volume of the enclosure

$$10' \times 10' \times 10' = 1,000 \text{ ft}^3$$

Step 3: Apply the formula to determine the amount of ECO₂FUME[®] to introduce $(900 \text{ ppm} \times 1,000 \text{ ft}^3) / 226,800 = 3.97 \text{ pounds}$

Therefore, 3.97 pounds of ECO₂FUME[®] will be introduced into the structure.

Method 2:

◆ **1 pound of ECO₂FUME[®] = 9.07 grams PH₃**

◆ Divide the dosage rate from the treatment schedule (in grams) by 9.07

EXAMPLE Assuming the same Treatment Schedule as the previous example (T301-d-1-2 Cotton and cotton products):

$$36 / 9.07 = 3.97 \text{ pounds}$$

NOTICE

When the amount of gas introduced is less than 68 pounds, use a calibrated scale to determine when the proper amount of gas has been introduced into the space.

VAPORPH₃OS[®]

To calculate the amount of VAPORPH₃OS[®] required for the fumigation:

◆ **1 pound of VAPORPH₃OS[®] = 454 grams PH₃**

Target concentration = the desired phosphine concentration (ppm) from the treatment schedule

Step 1: Grams of PH₃ = (Target concentration x Volume of enclosure)/25,000

Blending with CO₂. Once the amount of phosphine has been determined, the appropriate amount of carbon dioxide **must** be calculated. It is recommended that twice the amount of carbon dioxide be available to ensure an adequate supply for the initial dose, the addition of gas, and equipment purging.

To calculate the amount of carbon dioxide required for the fumigation:

Step 2: Pounds of CO₂ = (Grams of PH₃/454) x 105.3

EXAMPLE T301-d-1-2 Cotton and cotton products requires 36 g of phosphine per 1,000 ft³. The volume of the enclosure is 75,000 ft³. To determine the amount of VAPORPH₃OS[®] gas to introduce, follow these steps:

Step 1: $(36 \text{ g} \times 25 \times 75,000 \text{ ft}^3) / 25,000 = 2,700 \text{ grams PH}_3$

Step 2: $(2,700 / 454) \times 105.3 = 626 \text{ pounds CO}_2$

Blending with Forced Air. When blending with forced air, only the amount of phosphine needs to be calculated. A closed circulation system is created if the air supply is sourced from inside the fumigation enclosure. This will prevent a positive pressure from developing within the fumigation space. If recirculation is **not** used, the perimeter of the fumigation site will need to be monitored because the air will be displaced from the fumigation space. The HDS 80 blending equipment used with forced air dispenses at 50g/min. If the minimum air flow is **not** maintained, the blending equipment will automatically shut down and phosphine will **no** longer be dispensed.

Adding ECO₂FUME[®] and VAPORPH₃OS[®] Gas to an Enclosure

Depending on the sealability of the type of space to be fumigated, it may be necessary to add additional gas to the structure in order to maintain the target concentration required by the treatment schedule.

To calculate the amount of ECO₂FUME[®]/VAPORPH₃OS[®] to be added:

$$\text{Grams of PH}_3 = (\text{Target Concentration} - \text{Actual Concentration}) \times \text{Volume} / 25,000$$

The target and actual concentrations are measured in ppm and **must** be monitored with a device approved by S&T-TMT.

Preparing to Fumigate Break Bulk Cargo

Break bulk cargo has been unloaded from a ship hold, a container, or rail car. This cargo can be fumigated by covering the pallets, boxes, or raw cargo with an impervious tarpaulin.

Always check this manual to determine if there is an approved treatment schedule using either AP, MP, ECO₂FUME[®] or VAPORPH₃OS[®] fumigant for the infested commodity. Treatment schedules typically list the commodity to fumigate with its associated pest(s). If the commodity in question does **not** have a treatment schedule, contact the [USDA-APHIS-PPQ-S&T-TMT](#) to determine if there is an alternative treatment available.

Step 1: Site Selection

Consider the following factors when selecting a fumigation site:

- ◆ Ability to heat (in colder areas)
- ◆ Aeration requirements
- ◆ Electrical power supply
- ◆ Impervious surface
- ◆ Nonwork area that can be effectively marked and safeguarded or isolated
- ◆ Water supply
- ◆ Well-lighted area
- ◆ Well-ventilated, sheltered area

Ability to Heat Area

When cool temperatures (below 40 °F) are expected, heat the site to maintain commodity temperatures above 40 °F; take the ambient temperature 12 inches above the floor.

The temperature of the enclosure must be monitored using a temperature recording system, consisting of temperature sensors and a data recorder. The temperature recording system must meet the following specifications:

- ◆ Accurate to within ± 0.6 °C or ± 1.0 °F in the treatment temperature range of 4.4 °C to 26.7 °C (40 °F to 80 °F)
- ◆ Calibrated annually by the National Institute of Standards and Technology (NIST) or by the manufacturer
 - ❖ The calibration certificate will list a correction factor, if needed, and the correction factor would be applied to the actual temperature reading to obtain the true temperature.
- ◆ Capable of printing all temperature readings or downloading data to a secure source once per hour throughout the entire treatment (all temperature data must be accessible at a safe distance during the fumigation)
- ◆ Tamper-proof

If one or more of the temperature readings go below 40 °F the fumigation will be considered a failed treatment. The commodity must be re-treated, returned to the country of origin, reexported, or destroyed.

Place temperature sensors evenly throughout the enclosure. The placement of the sensors will vary depending on the item fumigated and the configuration of the fumigation site. Contact [USDA-APHIS-PPQ-S&T-TMT](#) for instructions regarding the exact placement of the temperature sensors.

- ◆ Because phosphoric acid will be produced if phosphine is burned, never use flame or exposed electrical element heaters during treatment.
 - ❖ Contact [USDA-APHIS-PPQ-S&T-TMT](#) for appropriate heating sources.

An Impervious Surface

Select an asphalt, concrete, or tight wooden surface, not soil or gravel, or other porous surfaces. If you must fumigate on a porous surface, cover the surface with plastic tarpaulins.

For large fumigations, covering the surface is **not** usually practical because pallets **must** be rearranged and heavy equipment used to move the commodity.

On docks, wharfs, and piers, check for cracks, holes, and manhole covers that will allow the phosphine gas to escape through the floor.

Seal all cracks, holes, and manhole covers with plastic tarpaulins.

A Nonwork Area

Select a secure nonwork area where traffic and people are restricted from entering.

- ◆ The fumigation area is considered either the entire structure area or an area that extends 30 feet from the tarpaulin and is separated by a physical barrier, such as ropes, barricades, or walls. Place placards clearly in sight of all who come near.
- ◆ If a wall of gas-impervious material is less than 30 feet from the tarpaulin, the wall may serve as the edge of the secured area.
- ◆ Additional guidelines may be required by some state's Department of Agriculture. Some states (California, for example) require a 100-foot buffer zone.
- ◆ Place placards clearly in sight of all who come near
 - ❖ Placards **must** meet label requirements regarding specific warnings, information, and language.
 - ❖ Placards generally include the name of the fumigant, the fumigation date, time, and the name of the company conducting the fumigation.
 - ❖ Restrict access to the fumigation area to the fumigator's employees and PPQ employees monitoring the treatment.
 - ❖ Use rope or marker tape to limit access within 30 feet of the enclosure.
 - ❖ Do **not** allow motor vehicles (including forklifts) to operate within 30 feet of the enclosure during fumigation and aeration periods.
 - ❖ The area outside the 30-foot perimeter is usually regarded as a safe distance from the tarpaulin.
 - ❖ The 30-foot perimeter is **not** specifically mentioned on the AP, MP, ECO₂FUME[®] and VAPORPH₃OS[®] labels, but is required for safety to PPQ Officers.

NOTICE

Gas concentrations should **never** exceed 0.3 ppm phosphine and 5,000 ppm carbon dioxide in the safety zone (30 feet from the enclosure where officers are taking gas concentration readings).

Use colorimetric tubes or other approved devices to measure gas concentrations.

Electrical Power Supply

An adequate electrical source must be available to run the dispensing equipment (ECO₂FUME[®] and VAPORPH₃OS[®] only).

- ◆ A separate line should be available for the dispensing and blending units.

- ◆ Electrical outlets **must** be grounded and conveniently located in relation to the fumigation area.
- ◆ **Except** under emergency conditions, do **not** use generators as a power source.

Water Supply

A water supply is necessary for safety purposes; if no permanent water source is present on site, the fumigator must provide a portable, 5-gallon supply of clean water.

Well-Lighted Area

The area should have adequate lighting for safety purposes and for ease in reading the gas monitoring devices, thermometers, and for determining whether a tarpaulin has holes or tears.

Well-ventilated, Sheltered Area

Select sites that are well-ventilated and in a sheltered area. A well-ventilated site is required for exhausting gas before and when the tarpaulin is removed from the stack.

If fumigations are conducted outside, select a site that is semisheltered such as the leeward side of a warehouse, pier, or building that offers some protection from strong winds.

Step 2: Arranging the Stack

- ◆ Arrange the cargo in a square or rectangular shape, if possible, to make it easy to cover and to calculate the volume of the stack.
 - ❖ An even-shaped stack is easier to tarp.
 - ❖ By arranging the stack evenly and with space between pallets or cartons, the fumigant will be effectively distributed.
 - ❖ The height of the stack should be uniform so dosage can be calculated accurately.
- ◆ The maximum size for an enclosure is 25,000 ft³
 - ❖ Contact the [USDA-APHIS-PPQ-S&T-TMT](#) to get approval for any enclosures larger than 25,000 ft³
 - ❖ For very large enclosures, it may be necessary to add more sampling leads or introduce the fumigant at several sites.

- ◆ When the fumigation involves multiple stacks, allow 10 feet of space between each uncovered stack; after the stack is tarped, there should be approximately 5 feet between enclosures.

Step 3: Padding the Corners

Examine all areas that typically tear tarpaulins, e.g., corners and sharp angles. If the sharp angles or corners **cannot** be eliminated, they **must** be covered with burlap or other suitable padding (e.g., old tires or cloth).

Step 4: Covering the Stack

After covering the stack, check the tarpaulin for rips, tears, and holes. Look at the taped areas and verify they are properly sealed. Have the fumigator repair all holes.

The tarpaulin **must** be made of a tough material such as vinyl, polyethylene plastic, or coated nylon. The tarpaulins should be a minimum of 2-mil thickness; however, it is recommended to use 6 mil tarpaulins whenever possible.

The tarpaulin **must** be large enough to provide a floor overlap of at least 18 inches around all sides of the stack. Carefully lay the tarpaulin out to prevent excess folds or wrinkles along the floor, especially around corners.

Step 5: Sealing the Tarp

The goal in sealing the tarpaulin is to get it to lay flat against the floor to prevent gas from leaking out. Seal the tarpaulin with loose, wet sand, sand snakes, water snakes, adhesives, or a combination. If there is danger of crushing or crimping the gas sampling or introduction tubes, use the loose, wet sand. If using snakes, use two rows of snakes along the sides and three rows on the corners. The snakes should overlap each other by approximately 1 foot. Seal corners by laying two sand snakes around the corner and working the tarpaulin until it is flat. To force the tarpaulin against the floor, place a third snake on top of the two other snakes to provide additional weight. Loose, wet sand can be used in the area where the gas introduction line, electrical cords, and gas sampling tubes extend from under the tarpaulin.

Step 6: Introducing the Gas

Depending upon the type of AP or MP formulation used, the gas may be dispensed in a variety of methods. Follow the application procedures from the manufacturer's label for detailed instructions on gas introduction.

For ECO₂FUME[®] and VAPORPH₃OS[®], install the gas introduction line(s) at ground level on the floor or secured onto a pallet. These lines should **not** be located in or attached to commodity package and should be secured to eliminate the movement of the line(s). Direct the discharge toward the center of the space being treated and away from equipment, if possible. For tarpaulin

enclosures, control the dispensing rate of the gas. The tarpaulin can become damaged and sealing undone if the fumigant is dispensed at high speeds. For small enclosures, a cylinder pressure less than 100 psig is recommended. A regulated dispenser with a pressure regulator and flow restricting nozzles are options to control the rate of the fumigant.

Place the fumigant cylinder with gas introduction line on a calibrated scale and take an initial weight reading. Ensure the gas introduction line is attached to the cylinder. After obtaining the correct weight, subtract the dosage to be introduced into the enclosure. After introducing the proper amount of gas, the scale will be balanced.

When **no** further fumigant is required to maintain target concentration levels, close all cylinder valves, depressurize the dispensing equipment, and disconnect all ECO₂FUME[®] or VAPORPH₃OS[®] cylinders. Replace the cylinder cap after the valve discharge cap is securely installed.

Step 7: Placing the Gas Sampling Tubes

Place a minimum of three gas sampling tubes for fumigations up to 10,000 ft³. Position the gas sampling tubes in the following locations:

- ◆ Front—low and front of the load, 3 inches above the floor
- ◆ Middle—center of the load (inside the box with the commodity), midway from bottom to top of load
- ◆ Rear—high and rear of the load, at the extreme top of the load

For fumigations from 10,001 to 25,000 ft³, use six gas sampling tubes. Position the gas sampling tubes in the following locations:

- ◆ Front—low and front of the load, 3 inches above the floor
- ◆ Lower rear quarter section (inside the box with the commodity)
- ◆ Middle—center of the stack (inside the box with the commodity), midway from bottom to top
- ◆ Rear—high and rear of the stack, at the extreme top of the load
- ◆ Upper front quarter section (inside the box with the commodity)
- ◆ Upper rear quarter section

For approval of fumigations larger than 25,000 ft³, contact the [USDA-APHIS-PPQ-S&T-TMT](#) for instructions regarding the number of gas sampling tubes, and for other technical information.

Before inserting into the commodity, cover the end of the gas sampling tubes with burlap or wire gauze taped to the tube.

Use gas sampling tubes of sufficient length to extend from the sampling position inside the enclosure to at least 30 feet beyond the tarpaulin. Connect all the gas sampling tubes in one area for ease and safety in recording gas concentration readings. Do **not** splice gas sampling tubes. Fix all gas sampling tubes securely in place under the tarpaulin and label each one where the gas concentration readings will be recorded. By labeling each gas sampling tube, concentration readings can be easily recorded.

Step 8: Testing for Leaks

To ensure they are within acceptable levels outside the fumigation area, monitor phosphine and carbon dioxide levels at the fumigation site and 30 feet from the fumigation enclosure. Phosphine and carbon dioxide levels can be detected using chemical-specific colorimetric tubes or electronic monitors, e.g., Draeger and PortaSens detection kits. Do **not** use a Gow-Mac or Fumiscope to record gas readings.

The fumigator should leak test all connections and fittings before opening the cylinder valve. Instructions concerning cylinder leak detection can be found under the section “Poison Gas Hazards—Leak Detection and Repair” of the ECO₂FUME[®] and VAPORPH₃OS[®] fumigant Application Manuals.

Step 9: Monitoring Gas Concentrations

Take concentration readings within the enclosure using sampling lines connected to an APHIS-approved phosphine monitoring device. The fumigation does **not** begin until all of the gas has been introduced. Monitoring **must** take place 30 feet or more from the enclosure.

Phosphine and carbon dioxide levels can be detected using chemical-specific colorimetric tubes or approved electronic monitors, e.g., Draeger and PortaSens detection kits. To determine if additional gas is needed, check gas concentration levels 30 minutes after the fumigant is added and periodically throughout the fumigation. Record gas concentration readings on PPQ Form 429A and in the electronic 429 database at the time intervals prescribed by the treatment schedule in this manual.

The 30-minute reading shows the initial concentration and distribution of gas and can indicate leakage, incorrect dosage calculation, or error in fumigant introduction.

If the desired phosphine concentration is met before all of the gas is introduced, stop the addition of ECO₂FUME[®] or VAPORPH₃OS[®] and check all calculations. When fumigating with ECO₂FUME[®], 200 ppm of phosphine will release 7,700 ppm of carbon dioxide.

NOTICE

Erroneous readings can occur if the monitoring leads become blocked or crimped. It would be impossible to install a new monitoring lead during a fumigation treatment; therefore, always test monitoring leads before the treatment begins.

In order to detect blocked monitoring leads, follow the procedure below using a Mityvac[®] hand-held pump (for supplier, See [Vacuum Pump](#) on page E-1-54.)

1. Prior to fumigant introduction, connect the Mityvac[®] hand-held vacuum pump to a monitoring lead.
2. Squeeze the handle on the Mityvac[®] unit. If the lead is blocked, a vacuum will be indicated on the vacuum gauge of the Mityvac[®] unit. For monitoring leads longer than 25 feet, squeeze the handle two or three times. The Mityvac[®] hand-held pump has the capacity to attain and hold 25 inches of Hg vacuum and a minimum of 7 psig pressure.
3. Disconnect the Mityvac[®] hand-held pump from the monitoring lead, and repeat this procedure for each monitoring lead. Connect monitoring leads to the gas analyzer prior to fumigant introduction.

Preparing to Fumigate Containerized Cargo

Containers require small amounts of phosphine. Therefore, AP, MP, or ECO₂FUME[®] fumigant gas (**not** VAPORPH₃OS[®]) is recommended for all container fumigations for which an approved treatment exists.

PPQ **does allow** the fumigation of nontarped containers provided the container can be completely sealed in order to prevent gas loss.

To fumigate containerized cargo, follow Steps 1 through 9 in the previous section, [Preparing to Fumigate Break Bulk Cargo](#) on page 2-11-21.

Additional Considerations for Fumigating Containerized Cargo

If fumigating a **nontarped** container:

- ◆ Close and secure one of the doors
 - ❖ If possible, caulk all joints and drape entire doorway with polyethylene sheeting, securing the edges to the inner walls, floor, and ceiling with duct tape
 - ❖ Seal all openings and joints
- ◆ Inspect the roof, floor, and walls for holes and cracks
 - ❖ Containers require close inspection and a great deal of sealing to prevent fumigant leakage
 - ❖ Seal all openings with either duct tape or caulking compound
- ◆ If possible, drape remaining doorway with polyethylene sheeting before the door is closed
 - ❖ Close door and secure

- ❖ If doorway is draped with polyethylene, it may **not** be necessary to seal the door from the outside
- ❖ If doorway is **not** draped, seal all cracks, openings, and joints with masking tape and caulking compound from the outside
- ❖ Secure edges to door jams and floor
- ◆ Placard all doors of the container with the appropriate warnings before fumigation begins

If fumigating a tarped container:

- ◆ If unable to completely seal the container, use a tarpaulin to cover the entire container
- ◆ Use a 4, 6, 10, or 12 mil vinyl, polyethylene plastic, or coated nylon tarpaulin
- ◆ After covering the container with a tarpaulin, check for rips, tears, and holes
 - ❖ Examine all taped areas and verify they are properly sealed
 - ❖ Have the fumigator repair all holes
- ◆ The tarpaulin **must** be large enough to provide a floor overlap of at least 18 inches around all sides of the container—carefully lay the tarpaulin out to prevent excess folds or wrinkles along the floor, especially around corners

Preparing to Fumigate Bulk Commodities

AP, MP, ECO₂FUME[®] and VAPORPH₃OS[®] can be used to fumigate any type of bulk commodity storage for which there is an approved treatment in this manual. These include, but are **not** limited to, bins, tanks, flat storage, and bunkers. The most important aspects of a successful fumigation, as with any fumigant, are the degree to which the space is sealed and the assurance that the minimum fumigant concentrations are maintained for the required time.

To fumigate bulk commodities, use the procedures outlined in the section, [Preparing to Fumigate Break Bulk Cargo](#) on page 2-11-21.

Probing

AP and MP Fumigation

When treating large quantities of grain or other bulk commodities, it will be necessary to “probe” tablets or pellets into the mass of the commodity for adequate distribution. Specially constructed probes made of steel tubing one and one-quarter inch in diameter are generally available as described below:

- ◆ Head Piece—Dosing device and numerical counter to indicate number of tablets used
- ◆ Tubing—Usually in 3-foot sections that can be added to one another to provide the desired length
- ◆ End Piece—Cut obliquely and provided with a hinged flap, closing the entrance to the tube
 - ❖ When the tube is inserted into the commodity, the flap is closed and prevents the commodity from entering
 - ❖ When the probe is withdrawn, the flap opens due to the slightly larger diameter on the flap
 - ⇒ The tablets or pellets are then released one at a time as the probe is withdrawn

Grain or other bulk or loose commodities up to 30 feet deep can be probed. Best results are obtained by probing twice every square foot and as regularly as possible. Penetration of phosphine is up to 10 feet below the area in which the tablets are placed. When large bulk grain stores are treated, many probes can be placed prior to treatment. One head piece can be moved from probe to probe, or pellets or tablets can be placed in the tubes by hand (use surgical or disposable thin rubber or polyethylene gloves).

Gas generation starts within 4 hours of placing the pellets or tablets (depending on relative humidity). Therefore, the whole procedure of pellet or tablet placement or tarpaulin covering **must** be accomplished within this time frame. It is possible to work in a probed area if the area is covered with a gas-proof tarpaulin. Monitor gas concentrations to determine if toxic levels are approached and take corrective action to prevent exposure.

Additional Considerations for Fumigating Bulk Commodities

- ◆ Based on the size of the structure being fumigated, refer to the ECO₂FUME[®] and VAPORPH₃OS[®] Application Manuals for acceptable dispensing equipment
- ◆ For large storage facilities, (>25,000 ft³), consider multiple dispensing points to assist in fumigant distribution

- ❖ Contact the [USDA-APHIS-PPQ-S&T-TMT](#) for a determination on the number of sampling lines for large fumigations
- ◆ If a bulk consignment is in a large storage facility with a high roof, it may be better to tarp on top of the grain, rather than seal the roof
 - ❖ When side walls of the facility are **not** gas impervious, place tarpaulins (minimum 6 mm thickness) around the outside of the facility to the height of the commodity
- ◆ If it is known ahead of time that grain or cottonseed will require treatment prior to placement in a means of conveyance or storage, properly seal the space before loading. Use tarpaulins of at least 6 mm thickness if walls are permeable since lighter tarpaulins may tear.

Aeration Requirements

Break Bulk, Containers, and Bulk Fumigations

Following completion of treatment, aerate phosphine-treated commodities using either electric exhaust fans or by passive aeration in the open air. Personnel are **not** allowed to enter or reenter fumigated areas until gas concentrations are determined to be below the Threshold Limit Values (TLV) for phosphine and carbon dioxide. Check ambient air and the air inside the box, carton, bin, etc., of the commodity during aeration. Measure gas concentration levels with a sensitive gas detection device. Aerate all commodities to acceptable tolerance levels ([Table 2-11-3](#)). Because they can continue to release gas after the initial gas levels have dropped to acceptable levels, continue to monitor densely packed commodities. A certified applicator **must** be physically present, responsible for, and maintain visual and/or voice contact with all fumigation workers during the initial opening of the fumigation structure for aeration. Always follow the aeration instructions provided with the fumigant label.

Table 2-11-3 Phosphine Residue Tolerances

Commodity	Tolerance of Phosphine Residues (ppm)	Minimum Aeration Period (hours)
Animal feeds, grains, nuts, and dates	0.1	48
Processed foods	0.01	48
Fresh fruits and vegetables	0.01	48
Nonfood commodities	<0.3	None
Tobacco	<0.3	48

Disposal of AP and MP Residue

Following treatment with AP, a powdery residue, essentially aluminum hydroxide, will remain. Collect this material and mix it in a container of water to which liquid detergent has been added (2 tablespoons of detergent per gallon of water). Bury or deposit the liquid in an approved pesticide disposal landfill.

Following treatment with MP, dispose of the plates by burial in an approved landfill or by burning where approved by local ordinances.

Follow the manufacturer's label instructions for detailed disposal guidelines.

Contacts

Cytec®

Cytec Industries, Inc.
5 Garret Mountain Plaza
West Patterson, NJ 07242
Phone: (973) 357-3100
email: custinfo@cytec.com

USDA-APHIS-PPQ-S&T-TMT

13601 Old Cutler Road, Bldg. 63
Miami, FL 33158 USA
Phone: 305-278-4877
Fax: 305-278-4898
email: ppqmt@usda.gov

Chemical Treatments

Aerosols

Contents

Introduction	2-12-1
10% d-phenothrin	2-12-1
Passenger Compartment Application	2-12-2
Treating Baggage/Cargo Holds	2-12-4
Precautions for Aircraft Transiting Airports at High-Risk for Japanese Beetles	2-12-6
2% d-phenothrin + 2% permethrin	2-12-6
Ordering Information	2-12-8
10% d-phenothrin	2-12-8
2% d-phenothrin + 2% permethrin	2-12-8
Precautions	2-12-8

Introduction

The information in this section provides CBP and PPQ officials and commercial applicators the procedures and precautions for applying aerosol insecticides in aircraft.

PPQ uses aerosol insecticides to treat for Japanese beetle, Khapra beetle, and other hitchhiking pests. Respirators are recommended but not required by the chemical labels.

WARNING

Do not subject these chemicals to extreme temperatures.

There are currently two aerosols approved for use in aircraft passenger areas, aircraft cargo holds, and aircraft pods, Callington 1-Shot™ (2% d-phenothrin + 2% permethrin) and 10% d-phenothrin.

10% d-phenothrin

The application rate (T409-b-1) is 8 g/1,000 ft³. Without an extender tube, the aerosol can is calibrated to dispense 5 grams per second; therefore 8 grams per 1,000 cubic feet will take 1.6 seconds to dispense.

CAUTION

10% d-phenothrin is **not** approved for use in California, **except** in Federal installations such as military airports.

Apply 10% d-phenothrin in the cargo or passenger areas of the aircraft no more than one hour before loading.

The time needed to spray the aerosol is a function the following three things:

- ◆ Volume (in 1000 cubic feet) of a specific area in the aircraft
- ◆ Spray rate of the nozzle (in grams per second)
- ◆ Required application rate for the pesticide (in grams per 1000 cubic feet)

This relationship is shown in the formula in [Figure 2-12-1](#).

$$\text{Volume of a specific area in the aircraft} \times \frac{\text{Required Application Rate}}{\text{Spray Rate of Nozzle}} = \text{Time Needed to Spray Aerosol}$$

Figure 2-12-1 Formula for Calculating Aerosol Spray Time in Specific Areas of Aircraft

EXAMPLE You are supervising the application of 10% d-phenothrin. The volume of the aircraft cabin is 10,800 ft³. The required application rate is 8g/1,000 ft³. The spray rate of the nozzle is 5.0 g/sec.

$$10,800/1,000 = 10.8 \text{ units of } 1,000 \text{ ft}^3$$

$$8/5 = 1.6 \text{ seconds}$$

$$1.6 \text{ seconds} \times 10.8 = 17.3 \text{ or } 17 \text{ seconds of dispensing time}$$

Passenger Compartment Application

Treatment of passenger compartments is under the authority of a compliance agreement between PPQ and the airline or other contractor.

CAUTION

Never treat passenger compartments when passengers are inside.

Ensure that the compliance holder follows these application procedures:

1. Vacuum the compartment before treatment.
2. Close flight deck windows.
3. Thoroughly inspect flight deck area and remove any insects. Keep windows closed until departure.

4. Close flight deck door to prevent aerosol from entering the flight deck.
5. Install barrier curtains (i.e. doors, plastic sheets, or prefabricated structures) in galley areas to prevent aerosol particles from entering the galley area.

NOTICE

Curtains must be full-length to prevent the entrance of aerosol particles into the galley. If the curtains are not full-length, use other means to seal the entrance. Airlines should provide materials, such as polyethylene, to seal galley areas.

6. Outside the galley areas, cover the following items with an impervious material, such as polyethylene.
 - ❖ Beverage and food preparation surfaces
 - ❖ Exposed oxygen masks
7. Open doors to bathrooms and carefully inspect. Remove any insects, then close bathroom doors.
8. Check aisles and remove all obstacles.
9. Put on safety glasses (and respirator, if desired).
10. Stop all aircraft ventilation systems.
11. Close aircraft entrance doors.
12. Treat at the rates in T409-b-1.
13. Start (perhaps with another applicator) 10 feet from the end of the aircraft. While backing slowly through the aircraft, dispense aerosol in a sweeping motion with cans pointing upward at a 45° angle. Keep the dispensing valve fully depressed. To avoid wetting surfaces, hold the nozzle at least 18 inches away from all surfaces.
14. When treating passenger aircraft with two aisles, it is recommended to have two individuals dispensing the material at the same time. When dispensing the aerosol, use a stopwatch, a wristwatch with a second hand, or count aloud using the technique 1001, 1002, etc. Accurate timing not only ensures the proper amount is dispensed, but also increases the likelihood of obtaining an equal distribution.
15. Exit the aircraft and close all doors.
16. Keep the aircraft closed for 15 minutes post-treatment.
17. After the 15-minute post-treatment period, start the aircraft ventilation system.
18. Ventilate the aircraft for 15 minutes before boarding passengers, crew, or ground personnel.

⚠ WARNING

The individual who starts the ventilation equipment must wear safety glasses.

19. If aerosol particles are still noted in the air after the ventilation period, continue aeration until the particles disappear.
20. After treatment and ventilation, safeguard the aircraft until departure.

Post-Treatment Cleanup Procedure

Ensure that the compliance holder follows these post-treatment clean up procedures:

- ◆ Do not open flight deck doors.
- ◆ Do not remove barriers from galleys until catering is completed; insects can enter during the catering process.
- ◆ Reinspect and collect all insects.
- ◆ Remove covers used to protect specific items outside the galley (e.g., drinking fountains).
- ◆ Thoroughly wash hands, faces, and arms before smoking, eating, or drinking.

Maintaining a Pest-Free Condition in the Passenger Compartment

After treating a passenger compartment, ensure that the aircraft is kept pest-free with the following procedures:

- ◆ Keep the barrier (closure, curtain, or door) from the galley to the inside of the aircraft closed until after catering. After catering, thoroughly inspect for insects in the galley area.
- ◆ Monitor the entrance to the aircraft to determine if insects are entering.
- ◆ Remove and destroy any insects that enter the aircraft.
- ◆ Use enclosed walkways to board passengers either from the terminal or from the vehicles carrying passengers to the aircraft.

Treating Baggage/Cargo Holds

Whenever possible, treat baggage/cargo holds before loading. Treatment before loading allows penetration of the insecticide to cargo areas that become inaccessible after loading.

Loaded aircraft that stand open during the day **must** be treated, regardless of loading time. Insects often fly into and remain in open aircraft.

NOTICE

Military (and other) cargo is often stored outside on pallets for lengthy periods. Insects (Japanese beetles in particular) often rest overnight on the cargo pallets. Loading the aircraft with infested pallets will infest the aircraft. Therefore, treat the aircraft holds containing cargo pallets that have been stored outside and are likely to be infested. After treatment, remove all insects.

Treating Loaded Baggage/Cargo Holds

To treat a loaded baggage/cargo hold, ensure that the compliance holder follows these application procedures:

1. Ensure that there are no live animals on board before treatment. (If there are, remove them (in cages or holding containers) to a protected area, away from the treatment environment.)
2. If possible, visually inspect baggage/cargo hold before loading; collect and destroy all insects found.
3. If possible, visually inspect all baggage or cargo as it is being loaded.
4. Put on safety glasses (and respirator, if desired).
5. Treat the baggage/cargo hold at the rates in T409-b-1.
6. In small holds, open the hatch just enough to allow a hand and the aerosol container inside; as an alternative, apply through an open porthole, if available, in the hatch. Many holds are small; therefore, applicators may treat these small areas by standing at the hatch and directing the spray either aft or forward.
7. If live animals are being shipped following treatment, keep baggage/cargo hold closed for 15 minutes.
8. Open the hold door(s); use a mechanical barrier to protect the treated hold.
9. Ventilate the baggage/cargo hold for 15 - 30 minutes.
10. If live animals are being shipped, check the animals and cages for live beetles before loading and then reload the animals.
11. Close hold door(s).

Treating Unloaded Baggage/Cargo Pods

To treat unloaded baggage/cargo pods, ensure that the compliance holder follows these application procedures:

1. Select relatively airtight pods in good condition and without hand holes.
2. Put on safety glasses (and respirator, if desired).
3. Slightly open the pod door.
4. Spray for 1 second.
5. Keep pod closed for 15 minutes.
6. Open and ventilate the pod for 15 - 30 minutes.
7. Load baggage or cargo.
8. Close pod.

Precautions for Aircraft Transiting Airports at High-Risk for Japanese Beetles

The following precautions must be used for aircraft transiting high-risk airports.

- ◆ Keep cargo holds closed except during loading and unloading.
- ◆ Keep flight deck windows closed.
- ◆ Seal off the galley(s) if the aircraft is to be catered at the hazardous airport. Inspect galleys after catering, but before removing barriers separating the galleys from the cabins.
- ◆ Use enclosed walkways to board passengers. Always keep the enclosed walkway tight against the aircraft.

2% d-phenothrin + 2% permethrin

Currently, there is one manufacturer of this aerosol, 1-Shot™, Callington Inc. 1-Shot™ is labeled for use only in aircraft.

The application rate (refer to T409-b-3) is 40 g/1,000 ft³. One, 150-gram can treats 3,750 cubic feet and takes 75 seconds to dispense completely.

CAUTION

Do **not** apply in the passenger cabin area of the aircraft or when passengers or crew are present.

Apply using the following procedures:

1. Calculate the number of cans needed (refer to Table 5-5-7 through Table 5-5-29 or use the formula in [Figure 2-12-1](#) on page [2-12-2](#)).
2. Prearrange cans in the treatment areas.
3. Dispense partial cans into the farthest parts of the cargo hold before dispensing full cans. Carefully remove the locking tab that keeps the nozzle depressed using caution not to damage the dispensing mechanism. ([Figure 2-12-2](#))
4. Fully depress the nozzle when dispensing.
5. To dispense a full can, depress the spray nozzle on the top of the can until the locking tab engages. Once the locking tab is engaged, the can sprays continuously until empty. ([Figure 2-12-3](#))

- Ventilate the aircraft for 30 minutes before boarding passengers, crew, or ground personnel.

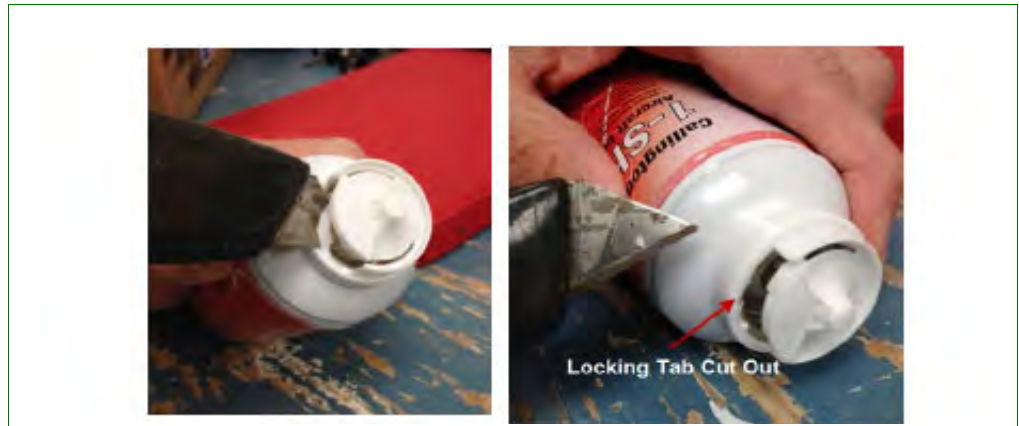

Figure 2-12-2 Preparing to Dispense a Partial Can of 2% d-phenothrin + 2% permethrin

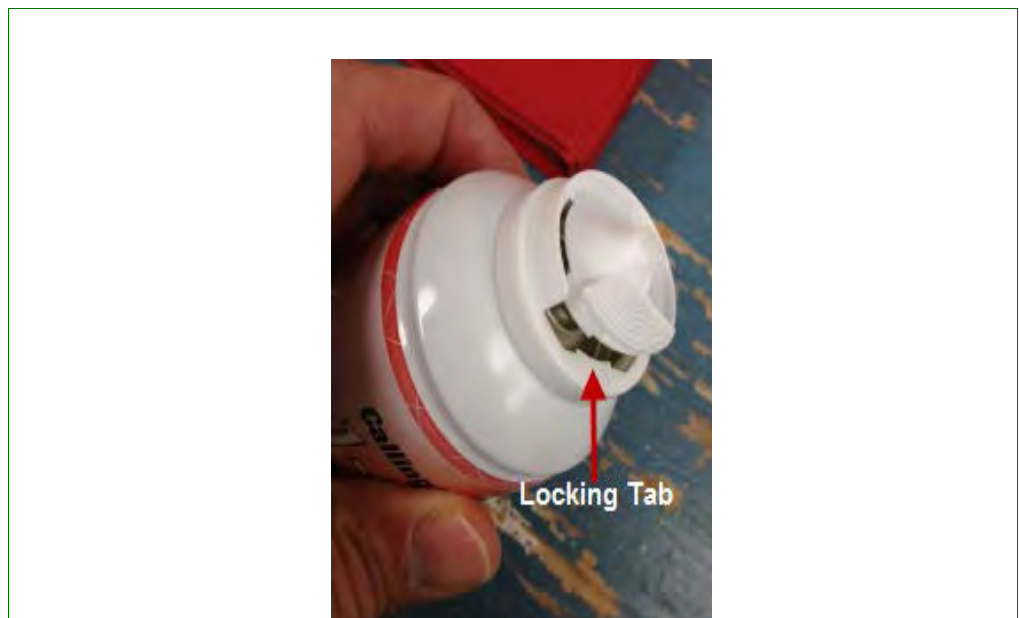

Figure 2-12-3 Preparing to Dispense a Full Can of 2% d-phenothrin + 2% permethrin

Ordering Information

10% d-phenothrin

Currently, 10 percent d-phenothrin is available from USDA-APHIS-PPQ. For ordering and shipping information, contact your Field Operations Program Manager or the USDA-APHIS-PPQ Quarantine and Policy Analysis staff in Riverdale, Maryland.

CAUTION

10% d-phenothrin is **not** approved for use in California, **except** in Federal installations such as military airports.

NOTICE

Supplies are limited.
10% d-phenothrin will be available only until existing supplies are depleted.

2% d-phenothrin + 2% permethrin

Purchase 1-Shot™ directly from the manufacturer (Callington Inc.) using a micropurchase card. Email the following information to orders@callington.com:

- ◆ Delivery address
- ◆ Method of payment
- ◆ Quantity (consider local storage capabilities)

Precautions

Refer to the manufacturer's labels and material safety data sheets for more detailed safety instructions, but in general:

- ◆ Do **not** apply when animals or people are present.
- ◆ Do **not** smoke or eat during application and not until after washing. Wash as soon as possible after application of pesticides.
- ◆ Remove or cover food, food preparation surfaces, and equipment prior to treatment.
- ◆ The applicator may wear a suitable respirator, approved by the National Institute of Safety and Health (NIOSH).
- ◆ The applicator may wear goggles or safety glasses if the applicator experiences any eye irritation.
- ◆ Wipe any pesticide residue noted on smooth surfaces after treatment using a clean damp cloth.

Chemical Treatments

Dips

Contents

Overview	2-13-1
Safety and Dip Treatment Equipment and Materials	2-13-1
Personal Protective Equipment (PPE)	2-13-1
Dip Treatment Equipment and Materials	2-13-2
Dip Treatment Procedures	2-13-3
Sodium Hypochlorite (Bleach) Treatments	2-13-5
Bleach Product Formulation Dilution Information	2-13-5
Adjusting pH	2-13-7
Using pH Test Color Strips	2-13-7
Health and Safety When Adjusting pH	2-13-7
Safety Responsibilities	2-13-8

Overview

As with other treatments, chemical dips require careful planning and preparation. Make sure you have all the necessary safety and treatment equipment and materials ready before you start the dip treatment procedure. When you handle pesticides, always comply with the pesticide label instructions, and State and local regulations.

Safety and Dip Treatment Equipment and Materials

The following lists include safety equipment (personal protective equipment, PPE) and basic material that you will need for dip treatments. However, other materials may be required by additional label requirements that are specific to the chemical being used.

Personal Protective Equipment (PPE)

Always check the label and Safety Data Sheet (SDS) for additional requirements of personal protective equipment. The following is a basic list of PPE that you will need for dip treatments:

- ◆ Chemical-resistant footwear (rubber or neoprene boots)
- ◆ Chemical-resistant gloves (neoprene)
- ◆ Chemical-resistant headgear for overhead exposure
- ◆ Chemical-resistant rain suit with hood

- ◆ Protective eye wear (goggles)
- ◆ Respirator (per label and SDS requirements)

Dip Treatment Equipment and Materials

Always check the label for additional requirements for equipment and materials. The following is a basic list of equipment and materials you will need for dip treatments:

- ◆ Fans¹

NOTICE

A mechanical exhaust is the preferred method of aeration when it is specifically installed to remove chemical fumes from the treatment area. Fans may be used if they do **not** cause airborne pesticides to contaminate the treatment facility or the breathable air. The flow of air should be across the dip vat/container and away from people in the treatment area.

- ◆ Liquid soap¹
- ◆ Mixing containers and dipping containers **must** be provided with lids to prevent spills during transportation and storage
- ◆ New boxes (when reconditioning or excess contamination of original boxes is **not** possible)
- ◆ Newspaper or any other absorbent paper

NOTICE

Place plastic backed paper on pallets prior to covering with paper and/or absorbent paper to preclude the pesticide being absorbed onto the wood.

- ◆ Packing material¹
- ◆ Pallets¹

NOTICE

Place plastic backed paper on pallets prior to covering with paper and/or absorbent paper to preclude the pesticide being absorbed onto the wood.

- ◆ Pesticides

NOTICE

Pesticides should be fresh (**not** over 1 year old). Labels and SDS **must** be attached to the pesticide container and all instructions **must** be followed.

- ◆ Plastic bags (4 to 6 mil plastic)¹
- ◆ Shear scissors

¹ This equipment will be provided by USDA when available.

- ◆ Sponges

Dip Treatment Procedures

Step 1: Plan for the Dip Treatment

Before you start the dip treatment, inform the customer (broker/importer) of the specific material and PPE that will be needed to perform the dip treatment procedure. All required materials and equipment **must** be available at the time of treatment.

Step 2: Designate Restricted Use Areas

Designate the following restricted use areas:

- ◆ **Measuring and mixing area**—The measuring and mixing area for the specific pesticide(s) **must** be in a well-ventilated area away from food preparation, eating areas, and offices. Areas that contain mechanical exhaust systems are preferred.
- ◆ **Plant material dipping area**—The plant material dipping area **must** be an area where access is limited by a barricade or warning signs. Areas that contain mechanical exhaust systems are preferred.
- ◆ **Plant material drying area**—The plant material drying area **must** have proper air circulation and exhaust ventilation. These areas should be closed to the dipping area. The route from the dipping area to the drying area should be lined with plastic backed absorbent paper or plastic and paper to catch excess pesticide solution.

Step 3: Prepare Plant Material

Prepare the plant material for the dip treatment according to the *PPQ Treatment Manual* and pesticide label requirements.

Step 4: Prepare the Pesticide Solution

CAUTION

Wear PPE and keep the exhaust system running when you are preparing pesticide solutions. To minimize your exposure to the pesticide dust or airborne particles, keep the pesticide between you and the exhaust.

1. Measure the amount of water required for the treatment.
2. Measure the amount of pesticide required for the treatment.

NOTICE

It is important to use fresh chemicals for every solution. If questions arise during this procedure, stop and seek assistance from the USDA-APHIS-PPQ-S&T-TMT (305) 278-4877.

3. Prepare a pesticide paste as follows:

- A. Add the previously measured amount of water into a clean and empty container, for example, an empty can or plastic container.
 - B. Form a paste (with dry pesticides) by adding the measured pesticide to the small amount of water and mix gently.
 - C. Dilute the paste by slowly adding more water from the previously measured water.
 - D. Slowly add the concentrated solution(s) to the rest of the measured water.
4. Add some drops of liquid soap to the solution (soap is used as a sticking agent).
 5. Mix the final solution by stirring it gently.

Step 5: Dip the Plants in the Pesticide Solution

Dip the plants in the solution for the time required by this manual.

Step 6: Remove the Plants from the Pesticide Solution

Remove the plants from the solution and allow excess solution to drip into the dipping container.

Step 7: Dry the Plants

Place the plants on newspaper covered pallets and allow them to dry (make sure to space the plants out for maximum drying).

 CAUTION

Thoroughly dry the plants before releasing them to the customer.

Step 8: Disinfect Original Shipping Containers

Disinfect the original shipping containers with a sponge containing the pesticide solution. The plant material may be packed with new packing material in a previously used container that has been disinfected.

Step 9: Clean Up the Treatment Area and Equipment

Discard all empty containers, excess pesticides, packing materials, plastic bags/backing materials, and newspaper/absorbent paper in compliance with instructions on the label and State/local regulations. Decontaminate all treatment areas and equipment while you are wearing your PPE.

Step 10: Release the Cargo

After the plant material is dry, release it to the customer or broker if agreed to by the airline and if it has been released by Customs.

Sodium Hypochlorite (Bleach) Treatments

Sodium hypochlorite is considered a pesticide and is regulated by the EPA. Applicators must follow the EPA label and have it available when applying sodium hypochlorite. Each EPA registration has a rate, application method, and site. The site being treated **must** be listed on the label. If the site is not on the EPA label, you cannot use the product.

The applicator must read and follow all precautionary statements on the EPA label and associated container. Always refer to the EPA label for use sites and dilutions.

Bleach Product Formulation Dilution Information

Refer to the label to determine the concentration (% concentrate) of the sodium hypochlorite product you are using. In the example in [Figure 2-13-1](#), the percent concentrate is 8.25%.

Active Ingredient:	
Sodium Hypochlorite	8.25%
Other Ingredients:	91.75%
Total:	100.00%

Figure 2-13-1 Example of % Concentrate From Puma® Label (EPA #5813-100)

Determine the total parts of water needed using the formula in [Figure 2-13-2](#).

$$\frac{\text{BleachConcentrate}}{\text{DesiredFinalDilution}} - 1 = \text{Total Parts Water}$$

Figure 2-13-2 Formula to Determine Total Parts of Water to Prepare a Bleach Disinfectant

EXAMPLE The treatment schedule, T511-1, requires a 0.525% chlorine solution (5,250 ppm). The sodium hypochlorite product you are using has 8.25% active ingredient.

Calculate the dilution as follows:

$$[8.25\% / 0.525\%] - 1 = 15.71 - 1 = 14.71$$

Do **not** convert the percentage values to decimals before dividing. The final result can be rounded up or down.

In this example, you would take 1 part of the 8.25% product and add 15 equal parts of water to make a 0.525% disinfecting solution.

Apply this dilution using any volume. For example:

- ◆ Mix 1 cup bleach with 15 cups water.
- ◆ Mix 1 tablespoon bleach with 15 tablespoons water.

Table 2-13-1 provides calculated values of common dilution formulations used by PPQ. If the bleach formulation and desired solution values are not included in Table 2-13-1, refer to the formula in Figure 2-13-2.

Table 2-13-1 Common Products Dilution Ratio to Add to 1 Part Bleach

Bleach Formulation	Desired Solution (PPM)	Parts Volume of Water
5.25%	200	262
	5,250	9
6%	200	299
	5,250	10
8.25%	200	411
	5,250	15
8.3%	200	414
	5,250	15
8.4%	200	419
	5,250	15
8.5%	200	424
	5,250	15
8.6%	200	429
	5,250	15
10%	200	499
	5,250	18
12.5%	200	624
	5,250	23
15%	200	749
	5,250	28

Adjusting pH

The bleach solution **must** be pH 5.5 to 7.0. Use pH test color strip kits to determine the pH of the solution. If needed, adjust the pH to 5.5 to 7.0 using 5% acetic acid (white vinegar) under a fume hood or in a well-ventilated area. Avoid a pH lower than 5.5.

Using pH Test Color Strips

Use pH test strips with a range of 0-14 pH with color chart intervals from 1 to 14.

1. Remove the test strip from the bottle and recap the bottle tightly.
2. Dip the strip in the bleach solution deep enough to wet the test pad(s) and remove according to bottle directions.
3. Remove excess water by shaking the strip once briskly according to bottle directions.
4. Hold strip horizontally, pad side up, for 15 seconds according to bottle directions.
5. Compare the color of the strip with the color chart on the bottle.

Health and Safety When Adjusting pH

Acidifying sodium hypochlorite solutions to modify the pH may result in release of chlorine gas.

WARNING

Chlorine gas can cause severe skin burns and eye damage. It is corrosive to the respiratory tract and may be fatal if inhaled. Adverse symptoms may include pain and redness in the eyes, coughing, blistering of the skin, and stomach pain. The absence of odor is not a reliable indicator of safety.

Follow all safety precautions listed on the label. Precautions include, but are not limited to:

- ◆ **Respiratory Protection**—When exposures exceed the OSHA 8-hour time weighted average of 0.5 ppm or the OSHA 15-minute short term exposure limit of 1 ppm, an air-purifying respirator with proper chemical cartridges or air-supplying respirator must be worn. When exposure levels exceed the NIOSH IDLH of 10 ppm, an air-supplying respirator must be worn.
- ◆ **Personal Protective Equipment (PPE)**—Wear ANSI-approved safety glasses or goggles, chemical resistant gloves, lab coat or protective clothing, long pants, and closed-toe shoes.

- ◆ Engineering Controls—Work under a certified chemical fume hood. In the field, ensure adequate exhaust ventilation is provided to ensure exposures remain permissible exposure levels.

Safety Responsibilities

The PPQ Officer is responsible for the following safety issues:

- ◆ Make the broker/importer aware of his or her responsibilities as it pertains to:
 - ❖ Materials
 - ❖ Personal protective equipment (PPE)
 - ❖ Health hazard and safety concerns when performing the dip treatment process
- ◆ All personnel involved in the dip treatment process are required to wear the appropriate and label required PPE while performing the treatment. PPQ Officers may need to wear PPE if the dip treatment process area prevents them from observing the process from outside the restricted area.
- ◆ Designated dip treatment process areas **must** be located away from food preparation, eating areas, and offices. Make every effort to place dip treatment processes in an area containing a mechanical exhaust.
- ◆ The broker/importer personnel involved with treatments **must** be aware and briefed on the location of the emergency eyewash and all other required safety equipment. They also need to be aware of the areas that they will be limited to working within and any other specific restrictions determined by the PPQ Officer in charge of the process. The PPQ Officer monitoring the process should be aware of the procedures to be followed in the event of an accidental release of the pesticide or an injury to one of the broker/importer's personnel.
- ◆ The broker/importer personnel should shower as soon as possible after performing a dip treatment. The PPQ Officer should ensure that personnel are aware of the location and route to the shower. Guidance should also include instruction on how to disrobe and dispose of clothing used during dip treatment processes. All contaminated clothing and PPE **must** be removed before entering the shower room. Contaminated clothing should be placed in plastic bags and PPE in separate plastic bags.
- ◆ Inform the broker/importer personnel that clothes worn during treatment **must** be washed in hot water with detergent and that they should be washed separately from other clothes.

- ◆ Release the plant material to the broker/importer only if they are using or provide a vehicle that has a compartment physically separated from the cab, for example, a pick-up truck or tractor trailer.

Chapter

2

Chemical Treatments

Dusts

Contents

This section for future development.

Chapter

2

Chemical Treatments

Sprays

Contents

This section for future development.

Nonchemical Treatments

Overview

Contents

Heat **3-2-1**
Cold Treatment (CT) **3-7-1**
Irradiation **3-8-1**

The nonchemical treatment section of this manual is organized as follows:

- ◆ Cold
- ◆ Heat
- ◆ Irradiation

Use the Table of Contents at the beginning of each section to quickly find the information you need. If the Table of Contents is **not** specific enough, then turn to the Index to find the topic and its page number.

Nonchemical Treatments

Heat

Contents

Introduction	3-2-1
Heat – Hot Water Immersion	3-3-1
Heat – Steam Treatments	3-4-1
Heat – Vapor Heat and Forced Hot Air	3-5-1
Heat – Forced Hot Air – Niger Seed	3-6-1

Introduction

Heat treatments are generally based on maintaining the plant material at a specific temperature for a specified time. Heat treatments, as other quarantine treatments, are designed to kill plant pests without destroying or appreciably devaluing the infested commodity. The following heat treatments are described in this section:

- ◆ Hot Water Immersion Treatment
- ◆ Steam Treatments
- ◆ Vapor Heat and Forced Hot Air Treatment
- ◆ Forced Hot Air – Niger Seed

Nonchemical Treatments

Heat – Hot Water Immersion

Contents

Hot Water Immersion Treatment—Fruit Fly Host Commodities Such as Mangoes	3-3-3
Principle	3-3-3
Schedules	3-3-3
Procedures	3-3-3
Checklist of USDA-APHIS Minimum Requirements for Hot Water Immersion Treatment Facilities: General Requirements	3-3-4
Proposal Submission	3-3-4
On-Site Inspection Option	3-3-4
Facility Design	3-3-4
Electrical and Electronic Components	3-3-6
Wiring	3-3-6
Computers and Microprocessors	3-3-6
Commercial Line Conditioner (Surge Protector)	3-3-6
Electrical Generator	3-3-6
Fruit Sizing Equipment	3-3-6
Boilers and Thermostatic Controls	3-3-7
Adequate Water Heating Capacity	3-3-7
Thermostatic Controls (Set Point)	3-3-7
Multiple Set Point Option	3-3-7
Water Circulation	3-3-8
Temperature Sensors	3-3-8
Type of Sensor	3-3-8
Number of Sensors Required and Their Placement	3-3-8
Tank Access for Temporary Placement of Portable Sensors	3-3-9
Certified Glass-Mercury, Non-mercury, and Digital Thermometer	3-3-9
Temperature Recorder	3-3-9
Automatic Operation	3-3-9
Long-Term Recording	3-3-9
Recording Frequency	3-3-9
Accuracy	3-3-10
Repeatability	3-3-10
Calibration	3-3-10
Range	3-3-10
APHIS-Approved Recorder Models	3-3-10
Approved Strip Chart (Pen) Recorder Models	3-3-11
Approved Data Logger Recorder Models	3-3-11

Chart Paper Specifications	3-3-12
Alarm System	3-3-13
Safeguarding the Treated Fruit	3-3-13
Layout and Flow Pattern	3-3-13
Garbage Disposal	3-3-13
Quarantine Area	3-3-13
Pretreatment Warming Options	3-3-14
Post-treatment Cooling Options	3-3-14
Refrigerated Room	3-3-15
Fans	3-3-15
Hydrocooling	3-3-15
Facility Changes	3-3-15
Safety and Health Checklist	3-3-15
Work Plan	3-3-16
Plant Material Not Tolerant to Fumigation	3-3-16
Address for Technical Contact	3-3-17

Hot Water Immersion Treatment—Fruit Fly Host Commodities Such as Mangoes

Principle

Hot water immersion treatment (also called hydrothermal treatment) uses heated water to raise the temperature of the commodity to the required temperature for a specified period of time. This is used primarily for certain fruits that are hosts of fruit flies, but may also be used for nursery stock for a variety of pests.

Schedules

Refer to the appropriate section in this manual for treatment schedules. The time/temperature relationship varies with the commodity and pest. Typically, the pulp temperature is raised using water heated to between 115 °F and 118 °F for a prescribed period of time.

Procedures

- ◆ Before the start of each treatment, examine the facility for proper operation of the heating, circulation, and recording equipment. Examine continuous flow equipment (submerged conveyor belt) at the start of each day or run.
- ◆ Commodities subject to size restrictions require a preliminary culling procedure to eliminate oversized items prior to treatment.
- ◆ Conduct all treatments in an approved tank.
- ◆ Entire treatment will be under general monitoring of APHIS, and may be further governed by a signed work plan (for foreign facilities), or compliance agreement (for domestic facilities).
- ◆ Load immersion tanks in a manner approved by the USDA, usually using baskets with perforations that allow adequate water circulation and heat exchange.
- ◆ Number each treatment container or lot before placing in the immersion tank.
- ◆ Record the temperature and duration of each hot water dip with an automatic temperature recording system.
 - ❖ A responsible employee of the packing company **must** indicate on the printed temperature record the starting time, lot number, duration of each treatment, and initial each entry.
 - ❖ An alternative recording system can be used only with prior APHIS approval.

- ❖ During certification, the average pulp temperature becomes the minimum commercial treatment pulp temperature.
- ❖ During commercial treatments, the “Adjusted Tank Sensor Temperature” is used as the lowest treatment temperature. *See [Hypothetical Certification Results: Treatment Tank with Multiple Set Points](#) on page 6-5-3 for more information.*
- ◆ Stamp all boxes of hot water-treated fruit, “Treated with Hot Water, APHIS-USDA,” together with the numerical designation APHIS has assigned to the particular treatment facility.
- ◆ When treatment is complete, promptly move commodities treated at origin to an insect-free enclosure.
 - ❖ Use insect-proof containers, screened or enclosed rooms, doors with air curtains, or some combination to maintain commodities insect free throughout the shipping process.

Checklist of USDA-APHIS Minimum Requirements for Hot Water Immersion Treatment Facilities: General Requirements

Proposal Submission

Follow guidance from APHIS-PPQ Preclearance and Offshore Programs (POP) when submitting proposals for new hot water facilities.

On-Site Inspection Option

When the construction is 75 percent complete, the firm can request APHIS to make an on-site inspection. This interim inspection is optional. However, a final inspection is required, as well as performance tests of the equipment. All costs involved **must** be prepaid by the requesting firm.

Facility Design

APHIS does **not** provide construction details, but only this list of minimum requirements. Design and construction of the hot water facility is the responsibility of the owner, in consultation with an engineering firm. (Engineering firms and sources of supply are provided in [Appendix E](#) on page [E-1-1](#)). To take into account variations in facility size, availability of materials, economic feasibility, and individual preference, APHIS allows a wide range of design flexibility.

Although each facility is somewhat unique, there are two basic designs for hot water facilities. The two types are referred to as the [Batch System \(Sometimes called “Jacuzzi System”\)](#) and the [Continuous Flow System](#).

Batch System (Sometimes called “Jacuzzi System”)

Most hot water immersion treatment facilities are the batch system type. In this system, baskets of fruit are loaded onto a platform, which is then lowered into the hot water immersion tank where the fruit remain at the prescribed temperature for a certain length of time, then are taken out, usually by means of an overhead hoist. In this system, the treatment chart **must** indicate (by an identifiable marking) when a fruit basket is prematurely removed from the tank. Other alternatives include a solenoid switch, sensor, or similar device that disengages whenever a basket is removed from the treatment tank, or a locking device to make it physically impossible to remove the fruit until the treatment is fully complete.

Continuous Flow System

In the continuous flow type of system, the fruit are submerged (either loosely or in wire or plastic mesh baskets) on a conveyor belt, which moves slowly from one end of the hot water tank to the other. Belt speed is set to ensure the fruits are submerged for the required length of time. This system requires an instrument to monitor the speed of the conveyor belt. This can be accomplished by attaching a speed indicator (encoder) to the gear mechanism. The belt speed is recorded on the same chart as the time and temperature, and also indicates whether the belt is moving or stopped during the treatment cycle. Smaller fruits require less treatment time than larger fruits. Therefore, conveyor belt speed should be adjustable to accommodate treatments of different lengths of time. As an alternative, the belt speed may remain constant, but the length of the submerged portion of the belt is adjusted according to the length of treatment time required for the particular size of fruit. The conveyor **must** prohibit either forward or backward movement of the fruit during treatment (due to flotation).

Some operators believe that treating fruit while it passes through the system on a conveyor belt is an advantage. Few new systems of this type were built after 1990, presumably because mechanical fruit damage (scratching of the peel) often occurs if the fruit are **not** in baskets. The system also occupies much more floor space in the plant than a batch system.

Water Quality

The water used for washing, dipping, hydrocooling, or showering the fruit should be chlorinated at a level **not** to exceed 200 parts per million (ppm). This level is easier to maintain if the water is first filtered and run through a flocculation process to remove organic material that would otherwise bind with the chlorine.

The facility should check the water for microbial contamination on a regular basis. To maintain sanitary conditions, change water as necessary. Implement standard operating procedures to include water change schedules for all

processes that use water. To ensure the safety of the fruit, the facility **must** clean and sanitize surfaces that come into contact with water, such as wash tanks, hot water tanks, and hydrocooling tanks, as often as necessary. To ensure efficient operation, routinely inspect and maintain equipment designed to assist in maintaining water quality, such as chlorine injectors, filtration systems, and backflow devices.

 **CAUTION**

Periodic monitoring by the facility is critical, because chlorine levels above 300 ppm can result in metal corrosion.

Electrical and Electronic Components

Wiring

Electrical wiring throughout the facility **must** meet both international, as well as local safety code requirements. To eliminate shock hazard, earth grounding is required for all electrical wiring located in the vicinity of water. To prevent damage, shield wires inside metal or PVC conduit.

Computers and Microprocessors

To maintain accuracy and reliability, place computers and microprocessors in a climate-controlled (air conditioned) room. This room should be above tank level, provide a clear view of the treatment tank(s), and be lockable. This room can also serve as an office for the inspector.

Commercial Line Conditioner (Surge Protector)

A commercial line conditioner is recommended for use with computers and microprocessors to provide protection from voltage irregularity (power surges), noise reduction, and harmonic distortion.

Electrical Generator

In the event of a power outage and to provide a secondary source of electricity to enable continued plant operation, an electrical generator is recommended as a backup power supply.

Fruit Sizing Equipment

In the treatment schedule, the duration of hot water immersion depends on the particular weight class and variety of the fruit being processed. The inspector **must** visually inspect and weigh the largest fruit until the inspector is satisfied that **all** of the fruit is within the weight class. The weight inspection **must** occur for each lot change (orchard or variety) to ensure the accuracy of the sizing equipment. **No** mangoes will be accepted that are over the weight class.

It is very important to have accurate sizing equipment that sorts the fruit into groups, either by diameter or by weight. (Weight sorting is the preferred method.) If the weight range is too broad, recalibrate the equipment.

Boilers and Thermostatic Controls

Adequate Water Heating Capacity

The hot water facility **must** have adequate water heating capacity (i.e., a powerful enough boiler), and accurate enough thermostatic controls to hold the water temperature at or above the temperatures prescribed in the treatment schedule for the given length of time.

Thermostatic Controls (Set Point)

APHIS requires that the thermostatic controls be automatic. The temperature set point(s) are determined and approved during the official performance test, and **must** be high enough to ensure the water in the treatment tank will meet or exceed the minimum treatment temperature prescribed for the fruit. Once approved, do **not** tamper with the temperature set points. Temperature set points **must** remain constant for the entire shipping season. However, if the operator of the facility requests a change in set points, the inspector should conduct a new performance test. If this test is unsuccessful, revert the tanks to their prior set points.

Multiple Set Point Option

Managers of some facilities use multiple set points for each tank. The initial set point is higher than the other set points. All set points will be selected by the facility manager or systems engineer based on results of the preliminary performance test.

Verify the set points during the official performance test, and the same procedure **must** be repeated on each subsequent commercial treatment. This system works only for tanks that treat only one cage (basket) of fruit at a time.

NOTICE

Tanks are **not** allowed to have any set point that is lower than the standard treatment temperature for the commodity being treated (115 °F in the case of mangoes).

Water Circulation

Install a water circulation system in the tank to provide uniform water temperatures throughout the treatment process and to avoid the formation of cool pockets during treatment. To guarantee that the equipment is **not** turned off during the treatment process, the controls for the circulation pumps or propellers **must** be tamper resistant. For the safety of personnel working in the area, shield pulleys on all pumps located within 6 feet of the floor.

After the first 5 minutes of treatment (with the tank sensor at “lowest temperature permitted at that set point”), differences in the lowest and highest actual temperature sensor readings of more than 1.8 °F may be accepted on a case-by-case basis.

Using a flotation barrier, keep the fruit at least 4 inches (10.2 cm) below the water surface during the treatment.

Temperature Sensors

Type of Sensor

Permanently install platinum 100-ohm resistive thermal detectors (RTD sensors) in the lower third of the tank. The resistance of an RTD sensor linearly changes with temperature, whereas thermistors and thermocouples are nonlinear and less stable. Major advantages of RTD sensors include long-term stability, high signal levels, and overall accuracy of the system. Place the sensor unit within the distal 1 inch (2.54 cm) of the sensor rod. The sensor **must** have an outer sheath of 0.25 inch (6.4 mm) or less in diameter.

Number of Sensors Required and Their Placement

For continuous flow systems, the minimum number of sensors required is at least 10 per tank, which **must** be spaced throughout the length of the conveyor. For batch systems, the requirement is at least two sensors per tank. However, in tanks that treat multiple baskets (cages) of fruit, there **must** be at least one sensor per basket position. (A tank with four basket positions, for example, would require at least four sensors.) In both the batch and continuous flow systems, install sensors in the lower third of the tank.

Tank Access for Temporary Placement of Portable Sensors

The hot water tank **must** be designed to accommodate the temporary placement of numerous portable sensors or probes to be used during the performance testing procedure required for certification or recertification. During the testing procedure and at the direction of the inspector who conducts the performance test, position the temporary sensors throughout the load of fruit. The facility is required to purchase and have available 24 portable thermistor or thermocouple sensors (each with its own flexible cord at least 10 feet in length), and a portable temperature monitor that reads to the nearest one-tenth of a degree.

Certified Glass-Mercury, Non-mercury, and Digital Thermometer

The treatment facility is required to have at least one high-accuracy, water-immersible, certified mercury, non-mercury, or digital thermometer on the premises at all times. This thermometer **must** be accurate to 0.1 °F (or C) and will cover the range between 113 °F to 118 °F (45 °C to 47.8 °C). It will be used as the standard against which all sensors are calibrated.

Temperature Recorder

Use an automatic temperature recorder (strip chart or data logger) to record the time and temperature during each treatment.

Automatic Operation

The instrument used for recording the time and temperature **must** be capable of automatic operation whenever the hot water treatment system is activated.

Long-Term Recording

The recording equipment **must** be capable of nonstop recording for an extended period of time. Continuous flow systems require recording equipment capable of operating for up to 12 consecutive hours.

Recording Frequency

The time interval between prints will be **no** less than once every 2 minutes. Alternatively, a strip chart system can be used that gives continuous color pen lines. The numerical print or pen line representing each temperature channel (sensor) **must** be uniquely identified by color, number, or symbol. It is **not** necessary to record temperatures from sensors located in portions of the tank **not** in use.

Accuracy

The accuracy of the temperature recording system (i.e., sensors and recorders) **must** be within 0.5 °F (0.3 °C) of the true temperature (as verified by a certified mercury, non-mercury, or digital thermometer). The temperature variation for the control sensors should be as close to zero as possible.

Repeatability

When used under field conditions over an extended period of time, the recording equipment **must** be capable of repeatability to within 0.1 °F (or C) of the true calibrated readings. Failure to maintain reliability, accuracy, and readability in a previously approved instrument will result in canceling approval. The design, construction, and materials **must** be such that the typical environmental conditions (including vibration) will **not** affect performance.

Calibration

Individually calibrate channels (sensors) against a certified mercury, non-mercury, or digital thermometer reading in tenths of a degree Fahrenheit or Centigrade, within the range of 113 °F to 118 °F (45 °C to 47.8 °C). The engineering firm that installs the recording equipment **must** also calibrate it. (Calibration equipment often used for this purpose includes, for example, a Decade instrument and relay range cards.) Calibrate the sensors at or near the fruit treatment temperature (around 115 °F), **not** at 32 °F.

Range

The recorder **must** be programmed to cover the entire range between 113 °F to 118 °F (45 °C to 47.8 °C), with a resolution of one-tenth of a degree. The range should **not** extend below 100 °F (37.8 °C) **nor** above 130 °F (54.4 °C). If the range band of the recorder is wider than this, restrict it (narrowed) with proper programming.

APHIS-Approved Recorder Models

Some recorder models currently on the market are **not** approved by APHIS for various reasons. For example, if the recorder only displays the sensor numbers and temperatures **without** making a printout on paper; or if it prints out the temperature data only after the treatment has been completed, it is **not** approved by APHIS. (These are known as “memory loggers.”) These two types of recorder models do **not** provide an adequate level of monitoring during treatment. Also, revolving circular charts are **not** acceptable because of the difficulty in reading fractions of one degree.

Temperature recorder models presently approved by APHIS are listed below. They can be either of the strip chart or data logger type. Some have adjustable chart speeds. Additional temperature recorder models may be added to this list upon petition to the [USDA-APHIS-PPQ-S&T-TMT](#). To seek APHIS approval

for recorder models **not** listed, submit the manufacturer's technical brochure to the [USDA-APHIS-PPQ-S&T-TMT](#) for evaluation.

Approved Strip Chart (Pen) Recorder Models

NOTICE

Strip chart recorders are **no** longer approved for installation in new facilities or used to replace any style of recorder.

- ◆ Chessel 346
- ◆ Honeywell DPR 100A (3-channel capability)
- ◆ Honeywell DPR 100B (6-channel capability)
- ◆ Honeywell DPR 100C (3-channel capability)
- ◆ Honeywell DPR 100D (6-channel capability)
- ◆ Honeywell DPR 180 (36-channel capability)
- ◆ Honeywell DPR 1000 (6-channel capability)
- ◆ Honeywell DPR 3000, version D4 (32-channel capability)
- ◆ Molytek 2702
- ◆ Neuberger P1Y
- ◆ Toshiba AR201
- ◆ Tracor 3000

Approved Data Logger Recorder Models

- ◆ ASICS Systems B & C
- ◆ Chino AA Series
- ◆ Cole Parmer (32-channel capability)
- ◆ Contech (10-, 16-, and 32-channel capability)
 - ❖ Model: Smart Seda
- ◆ Flotek (**must** be attached to a printer)
- ◆ HACCP Warrior PTR-4 (4-channel capability)
- ◆ HAACP Warrior PTR-10 (10-channel capability)
- ◆ Hidrosoft
- ◆ Honeywell DPR I00B (6-channel capability)
- ◆ Honeywell DPR-1500 (30-channel capability)
- ◆ Honeywell DPR-3000, version D4 (32-channel capability)
- ◆ HyThsoft v2
- ◆ IBM-PC (**must** be attached to a printer)

- ◆ Koyo, Model Direct Logic DL 350, with Hidro Soft
- ◆ Nanmac H30-1
- ◆ National Instruments (all HTS models and Labview 6.1 software)
- ◆ NOJOXTEN-BR with software–Automation Studio V 3.09 IEC 61131-3-ST
- ◆ Omega OM-205
- ◆ Omega OM-503
- ◆ Ryan Data Mentor (12-channel capability)
- ◆ Tracor Westronics (DDR10)

Chart Paper Specifications

Celsius or Fahrenheit Scale

Temperature can be recorded either in Fahrenheit or Celsius, although Fahrenheit is preferred by APHIS.

Scale Deflection

Scale deflection on the strip chart paper **must** be at least 0.10 inches for each degree Fahrenheit, or at least 5 mm for each degree Celsius. Greater width between whole degrees, however, is preferred. Between each line representing one degree, there **must** also be finer lines, each representing subdivisions of one-tenth or two-tenths of a degree, in the range of 113 °F to 118 °F (45 °C to 47.8 °C).

Sample Required

Submit a sample of the strip chart or numerical printout made by the recording equipment to [USDA-APHIS-PPQ-S&T-TMT](#). It should be in the exact format to be used at the facility during the treatment cycle. Each symbol on the print wheel (or ink color, in the case of strip charts) **must** correspond to and identify the particular sensor that it represents.

Chart Speed

Chart speed for strip chart recorders **must** be **no** less than 1 inch for every 5 minutes of treatment time.

Chart Length

The chart paper **must** be long enough to display at least 1 entire treatment. Continuous flow systems **must** contain enough chart paper to continuously record temperatures for up to 12 consecutive hours.

Alarm System

An alarm is required for all batch (Jacuzzi) systems, in order to notify packinghouse employees that a treatment has been completed for a particular basket (cage). This system can be an audible noise (such as a horn, buzzer, or bell) or a highly visible light attached to a timing device located on the equipment that indicates time and temperature. Some facilities use both a noise and a light. To avoid “overcooking,” the alarm system alerts the operator of the hoist to remove a basket from the tank at the end of treatment.

Safeguarding the Treated Fruit

Layout and Flow Pattern

Design the flow pattern of the fruit moving through the hot water treatment process to ensure that fruit waiting to be loaded into the hot water immersion tank **cannot** become mixed with fruit that has already completed treatment. Submit a drawing showing the proposed layout of the packinghouse to [USDA-APHIS-PPQ-S&T-TMT](#) for approval.

Garbage Disposal

In order **not** to attract fruit flies, place cut fruit, culled fruit, rotting fruit, and miscellaneous garbage into covered containers and remove from the premises daily.

Quarantine Area

Bring treated fruit to an insect-free enclosure immediately after treatment. The treated fruit **must** remain there until loading into insect-proof shipping containers. The designated enclosure is usually a screened room. Packing line equipment, hydrocooling equipment, and cool storage room (if any), should be located in this area, but this equipment is **not** a requirement. To prevent the movement of untreated fruit (accidentally or intentionally) into the insect-free quarantine area, enforce effective procedures.

Screening and Other Materials

Ordinary window screen or mosquito netting (at least 100 mesh per square inch) is sufficient to exclude fruit flies. Inspect it regularly and repair it as often as needed. Solid glass, concrete, drywall, or wooden walls are also acceptable.

Air Curtain

Place on the wall or ceiling prior to entering any quarantine area an apparatus that generates a high-velocity wind barrier or air curtain (such as fans or blowers and associated air-directing chambers or enclosures such as baffles, boxes, etc.). This device **must** exclude the possible entry of fruit flies into the insect-free enclosure. (For facilities approved prior to July 1, 1997, vertically hang clear plastic flaps, as minimally required, at the doors to the insect-free enclosure.)

Loading of Treated Fruit

When **not** in use, close doors leading from the quarantine area to the loading dock. When loading, truck vans and containers **must** form a fly-proof seal with the exterior wall. Prior to loading, inspect and disinfect truck vans and containers. If wooden pallets are used, they **must** be completely free of wood-infesting insects and bark. Apply a numbered APHIS seal to each container before its departure.

Pretreatment Warming Options

Prewarming the fruit is sometimes desirable in order to meet the APHIS requirement that all fruit pulp temperatures be at least 70 °F before the start of the certification performance test. At the very least, the fruit pulp temperature **must** reach the minimum pulp temperature stabilized during the certification test for commercial treatment. After prewarming, take pulp temperatures from the mangoes located at the coldest part of the crates and/or baskets. Do **not** take the pulp temperatures from the mangoes that are located on the outside of the basket or crate.

Post-treatment Cooling Options

Cooling the fruit after hot water treatment is **not** an APHIS requirement. However, from the standpoint of fruit quality, many facilities choose to install a system to cool the fruit after removal from the hot water.

Hydrocooling of the treated mangoes is allowed after a waiting period of 30 minutes following treatment, unless the original dip times indicated in the treatment schedule are extended for 10 minutes. Allowing the fruit to simply stand for at least 30 minutes after being removed from the hot water tank is thought to be helpful in killing immature stages of fruit flies because the mangoes complete their “cooking” process during that time.

Refrigerated Room

The recommended storage temperature for mangoes is between 55 °F and 57 °F (12.8 °C and 13.9 °C) at 85 to 90 percent relative humidity. These temperatures delay softening and prolong storage life to approximately 2 to 3 weeks.

Fans

APHIS allows the use of fans in the screen room to blow air over the fruit as soon as they are removed from the hot water tank (if desired). However, the ambient air **cannot** be less than 70 °F.

Hydrocooling

APHIS allows the use of a cool water tank or shower system, but with the following provisions:

- ◆ During the waiting period and hydrocooling period, safeguard the mangoes in a room or tunnel, separate from the hot water tanks
- ◆ Water temperatures used during hydrocooling **must** be 70 °F or above
- ◆ Water used for hydrocooling should be chlorinated (**not** to exceed 200 ppm)
 - ❖ Any other chemicals, such as fungicides, are optional, but **must** be approved in advance by the FDA

Facility Changes

Hot water immersion treatment facilities whose construction was approved under earlier guidelines can continue to operate with APHIS approval. Newer facilities, however, are required to meet the current requirements outlined in this checklist, which in most cases are more strict.

Once [USDA-APHIS-PPQ-S&T-TMT](#) has formally approved the plans and drawings for a hot water immersion treatment facility, the facility can make **no** further changes in the equipment **without** APHIS approval. Any proposed changes or improvements **must** be described in writing (with accompanying drawings, if necessary) and **must** be approved by APHIS in writing. Examples of proposed changes include adding additional treatment tanks, adding a cold storage room, and changing the model of the temperature recorder.

Safety and Health Checklist

- ◆ Adequate lavatory
- ◆ Admission of children or unauthorized persons into the treatment and packing areas is prohibited if not accompanied by a responsible employee

- ◆ Approved safety ladders or walkways (catwalks, etc.) for observing treatment tank operations
- ◆ Electric power meets safety code requirements
 - ❖ Electrical wiring, including switches and other connections, contained in metal or PVC conduit and grounded to prevent electrical shock
- ◆ Engines, pulleys, drive belts, and other hazardous moving parts, if located within 6 feet of floor level, guarded with a safety shield or barrier
- ◆ Fire extinguisher located near the boiler
- ◆ First aid kit located near moving machinery
- ◆ Hard hats for workers and visitors **must** be worn in the treatment and loading areas (optional if not required by local regulations)
- ◆ Steam and hot water pipes insulated or otherwise protected
- ◆ Sufficient lighting provided in working areas

Work Plan

A Work Plan is a formal agreement signed by a representative of each treatment facility in a particular country, the Agriculture Ministry of the host government, and by USDA-APHIS. Work Plans govern the day-to-day operations of each facility and can be improved from one year to the next. Work Plans usually contain additional provisions not included in this checklist.

Fruit exporters are required to operate under general APHIS monitoring and to be in full compliance with all APHIS regulations as outlined in detail in the current Work Plan. The operator of the facility, as well as the inspector assigned to the facility, should each keep a copy available to resolve any disputes.

Plant Material Not Tolerant to Fumigation

Propagative material may be free from visible pests, but certain pathogens may cause undetectable symptoms.

Hot water dip treatment (52 °C/125.6 °F for 30 minutes), combined with hand removal of visible pests is effective against numerous pests. See [T201-p-4 Plant Material Not Tolerant to Fumigation](#) on page 5-3-21 for a list of pests controlled.

Operational procedures and equipment specifications are under development.

Address for Technical Contact

USDA-APHIS-PPQ-S&T-TMT

13601 Old Cutler Road, Bldg. 63

Miami, FL 33158 USA

Phone: 305-278-4877

Fax: 305-278-4898

email: ppqtmt@usda.gov

Nonchemical Treatments

Heat – Steam Treatments

Contents

Principle	3-4-1
Steam Pressure Sterilization	3-4-1
Loose Masses of Material	3-4-2
Closely Packed Material	3-4-2
Steam Jet Method	3-4-3

Principle

Steam at a temperature of 212 °F will destroy most pathogenic microorganisms of the common vegetative forms or the spore types when in the growing or vegetative state in a short period of exposure. Some spores, however, are much more resistant and will withstand prolonged periods of exposure to steam at atmospheric pressure. Saturated steam at temperatures of 240 °F to 248 °F (10 to 15 lbs. pure steam pressure) will destroy the most resistant spores in a brief interval of exposure. However, near-complete air discharge from the autoclave or steam chamber is necessary. When steam is admitted to a chamber from which the air is completely evacuated, the temperature of the steam throughout the chamber will advance at once to the maximum range that can be attained for the pressure carried. If air remains in the chamber, the ultimate temperature will be reduced dependent upon the quantity of air remaining. Refer to a recording or indicating thermometer for correct chamber temperature-pressure relationships.

Detailed operational procedures and equipment specifications are under development.

Steam Pressure Sterilization

Live steam is introduced into a closed chamber containing the material to be treated until the required temperature and pressure are indicated. The temperature/pressure relationship is maintained at or above this point for the required exposure period. The exposure period will depend on the nature of the material, quantity, and its penetrable condition.

Loose Masses of Material

For loose masses of material, which permit rapid and complete penetration of steam to all parts of the mass, no initial vacuum is needed, but air must be released until steam vapor escapes, and exposure at 20 pounds pressure for 10 minutes, 15 pounds for 15 minutes, or 10 pounds for 20 minutes is sufficient.

Closely Packed Material

For closely packed material, such as soil or baled straw, special measures are needed to ensure rapid heat penetration to all parts of the material. Baled rice straw, for example, is required to have a density of less than 30 pounds per cubic foot since penetration at higher densities is too slow to be practical. Soil, if in large containers, will **not** allow adequate treatment under normal sterilization exposure periods. Quicker penetration of the steam is obtained by first exhausting the air in the chamber to a high vacuum and then introducing live steam until the required positive pressure is reached.

Examples of the pressure-temperature relationships are listed in [Table 3-4-1](#). The gauge pressure in pounds per square inch corresponds to the temperature of saturated steam in degrees Fahrenheit. Zero gauge pressure corresponds to an absolute pressure of 14.7 pounds per square inch. The figures are based upon the complete replacement of air by steam. If air replacement is **not** complete, the temperature for any given pressure will be less than the corresponding temperature.

Table 3-4-1 Pressure Temperature Relationships

Gauge Pressure (lbs. per sq. in.)	Temperature °F
10	239.4
15	249.8
20	258.8
30	274.1
40	286.7
50	297.7
60	307.4

Steam Jet Method

Live steam from a jet or nozzle is forced into or through a more or less loose and open mass of material in such amount and for such period required to raise the temperature of all parts of the mass to approximately 212 °F. This method takes advantage of the considerable latent heat liberated when steam condenses into water. This process does **not** effect complete sterilization since spore-forming bacteria are **not** always destroyed. Since **no** spore-forming bacteria are known that cause plant diseases, however, and fungi are readily killed by the temperatures reached, this process is effective for quarantine purposes if the necessary degree of heat is generated in all parts of the material.

Nonchemical Treatments

Heat – Vapor Heat and Forced Hot Air

Contents

Introduction	3-5-1
Procedures	3-5-2
Pretreatment	3-5-2
Loading	3-5-3
Conducting the Treatment	3-5-3
Verifying the Treatment	3-5-3
Post-Treatment Handling	3-5-4
Record Keeping	3-5-4
Common Problems and Failure Points	3-5-5

Introduction

Vapor Heat (VH) and Forced Hot Air (FHA) treatments use heated air to warm fruit to temperatures that are lethal to target pests, primarily fruit flies. Generally, VH treatment differs from FHA only in the relative humidity of the air in the treatment chamber; higher humidity levels may preserve fruit quality. Unless otherwise noted, information in this chapter applies to both VH and FHA treatments for fruits and vegetables.

Each treatment facility is encouraged to develop automated data collection systems designed to automate treatment tracking and ensure that treatment specifications are met.

This chapter describes processes for routine (commercial) treatments for fresh fruits and vegetables at VH and FHA facilities. See [Certification of Forced Hot Air and Vapor Heat Treatment Facilities](#) on page 6-7-1 for VH and FHA certification and equipment requirements.

VH treatment schedules can be found in [T106—Vapor Heat](#) on page 5-2-84. FHA treatment schedules can be found in [T103—High Temperature Forced Air](#) on page 5-2-69.

Procedures

Before any treatments are conducted at a facility, the authorized PPQ official or APHIS designated representative should familiarize themselves with the facility and the way the chamber functions. The official should also carefully review the treatment schedule for the commodity(ies) that will be treated, and any special requirements specified during certification, in the work plan, or in the compliance agreement. The PPQ official or APHIS designated representative approving the facility has the option to increase the number of permanent temperature sensors based on testing performed at the facility.

Pretreatment

Prior to treatment, the PPQ official or APHIS designated representative **must** ensure that the facility and the chamber are in good working order and the temperature sensors are functioning properly. For the purposes of this chapter, the term “sensors” will refer to both permanent and portable temperature sensors. Conduct a brief facility inspection, including chamber and equipment, before any other steps in the treatment process are taken. During this inspection, the official verifies that all safeguarding and quarantine measures are in place and that there are **no** obvious problems that may affect the treatment. If any deficiencies are found, correct them prior to treatment. After the inspection, the official will assist facility personnel in the calibration of the temperature sensors. See [Calibrating the Sensors](#) on page 6-7-4 for calibration procedures.

Before treatment, the official ensures that the commodity meets the requirements specified in this manual, the certification conditions, the work plan, and/or the compliance agreement. These requirements generally include:

- ◆ **Fruit size and weight requirements:** Verify the process and/or equipment used to sort the fruit by measuring or weighing the fruit that is to be treated. Weigh and measure the largest fruit per treatment lot. If fruit are found that do **not** meet the size and weight requirements, evaluate the sorting process and/or equipment and resort the fruit.
- ◆ **Fruit pulp temperature:** There are **no** specific pretreatment fruit pulp temperature requirements. However, the temperature of the fruit pulps within the treatment lot should **not** vary by more than 3.0 °C (5.0 °F). The PPQ official verifies that the pulp temperatures meet this requirement prior to treatment.
- ◆ **Pest inspection:** The PPQ official conducts pest inspections required by the work plan and/or compliance agreement.

Loading

Load the fruit into containers (crates, lugs, or bins) according to the requirements in the certification conditions or work plan. Generally, these requirements will indicate whether or not the fruit must be sorted and the volume of fruit allowed in each container.

Load the containers onto pallets or into cabinets according to the requirements in the certification conditions or work plan. These requirements may specify that containers with larger fruit **must** be located in the colder areas of the stack, or that certain layers of containers are left empty when partial loads are treated.

The sensors are placed in the largest fruit in the treatment lot as it is being loaded into the containers. Insert the tip of the sensor into an area of the fruit pulp that will take the longest to reach treatment temperature. The PPQ official or APHIS designated representative monitors the placement of the sensors and verifies that the probes are placed in the locations required by the certification conditions.

Conducting the Treatment

After all the fruit is loaded into the containers and onto the pallets, and the sensors are properly installed into the heaviest fruit, load the fruit into the chamber. Close and lock the chamber doors to prevent accidental openings. The PPQ official or APHIS designated representative (and the NPPO official, if required by the work plan or compliance agreement) must initial the treatment temperature record and the chamber operator can then initiate the treatment.

During the treatment, the PPQ official or APHIS designated representative **must** monitor the sensor data to ensure the treatment is proceeding in the approved manner. The official must also check the chamber for leaks or other problems during the treatment.

Verifying the Treatment

The PPQ official or APHIS designated representative **must** review the treatment temperature record after the treatment is complete. The official **must** ensure that the temperature and recording interval requirements have been met. Additionally, the official **must** verify that the requirements for the duration of the run up and dwell times are conducted according to the treatment schedule. Time requirements for the run up and dwell times are continuous. Once the official determines that all the treatment requirements are met, the official **must** sign and date the treatment record.

Important Treatment Terminology

The following terms are referred to in the treatment schedules:

- ◆ **Heat up time:** the minimum time allowed for all the temperature probes to reach the prescribed minimum pulp temperature (may also be referred to as the approach or run-up time)
- ◆ **Heat up recording interval:** the time interval required for recording temperatures during the heat up time
- ◆ **Minimum air temperature:** the minimum temperature required for the air in the chamber
- ◆ **Minimum pulp temperature at end of heat up:** the minimum temperature required for all fruit pulp temperature probes
- ◆ **Dwell time:** the length of time all pulp temperature probes must maintain the minimum pulp temperature
- ◆ **Dwell recording interval:** the time interval required for recording temperatures during the dwell time
- ◆ **Cooling method:** optional and may be either hydrocooled or air cooled

Table 3-5-1 Example of a Treatment Schedule

Heat Up Time:	4 hours
Heat Up Recording Interval:	5 minutes
Minimum Air Temperature:	N/A
Minimum Pulp Temperature at End of Heat Up:	47.2 °C/117.0 °F
Dwell Time:	5 minutes
Dwell Recording Interval:	5 minutes
Cooling Method:	Forced air or Hydrocooled

NOTICE

“N/A” in any of the requirements in the Treatment Schedule indicates that PPQ has **no** requirement.

Post-Treatment Handling

After the treatment is complete, move the fruit from the chamber into the quarantine area. Cool the fruit according to the requirements listed in the treatment schedule.

Record Keeping

Keep all treatment records at the treatment facility for 1 year after treatment. The facility **must** also maintain a record of all problems and/or breakdowns, and any maintenance performed on the chamber. All the records listed above **must** be made available to the PPQ official upon request.

Common Problems and Failure Points

If the temperature recording intervals and minimum temperature requirements are **not** met, the treatment fails. The **only** exception to this is that a sensor may record **no** data for a single recording interval during the treatment. (Note: This does **not** mean the temperature may be out of range, **only** that the data may be missing.) After reviewing the treatment data, the official should sign and date the data.

If a problem arises during treatment, such as a sensor stops recording data, records above other sensors, appears to be broken, or if the temperature drops below the required temperature, the following actions **must** be taken:

- ◆ After the treatment is complete, test the sensor according to calibration procedures.
 - ❖ If the sensor passes calibration, then there was a problem with the treatment. **FAIL** the treatment.
 - ❖ If the sensor fails calibration, then there was a problem with the sensor. **PASS** the treatment. If there is more than one failed sensor, then fail the treatment.

The facility manager must determine if the fruit will be re-treated or will be removed from the chamber into the non-quarantine area.

Nonchemical Treatments

Heat – Forced Hot Air – Niger Seed

Contents

Heat Treatment of Niger Seed (<i>Guizotia abyssinica</i>)	3-6-1
Minimum Requirements for Heat Treatment Facilities	3-6-1
Treatment Requirements	3-6-2
Documentation Requirements	3-6-2
Sanitation and Pest Control	3-6-2
The Plant and Warehouse Premises	3-6-2
Containers and Packaging	3-6-2
Waste Disposal	3-6-2
Post Treatment Requirements	3-6-2

Heat Treatment of Niger Seed (*Guizotia abyssinica*)

Niger seed is imported into the United States for bird feed and is frequently contaminated with Federal noxious weed seeds. In order to devitalize the weed seeds, the Niger seed is required to undergo heat treatment in accordance with T412 treatment schedule. Conduct the heat treatment in a foreign or domestic APHIS-certified treatment facility.

Minimum Requirements for Heat Treatment Facilities

If the facility is located in the United States, it **must** be constructed near the port environs (10 miles or less). The facility and equipment **must** adhere to the following requirements:

- ◆ All facilities **must** comply with treatment schedule T412-a in this Treatment Manual. See [Certification of Niger seed Treatment Facilities](#) on page 6-6-1 for certification guidelines.
- ◆ All facilities **must** possess a current work plan or compliance agreement.
- ◆ Facility operators or managers **must** record the following information on each treatment recorder printout:
 - ❖ Date
 - ❖ Lot number
 - ❖ Operator signature

Treatment Requirements

The Niger seed heat treatment schedule requires the seed be treated for a minimum of 15 minutes at 248 °F/120 °C. Determine if the treatment standards are met using the following guidance:

- ◆ Examine treatment recorder printout for completion of treatment and verify that the Niger seed was kept at the target temperature for the required time.
- ◆ If records indicate that any temperature reading fell below 248 °F/120 °C for 15 minutes, nullify the treatment for that specific lot, correct the reason for the faulty treatment, and re-treat the seed.

Documentation Requirements

- ◆ Maintain a log book of all Niger seed treatments.
- ◆ Maintain records of equipment breakdowns and repairs, changes, or modifications to the treatment process, facility, and/or equipment.

Sanitation and Pest Control

The Plant and Warehouse Premises

Require the facility manager to ensure that there is a cleaning and control program in the plant and/or warehouse, and that there are **no** potential breeding grounds for pests on the premises.

Containers and Packaging

Require the facility manager to ensure that seed containers and/or packaging, whether used or new, is checked and cleaned for pests so that the packages are **not** a source of pests and contamination.

Waste Disposal

To minimize contamination risk and eliminate pest breeding sites, require the facility manager to implement a regular waste program for waste and nonconforming or infested produce.

Post Treatment Requirements

After treatment and cooling, immediately place the Niger seed in new bags or in a storage area only for treated seed. Dispose of the original bags in a manner that will eliminate regulated pests. PPQ will:

- ◆ Sample treated seeds for actionable contaminants according to guidelines in the work plan or compliance agreement, or by conducting random inspections and TZ (tetrazolium) tests as needed at the port of entry.

- ◆ Label each treated sample with the following information:
 - ❖ Bill of lading number
 - ❖ Container and lot number
 - ❖ Date the sample was taken
 - ❖ Date the seeds were treated
 - ❖ Origin of seed
 - ❖ Vessel name and nationality
- ◆ Send the sample to an APHIS-approved testing facility

When the laboratory results are available, send the results with the information above to the address identified on the work plan or compliance agreement.

Nonchemical Treatments

Cold Treatment (CT)

Contents

Intransit Cold Treatment in Conventional Vessels, Self-Refrigerated (Integral) Containers, and Warehouses	3-7-2
Packaging—Pallet Covers	3-7-2
Precooling Procedures	3-7-2
Initiating Intransit Cold Treatment in Vessels and Containers	3-7-3
Verification of Temperature Recording Equipment	3-7-3
Calibration of Temperature Sensors	3-7-4
Loading of Commodity in Conventional Vessels and Self-Refrigerated (Integral) Containers—General	3-7-6
Conventional Vessels	3-7-8
Placement of Temperature Sensors	3-7-8
Self-Refrigerated (Integral) Containers	3-7-9
Secure the Load	3-7-10
Treatment Requirements	3-7-11
Prepare Documents	3-7-11
Distribution of Documents	3-7-11
Clearance of Cold Treated Consignments	3-7-12
Conventional Vessels	3-7-12
PPQ Form 556, InTransit Cold Treatment Report	3-7-13
Cold Treatment in Refrigerated Warehouses	3-7-16
Initiating the Cold Treatment	3-7-16
Placement of Temperature Sensors	3-7-17
Quick Freeze Guidelines	3-7-17
Contact Information	3-7-18

Intransit Cold Treatment in Conventional Vessels, Self-Refrigerated (Integral) Containers, and Warehouses

The use of sustained cold temperatures as a means of insect control has been employed for many years. Rigid adherence to specified temperatures and time periods effectively eliminates certain insect infestations. Treatments may be conducted in warehouses, refrigerated compartments of transporting vessels (Conventional Vessels), containers cooled by the ship's refrigeration system (Container Vessels), or by individually refrigerated containers (Self-Refrigerated/Integral Containers). Information concerning conventional vessels, self-refrigerated containers, and warehouses is found in this chapter.

Only certified USDA representatives have permission to conduct warehouse, vessel, and/or container approval tests under the general guidance of [USDA-APHIS-PPQ-S&T-TMT](#). Refer to the [S&T Intransit Cold Treatment website](#) for information regarding the testing of specific vessels and/or containers.

Packaging—Pallet Covers

If the pallet is covered, the pallet cover must be approved by S&T. *See* [Packaging—USDA-Approved For Cold Treatment](#) on page E-30 for a list of APHIS-approved cold treatment pallet covers. Contact ppqmt@usda.gov for approval specifications.

Precooling Procedures

Experience with intransit cold treatments and Computational Fluid Dynamics (CFD) modeling of refrigerated vessel compartments show that the fruit **must** be precooled at or below the prescribed cold treatment temperature before loading. Otherwise, a large quantity of fruit in the middle of large pallet groups may require a week or more to reach the cold treatment temperature.

Fruit intended for intransit cold treatment **must** be precooled to the temperature at which the fruit will be treated prior to beginning treatment.

NOTICE

The precooling process **cannot** be conducted in the intransit cold treatment conveyance unless authorized by the Executive Director of USDA-APHIS-PPQ Plant Health Programs.

Conduct random fruit pulp sampling in the precooling location prior to loading in order to verify that the commodity has completed precooling.

Use the following general guidelines for fruit pulp sampling in the precooling location:

- ◆ Pulp temperatures will be taken by personnel authorized by APHIS, which includes industry representatives
- ◆ Take pulp temperatures by probing the fruit on the periphery of the pallet
 - ❖ If pulp temperatures are 0.28 °C (0.5 °F) or more above the temperature at which the fruit will be treated, the pallet will remain in the precooling location for further precooling

Also, sample fruit pulp temperatures **immediately** before the fruit is loaded on the intransit cold treatment conveyance. Take fruit pulp temperatures by probing fruit in the top of the pallet. An official authorized by APHIS will sample the fruit pulp temperatures in all sections of the load to verify temperatures have **not** risen appreciably. If the pulp temperatures for the sample are 0.28 °C (0.5 °F) or more above the temperature at which the fruit will be treated, the pallet will be rejected and returned to the precooling location for further precooling until the fruit reaches the treatment temperature.

Initiating Intransit Cold Treatment in Vessels and Containers

For cold treatments conducted in approved vessels and containers, the ship's officers will have already received instructions on the APHIS requirements from their owners. However, a discussion by the authorized APHIS official with these individuals will provide for better understanding and cooperation. Such a discussion should include:

- ◆ General treatment procedures in accordance with 7CFR 305.6
- ◆ Stowage arrangement
- ◆ Temperature sensor and instrument calibration testing
- ◆ Treatment conditions

Ensure that there is an adequate communication system in place between personnel in the compartments and the recording room.

Verification of Temperature Recording Equipment

Approved vessels and containers **must** be capable of maintaining fruit pulp temperatures within the specified CT schedules. To monitor these treatments, they **must** be equipped with a temperature recording device which meets the approval of [USDA-APHIS-PPQ-S&T-TMT](#). All approved temperature recording devices **must** be password protected and tamper proof and have the ability to record the date, time, sensor number, and temperature during all calibrations and actual treatments.

If APHIS determines that the records and calibrations can be manipulated, the vessel and/or container will be suspended from conducting cold treatments until proper equipment is installed. Submit any changes to the temperature recording and monitoring equipment to [USDA-APHIS-PPQ-S&T-TMT](#) for approval before installation in the vessel or container. Compare the existing equipment with the equipment listed at <https://treatments.cphst.org/vessels/> to determine if new equipment has been installed that was **not** approved by S&T-TMT.

Specifications for temperature recording installations and other requirements for approval are discussed in [Certification of Cold Treatment](#) on page 6-4-1. Refer to [Appendix E](#) for a list of approved temperature recorders.

Strip Chart Recorder

NOTICE

Since December 31, 2005, strip chart recorders were **no** longer acceptable temperature recording devices. Consequently, by December 31, 2008, there should be **no** strip chart recorders in use for APHIS cold treatment.

Contact [USDA-APHIS-PPQ-S&T-TMT](#) for approved temperature recording instrumentation.

Data Logger

A sufficient supply of log sheets **must** be available to provide a continuous record of calibration and treatment temperatures. The instrument should be in operation for at least 30 minutes prior to calibration tests. Examine a completed log sheet printout and the functioning of the visual scanner, the printer, and the high limit setting. Check the log sheets for proper format and serialization. Activate the temperature set-point for an alarm printout to verify that this function is operational.

NOTICE

Data logger installations are utilized to record various components of the vessel's operating systems. Temperature recording is **only** a part of the record produced. Under S&T-TMT approval requirements, the log sheets upon which the intransit cold treatment is recorded are generally more detailed in design than the standard commercial log sheet. They are prepared and serialized to facilitate scanning and to provide a level of security against fraudulent records. The USDA log should be printed on separate sheets with **no** other ship data interspersed. Data loggers are programmed to print out the temperatures above a set limit in a contrasting color. Some instruments print a symbol to indicate this. The limit is set at the time of loading to a temperature level that coincides with the projected treatment schedule.

Calibration of Temperature Sensors

Calibrate all air and pulp temperature sensors in a clean ice water slurry mixture that is at 0 °C (32 °F), the freezing/melting point of fresh water.

1. Check individual sensors to verify that they are properly labeled and correctly connected to the temperature recorder. This can be accomplished by hand warming each sensor when its number appears on the visual display panel of the recording instrument. A temperature change, which can be observed on the instrument, should occur. If the instrument fails to react, the sensor is incorrectly connected or malfunctioning and should be corrected by the instrument representative.
2. Prepare a mixture of clean ice and fresh water in a clean insulated container.
3. Crush or chip the ice to completely fill the container.
4. Add enough water to stir the mixture.
5. Stir the ice and water for a minimum of 2 minutes to ensure the water is completely cooled and good mixing has occurred.
 - ❖ Generally, the ice will occupy approximately 85 percent of the total volume of the container, with the water occupying the remaining space.
6. Add more ice as the ice melts.
7. Stir the ice water slurry to maintain a temperature of 0 °C (32 °F).
8. Submerge the sensors in the ice water slurry **without** touching the sides or bottom of the container.
9. Stir the slurry mixture again.
10. Continue testing of each sensor in the ice water slurry until the temperature reading stabilizes.
11. Allow at least a 1-minute interval between two consecutive readings for any one sensor; however, the interval **cannot** exceed 5 minutes.
 - ❖ The difference between the two readings **cannot** exceed 0.1 °C.
12. Record at least two consecutive readings on a written calibration report. If the two readings are different, test the sensors again and record the temperature.
13. Contact an instrument company representative immediately if the time interval exceeds the normal amount of time required to verify the reading and accuracy of the sensor and recorder system.
 - ❖ The recorder used with the sensors **must** be capable of printing or displaying on demand and **not** just at hourly intervals.
14. Have the instrument company representative correct any deficiencies in the equipment before certification.
15. Replace any sensor that reads more than +/- 0.3 °C (0.5 °F) from the standard 0 °C (32 °F).

16. Replace and recalibrate any sensors that malfunction.
17. Determine the calibration factors to the nearest tenth of 1 degree Celsius.
18. If the temperature recorder microprocessor can be zeroed, tared, or if the calibration factors can be otherwise entered into the recorder microprocessor for automatic adjustment, this **must** be done. In this case, verify that the adjustment factors have been entered or that the recorder was zeroed or tared by the instrument company representative. Enter zero as the calibration factor for each individual probe in the [online 556 database <https://treatments.cphst.org/>](https://treatments.cphst.org/) (if the database is **not** used, then enter zero for each individual probe in the written calibration report that is submitted with the consignment).
19. If the temperature recorder microprocessor **cannot** be zeroed, tared, or if the calibration factors **cannot** be entered into the recorder microprocessor memory (so that they are sustained in memory and can be viewed again after all the factors are entered), the calibration factors for each individual probe **must** be recorded in the [online 556 database <https://treatments.cphst.org/>](https://treatments.cphst.org/) (if the database is **not** used, then enter the calibration factors for each individual probe on the written calibration report that is submitted with the consignment).
20. After the calibration factors have been accounted for, no other changes should be made to the temperature recorder microprocessor.
21. Refer to the section on [Clearance of Cold Treated Consignments](#) for complete instructions on entering data into the Form 556 or preparing written calibration reports.

Loading of Commodity in Conventional Vessels and Self-Refrigerated (Integral) Containers—General

NOTICE

In countries with which USDA-APHIS has a cooperative agreement, these activities can be conducted by qualified officials from that country. Contact the [USDA-APHIS-PPQ-S&T-TMT](#) for a list of qualified officials.

1. Each compartment or container **must** contain only one type of fruit loaded in one type of carton.
2. Load fruit directly from the precooling area so fruit temperatures do **not** rise significantly after loading and during the transfer of the container to the vessel.
3. Open the cartons in which the sensors will be located and insert the sensors well into the fruit ([Figure 3-7-1](#)). The tip of the sensor **must not** extend through the fruit.

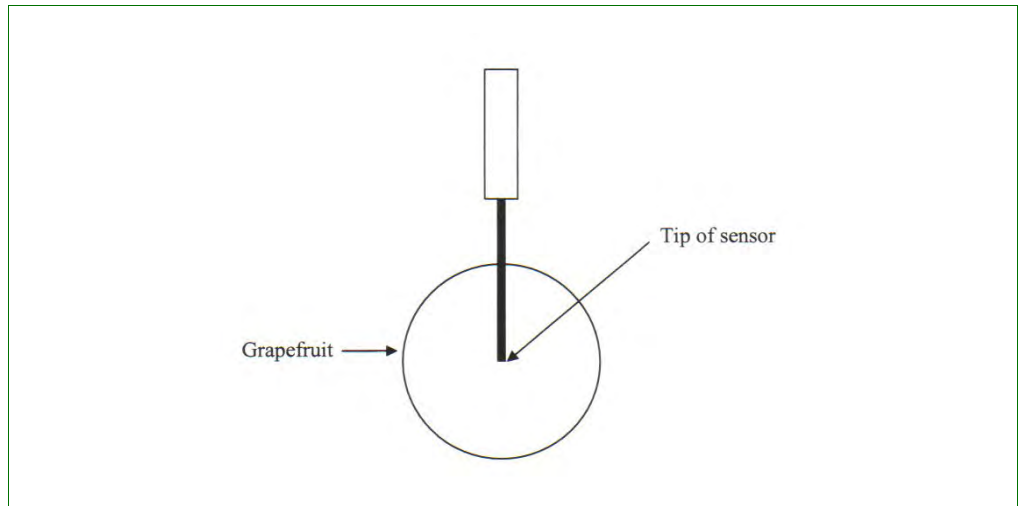

Figure 3-7-1 Proper Placement of Pulp Sensor within Larger Fruit

In the case of small fruit, cover a minimum of two thirds of the tip of the sensor using multiple fruit. If, for example, the fruit is grapes, insert the sensor directly into the grapes in a shish kebob fashion (Figure 3-7-2). Completely cover the probe with the top layer of fruit in the top of the box or carton located in the middle of the pallet.

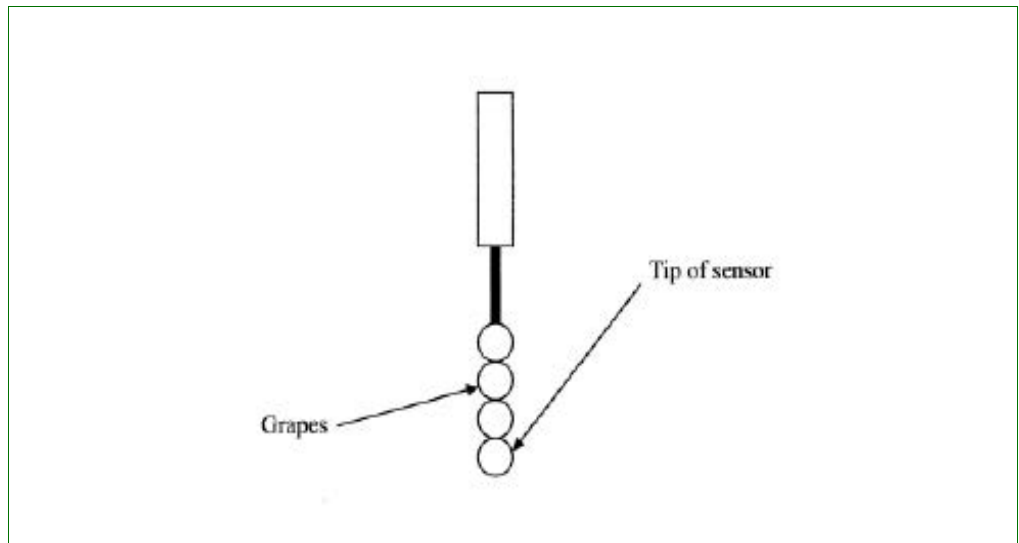

Figure 3-7-2 Proper Placement of Pulp Sensor within Smaller Fruit

4. Securely close the cartons following insertion of the sensors. If the fruit is palletized, it may be necessary to insert the sensor into the fruit from the side of the carton. If the side of the carton or box is opened to insert a sensor, reseal the opened side of the carton or box using tape.

Conventional Vessels

NOTICE

Hanging decks, hatch coamings within vessels, and double-stacking of pallets are not approved for intransit cold treatment. The treatment will **not** begin until all double-stacked pallets are reconfigured into a single-stack pallet arrangement and any pallets located in hanging decks or hatch coamings are removed.

Contact [USDA-APHIS-PPQ-S&T-TMT](#) for more information regarding hatch coamings or hanging decks for particular vessels.

There are two sensor types used for the compartments during cold treatment.

- ◆ Ambient air sensors—the cables which are attached to the ceiling of the compartment should be long enough to extend from the ceiling to the floor. Place the sensors on the center line of the vessel approximately 30 centimeters from the ceiling. Attach the sensors in such a way that they do **not** touch the bulkhead and are protected from damage from the cargo. One sensor **must** be located on the fore and aft bulkheads of each compartment.

In the case of twin deck compartments, two sensors are required in the upper compartment plus one sensor in the lower compartment. Place the lower sensor on the bulkhead furthest from the cooling unit. Ensure that all sensors are readily detachable and stowed in compartments to protect from damage when **not** in use.

- ◆ Fruit pulp sensors—the cables which are attached to the side walls of the compartment **must** be distributed throughout the compartment so that all areas of the compartment can be reached. The cables should be long enough to extend from the hold walls to 3 meters beyond the center line of the ship hold.

Placement of Temperature Sensors

All of the sensors for conventional vessels **must** be located at the mid-level of the pallets as depicted in [Figure 3-7-3](#). The black circles represent pulp sensors.

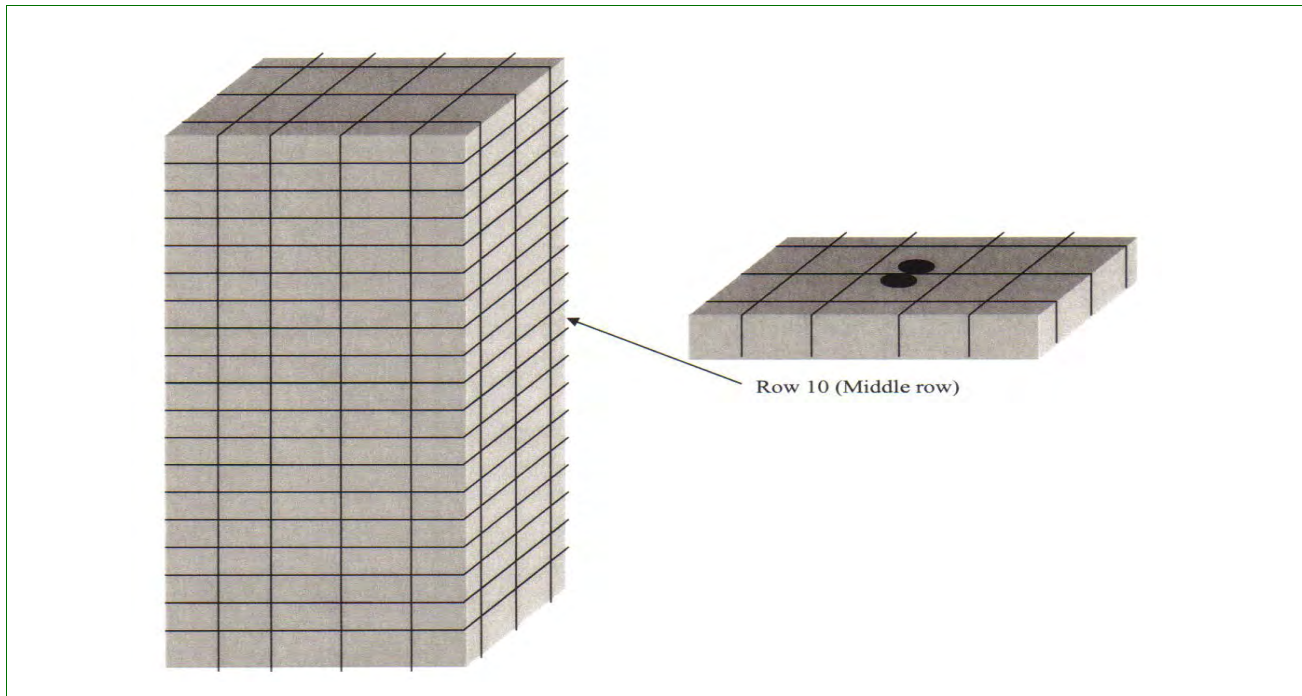

Figure 3-7-3 Fruit Stack with Middle Row Temperature Probe Placement

NOTICE

It is highly recommended that more temperature sensors be installed than the minimum number required for each refrigerated compartment. If a sensor malfunctions during a treatment, the certified USDA representative has the option of disregarding it, providing that an additional working sensor is present, and the functional sensors were appropriately placed, certified, and calibrated. Otherwise, the entire treatment **must** be repeated for the fruit in that compartment.

Self-Refrigerated (Integral) Containers

When loading refrigerated containers, place the warmest fruit in the last quarter of the load (near the back doors of the container), completely cover the floor and ensure that the load is of uniform height.

Place a numbered seal on the loaded container. This **must not** be removed until the load has been cleared at the port of destination.

Use a minimum of three pulp sensors. Place all sensors as far into a box of fruit as possible. Use [Figure 3-7-4](#) as a general guideline for sensor placement.

- ◆ Place the first sensor, labeled USDA1, in a box at the top of the stack of fruit nearest to the air return intake.
- ◆ Place the second sensor, labeled USDA2, slightly aft of the middle of the container, halfway between the top and bottom of the stack.

Nonchemical Treatments *Cold Treatment (CT)*

Loading of Commodity in Conventional Vessels and Self-Refrigerated (Integral) Containers—General

- ◆ Place the third sensor, labeled USDA3, one pallet stack in from the doors of the container, halfway between the top and bottom of the stack.

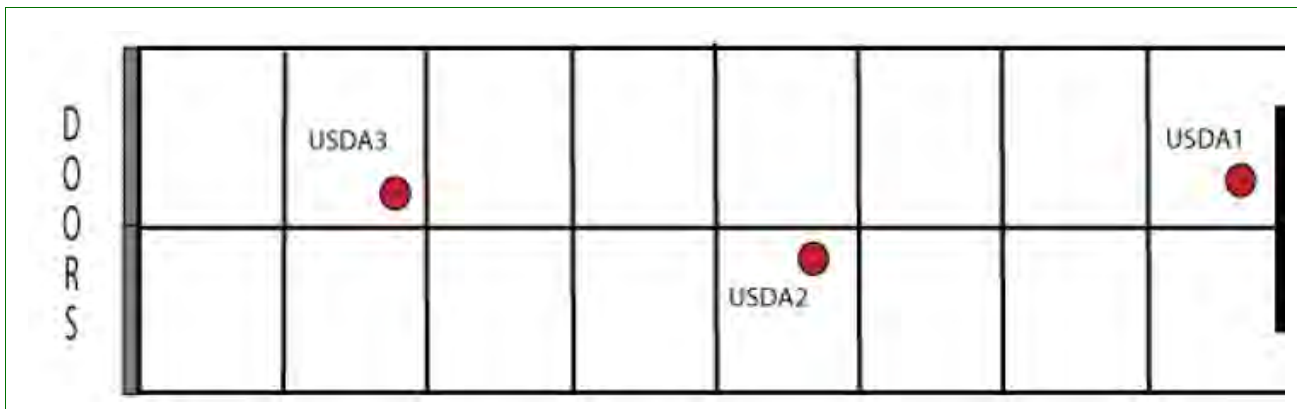

Figure 3-7-4 40-foot Refrigerated Container with 18 Pallets of Fruit (not drawn to scale)

Secure the Load

Place a piece of cardboard that extends from the front edge of the second to last pallet row to the back doors on the container floor before the last pallet row is loaded. Once the cardboard is installed properly, load the last pallet row so the pallets rest on top of the cardboard. Place a second piece of cardboard perpendicular to the first piece of cardboard and staple to the cartons in the last pallet row (Figure 3-7-5). The placement of the cardboard between the back doors of the container and the last row of pallets aids in maximizing air flow through the pallets. Complete this procedure for all pallets in the last pallet row of the container.



Figure 3-7-5 Proper Placement of Cardboard Between the Last Pallet Row of Fruit and the Back Doors of the Container

Treatment Requirements

Temperatures **must** be recorded at intervals **no** longer than 1 hour apart. Gaps of longer than 1 hour may invalidate the treatment or cause treatment failure.

Fruit pulp temperatures **must** be maintained at the temperatures specified in the treatment schedule with no more than **0.39 °C (0.7 °F)** variation in temperature between two consecutive hourly readings. Failure to comply with this requirement may result in treatment failure.

The time required to complete the treatment begins when all temperature probes reach the prescribed treatment schedule temperature.

Prepare Documents

Complete the following PPQ forms and worksheets:

- ◆ “Calibration of Temperature Probes” record showing the temperature readings as taken from the temperature chart or log sheet during the calibration testing. Record readings to the nearest tenth of one degree. When the loading of each compartment has been completed, obtain the temperature reading of each fruit probe from the temperature recorder and record on this form.
- ◆ “Location of Temperature Sensors” record to show the actual position of each fruit temperature sensor. (See sample form in [Appendix A.](#)) This can be accomplished by a written description or by a diagrammatic sketch. Include compartment loading start and end times and dates on the form.
- ◆ PPQ Form 203, Foreign Site Certificate (for APHIS pre-inspected fruit)
- ◆ Shipper’s manifest containing the quantity and kind of commodity

Distribution of Documents

Conventional Vessels and Self-Refrigerated (Integral) Containers

Place the following documents in a sealed envelope and give to the Captain for presentation to the clearance official at the port of arrival.

- ◆ Original “Calibration of Temperature Probes”
- ◆ Original “Location of Temperature Sensors”

For reference purposes, present the Captain with the following documents:

- ◆ Copy of the “Calibration of Temperature Probes”
- ◆ Copy of the “Location of Temperature Sensors”

Send copies of all documents to the clearance official at the port of arrival and to [USDA-APHIS-PPQ-S&T-TMT](#).

Clearance of Cold Treated Consignments

[USDA-APHIS-PPQ-S&T-TMT](#) has developed electronic versions of all required documentation for containerized, intransit cold treatments (**not** vessel). PPQ officials **must** use the 556 Cold Treatment database to clear all containerized, intransit cold treatments. Contact ppqctis@aphis.usda.gov to request access and training.

Off-loading of self-refrigerated containerized fruit that is under treatment **must** be accomplished rapidly. Containers **must** be off-loaded and treatment reconvened within 2 or 3 hours from the time the container was disconnected from the refrigerating unit. The pulp sensors should **never** exceed the maximum allowable treatment temperature.

Observe the stacking pattern. Double stacking is **not** permitted. Do **not** release the consignment if the pallets have been double stacked.

Conventional Vessels

The “Calibration of Temperature Sensors” and “Location of Portable Sensors” documents from the country of origin should have been received at the port of entry prior to the arrival of the carrying vessel.

The document, “Calibration of Temperature Sensors,” is required for all consignments and includes information regarding the loading date and location of temperature sensors within the commodity, as well as calibration correction factors for every sensor.

Refer to the [S&T Intransit Cold Treatment website](#) to familiarize yourself with the compartment layout.

Check the documents and any accompanying correspondence for comments relating to deficiencies noted at origin. The documents **must** bear the signature of an APHIS-approved official or of an authorized official of the exporting country. A list of authorized names and signatures for each country is on file at S&T-TMT and is available upon request.

Inform shipping line officials and pier supervisors of the quarantine safeguards to be observed pending clearance. The authorized APHIS official boarding the vessel **must** have several calibrated thermometers.

PPQ Form 556, InTransit Cold Treatment Report

Complete PPQ Form 556, InTransit Cold Treatment Report. Record the date and time of completion of each compartment and the officer's signature on the temperature chart or log sheet. Do **not** add fruit to the compartment after loading has been completed.

Complete the entries on the PPQ Form 556 during the actual performance of each step of the clearance procedure. The PPQ Form 556 instructions provide for a progressive clearance in the event that treatments are **not** completed before a vessel sails for a second U.S. port.

The Officer responsible for a U.S. vessel is typically the Chief Engineer or Reefer Engineer. The Officer responsible for a Foreign Flag vessel is typically the Chief Officer or Captain.

Inform the ship's officer to withhold discharging the treated commodity until clearance has been completed. Obtain the clearance officer's copy of the calibration documents from the ship's officer (Record in Blocks 1-6 and 10).

Proceed to the data logger with the ship's officer and retrieve a temperature printout.

Review the temperature chart.

NOTICE

If the initial treatment period is broken because of excessive temperatures, failure of the recorder, or improper procedure, and the treatment is later restarted, enter the date and time of restart on the second line of item 28.

Air temperatures may occasionally exceed treatment temperatures during defrost cycles; however, fruit temperatures should **not** rise appreciably during this time and **must not** exceed the temperature listed in the schedule. During non-defrost times, the temperatures of the air sensors should **never** exceed the maximum allowable treatment temperature.

For each compartment of a hold, the hourly sensor printouts will be examined by a PPQ official at the port of entry. Based on these records, the PPQ official will make a determination as to whether to accept the treatment as satisfactory. In case of dispute, the ultimate decision will be made by the Officer in Charge (PPQ), who will take all factors into consideration.

Occasionally, for example, there are cases in which one or two sensors in a compartment mechanically malfunctioned during the voyage due to situations beyond the ship's control (e.g., rough seas). This is generally excusable, as long as the other sensors in the same compartment showed **no** readings higher than the cold treatment schedule allows. If, however, the ship stopped at another port while in route to the discharge destination in the U.S., but failed to have the facility sensor(s) repaired and recalibrated, it may be considered negligence on the part of the shipping line. The fruit from such refrigerated compartments would have to be retreated (in a cold warehouse) to be eligible for entry.

If a sensor is reading consistently high, it should be tested by using the ice water bath technique. If this sensor proves to be accurate (i.e., readings within +/- 0.3 °C from zero) then it **must** be assumed that the high readings obtained in the fruit were indeed accurate, which would be sufficient grounds for rejection. For additional evidence, the PPQ official can also obtain independent fruit pulp readings from a hand-held portable temperature-sensing instrument in the area of the load where high readings were obtained from the ship's sensor(s).

The vessel is permitted to store logged temperatures on magnetic media instead of printed on paper. However, the stored data **must** be printed in the presence of the authorized APHIS official.

Assemble log sheets so that a review can be made starting at the beginning of the temperature record. Check the calibration record; compare the actual calibration readings on log sheets with the calibration data on the calibration document (record in Block 23).

Many data logger installations are programmed to record temperature variations to one-hundredth of a degree centigrade (0.01 °C). With this high resolution of temperature readings, a deviation of up to three-hundredths of a degree can be expected from consecutive readings in a standard ice water test. Accordingly, calibration certifications that are acceptable under our accuracy requirements show either the average of two consecutive calibration readings or two consecutive readings that are within three-hundredths of a degree centigrade of each other. Report deviations beyond this standard.

Review the log sheets up to when the loading of the compartment was complete. Determine the maximum and minimum fruit temperature at the time the sensors were inserted (record in Blocks 24, 25, and 26).

Continue reviewing the log sheets through the precooling period to the time when treatment commenced. Note abnormalities in the temperature readings that could indicate an irregularity in the treatment process (record in Block 27).

Review the treatment portion of the log sheets for irregularities and excessive temperatures (record in Block 28).

NOTICE

If the initial treatment period is broken because of excessive temperatures, failure of the data logger, or improper procedure, and the treatment is later restarted, enter the date and time of restart on the second line of item 28.

Clearance Action by Authorized APHIS Official

The authorized APHIS official will:

- ◆ Hold shipment pending further evaluation if total effects of irregularities are **not** consistent with treatment requirements. Contact the supervisor regarding the reasons for holding the consignment.
- ◆ Record all exceptions in the narrative form and attach to the clearance report.
- ◆ Release consignment for discharge if all requirements have been met and notify ship's officers, pier superintendents, and Customs and Border Protection Agriculture Specialist(s).

Inspection of Load and Compartments

Time permitting, examine the load and compartments during and after unloading. Observe sensor locations, labeling, and physical condition and report irregularities.

Distribution of Clearance Documents

After final clearance, the completed PPQ Form 556 with supporting documents are to be distributed as follows:

- ◆ Keep copies of the PPQ Form 556 and the chart printouts at the port of arrival.
- ◆ Send copies of the PPQ Form 556 to [USDA-APHIS-PPQ-S&T-TMT](#).

Cold Treatment in Refrigerated Warehouses

The warehouse **must** be approved by PPQ (see [Certifying Facilities](#)).

The consignment **must** move directly from the port of entry to the cold storage warehouse with **no** diversion or delay.

The warehouse **must** provide the necessary security for safeguarding each consignment.

The unloading of containers which arrive at the warehouse under seal **must** be conducted under PPQ supervision.

Initiating the Cold Treatment

The procedures for the verification of recording equipment and calibration of temperature sensors are the same as those outlined for vessels in [Intransit Cold Treatment in Conventional Vessels, Self-Refrigerated \(Integral\) Containers, and Warehouses](#) on page 3-7-2, [Initiating Intransit Cold Treatment in Vessels and Containers](#) on page 3-7-3, [Verification of Temperature Recording Equipment](#) on page 3-7-3, and [Calibration of Temperature Sensors](#) on page 3-7-4. These activities **must** be performed under the direction of an authorized APHIS official.

Arrange stowage to provide for adequate air distribution throughout the consignment, and to allow for the sampling of pulp temperatures in any desired location. To accomplish this, leave aisles between rows of pallets, with the aisles parallel to the air flow. Allow space between pallets. Double stacking of pallets is **not** allowed; therefore treatments will **not** begin until pallets are reconfigured to a single stacked pallet arrangement. However, rack systems are acceptable provided they have been approved by S&T-TMT.

Placement of Temperature Sensors

After loading is completed, take fruit temperatures at various locations throughout the load to determine the location of the warmest fruit. Place temperature sensors throughout the load, being sure to place sensors in the warmest areas. Under some conditions, additional air circulation will be required to cool the consignment uniformly. The use of additional fans or blowers will depend on the particular circumstances at the time of treatment.

Placement of sensors should be under the direction of an authorized APHIS official. Insert the sensor well into the fruit. The tip of the sensor **must not** extend through the fruit (Figure 3-7-1). If necessary (in the case of small fruit), the sensor should penetrate multiple fruit (Figure 3-7-2). The number and location of the temperature sensors are determined during warehouse certification. (Table 3-7-1)

Table 3-7-1 Number of Sensors in a Warehouse

Cubic Feet	Cubic Meters	Number of Pallets	Number of Air Sensors	Number of Pulp Sensors	Total Number of Sensors
0 - 10,000	0 - 283	1 - 100	1	2	3
10,001 - 20,000	284 - 566	101 - 200	1	3	4
20,001 - 30,000	567 - 849	201 - 300	1	4	5
30,001 - 40,000	850 - 1132	301 - 400	1	5	6
40,001 - 50,000	1133 - 1415	401 - 500	1	6	7
50,001 - 60,000	1416 - 1698	501 - 600	1	7	8
60,001 - 70,000	1699 - 1981	601 - 700	1	8	9
70,001 - 80,000	1982 - 2264	701 - 800	1	9	10
80,001 - 90,000	2265 - 2547	801 - 900	1	10	11
90,001 - 100,000	2548 - 2830	901 - 1000	1	11	12
Over 100,000	> 2830	1000+	Must be approved by S&T-TMT		

Quick Freeze Guidelines

Freezing will ruin the market quality of most fresh fruits and vegetables, except for thick-skinned items such as durian and coconut. Generally, this treatment is used on fruits and vegetables that will be processed into another form (e.g. for puree, juice, or mashed vegetables).

Freezing is an acceptable method of mitigating the pests listed in the schedule. Treatment may result in commodity destruction. APHIS is not liable for damage to the commodity. Importers that choose freezing as a treatment do so at their own risk.

Operational procedures and equipment specifications are under development.

Contact Information

USDA-APHIS-PPQ-S&T-TMT

13601 Old Cutler Road, Bldg. 63

Miami, FL 33158 USA

Phone: 305-278-4877

email: ppqmt@usda.gov

Fax: 305-278-4898

Nonchemical Treatments

Irradiation

Contents

Introduction	3-8-1
Authorities and Other Responsible Parties	3-8-2
Treatment Objectives	3-8-2
Efficacy	3-8-2
Treatment	3-8-3
Dosimetry	3-8-3
Dose Mapping	3-8-4
Facility Approval	3-8-4
Documentation	3-8-4
Terminology	3-8-5

Introduction

This chapter provides background and general information for the use of irradiation as a phytosanitary treatment of plant pests. Irradiation was first approved by APHIS in 1997 for use on papayas from Hawaii for export to the U.S. mainland, Guam, Puerto Rico, and the U.S. Virgin Islands. In 2002, irradiation was approved as a phytosanitary treatment for all admissible fresh fruits and vegetables from all countries.

Authorities and Other Responsible Parties

- ◆ 7CFR 305.31 through 305.9
- ◆ Food and Drug Administration (FDA) — The FDA is responsible for determining the labeling requirements for irradiated food.
- ◆ International Standard for Phytosanitary Measures #18 (ISPM) — This International Standard provides technical guidance on the specific procedures for the application of ionizing radiation as a phytosanitary treatment for regulated pests or articles.
- ◆ National nuclear regulatory authority of the country where the facility is located

Treatment Objectives

The objective of phytosanitary treatments is to prevent the introduction or spread of regulated pests. As a phytosanitary treatment, irradiation may reduce the risk of introduction by achieving certain responses, known as “endpoints,” in the targeted pest(s). These endpoints are:

- ◆ Inability to emerge or fly
- ◆ Inactivation or devitalization (seeds may germinate, but seedlings do **not** grow, or tubers, bulbs, or cuttings do **not** sprout)
- ◆ Mortality
- ◆ Sterility (inability to reproduce)

Efficacy

Unlike the Probit 9 mortality required for many chemical and nonchemical quarantine treatments, the use of irradiation as a phytosanitary measure presents a new paradigm to PPQ. The officer inspecting the treated consignment upon arrival in the U.S. may encounter living insects. However, this is to be expected since the treatment endpoint may **not** necessarily be mortality.

Treatment

There are three types of ionizing radiation:

- ◆ Electrons generated from machine sources up to 10 MeV (eBeam)
- ◆ Radioactive isotopes (gamma rays from cobalt-60 or cesium-137)
- ◆ X-rays (up to 7.5 MeV)

The unit of measure for absorbed dose from any type of radiation is gray (Gy).

Modified atmospheres with low oxygen levels may reduce treatment efficacy at a prescribed dose. Do **not** irradiate commodities that are in packaging or other conditions that cause oxygen levels to be less than 10%. Modified atmosphere packaging **must** be approved by S&T. See [Packaging—USDA-Approved For Modified Atmosphere Irradiation](#) on page E-29 for a list of APHIS-approved modified atmosphere irradiation packaging. Contact ppqmt@usda.gov for approval specifications.

Treatment procedures should also ensure that the minimum absorbed dose (Dmin) is fully attained throughout the commodity to provide the prescribed level of efficacy. Owing to the differences in the configuration of lots being treated, higher doses than the Dmin may be received by some of the commodities to ensure that the Dmin is achieved throughout the configured commodity. All treatments **must** be certified by verifying Dmin with approved dosimetry systems.

The minimum absorbed dose for the most-tolerant unmitigated pest is required if more than one pest is present. Refer to Table 5-2-2 on page 5-2-78 to determine the required minimum absorbed dose. For example, if a consignment of grapes is infested with both Mediterranean fruit fly and codling moth, the commodity would be irradiated using a minimum dose of 200 Gy.

Dosimetry

Dosimetry is the system used by the facility to determine absorbed dose. The absorbed dose is a quantity of radiation energy (measured in Gray (Gy)) absorbed per unit of mass of the commodity.

The dosimetry system should be calibrated in accordance with international standards or appropriate national standards (e.g., Standard ISO/ASTM 51261 *Guide for Selection and Calibration of Dosimetry Systems for Radiation Processing*).

Dose Mapping

Prior to routine treatments, the region(s) of lowest and highest dose absorbance **must** be mapped for each treatment configuration. Configurations may be defined by a variety of criteria which may vary by facility. Factors that affect dose mapping commonly include:

- ◆ Density and composition of the material treated
- ◆ Orientation of the product, stacking, volume, and packaging
- ◆ Shape and/or size

Dose mapping of the product in each geometric packing configuration, arrangement and product density that will be used during routine treatments should be required by APHIS prior to the approval of a facility for the treatment application. Only the configurations approved by APHIS should be used for actual treatments.

The data obtained from the dose mapping is used to determine the proper number and placement of dosimeters during routine operations.

Facility Approval

Chapter 6-8 of this manual, [Certifying Irradiation Treatment Facilities](#), covers the requirements for irradiation facility approval.

Documentation

The tracking and reporting of an irradiation treatment is critical to the integrity of the entire irradiation process. Treatment failure is linked to non-compliance, **not** pest detection. Consequently, an electronic database, Irradiation Reporting and Accountability Database (IRADS) was developed to standardize data entry, accurately and quickly produce data summaries and analysis, and allow access to a geographically diverse group of people. PPQ officials **must** use IRADS to monitor all phytosanitary irradiation treatments. Contact ppqctis@aphis.usda.gov to request access and training.

NOTICE

The Irradiation Reporting and Accountability Database (IRAD) is a component of the [Commodity Treatment Information System \(CTIS\)](https://treatments.cphst.org/) <<https://treatments.cphst.org/>> developed by USDA-APHIS-PPQ-S&T-TMT. Access to this web-based system will be permitted depending on the user's specific role or function in the irradiation process.

Terminology

absorbed dose. quantity of radiation energy (in gray) absorbed per unit of mass of a specified target [ISPM No. 18]

dose mapping. measurement of the absorbed dose distribution within a process load through the use of dosimeters placed at specific locations within the process load [ISPM No. 18]

dosimeter. a device that, when irradiated, exhibits a quantifiable change in some property of the device which can be related to absorbed dose in a given material using appropriate analytical instrumentation and techniques [ISPM No. 18]

dosimetry. a system used for determining absorbed dose, consisting of dosimeters, measurement instruments and their associated reference standards, and procedures for the system's use [ISPM No. 18]

gray (Gy). unit of absorbed dose where 1 Gy is equivalent to the absorption of 1 joule per kilogram ($1 \text{ Gy} = 1 \text{ J.kg}^{-1}$) [ISPM No. 18]

ionizing radiation. charged particles and electromagnetic waves that, as a result of physical interaction, create ions by either primary or secondary processes [ISPM No. 18]

irradiation. treatment with any type of ionizing radiation [ISPM No. 18]

minimum absorbed dose. the localized minimum absorbed dose within the process load [ISPM No. 18] (D_{min})

radura. internationally recognized symbol used to indicate when a food product has been irradiated



Residue Monitoring

Collecting, Packaging, and Shipping

Contents

Overview	4-1-1
Safety	4-1-2
Collecting the Sample	4-1-2
Pretreatment Sample	4-1-2
Post-Treatment Sample	4-1-2
Labeling the Sample	4-1-3
Storing the Sample	4-1-3
Shipping Samples	4-1-3
Quarantine Requirements	4-1-3

Overview

Methyl bromide fumigants, except those with “Q” labels, are subject to requirements of the FIFRA Section 18 Quarantine Exemption. When commodities intended for food or feed are fumigated with methyl bromide under the FIFRA Section 18 Quarantine Exemption, one additional EPA requirement must be met: PPQ must monitor aeration by sampling the gas concentration to determine when a commodity may be released.

NOTICE

Currently, Plant Protection and Quarantine (PPQ) is **not** taking samples of commodities for residue monitoring. However, if residue monitoring becomes necessary, this section provides guidelines for taking samples that will be used for monitoring fumigant residues.

In the past, PPQ used residue monitoring to comply with the Environmental Protection Agency’s (EPA) guidelines for fumigation of edible food or feed products conducted under a Section 18 Quarantine Exemption. PPQ took and analyzed samples of fumigated commodities, and they reported the resulting data yearly to EPA. When a fumigation was conducted under a Section 18 Quarantine Exemption, samples were taken only when the commodity would be eaten by people or fed to animals. When the commodity would **not** be used for food or feed, PPQ did **not** take samples.

For example, if thyme would be used as an herb and fumigated under the schedule (T101-n-2), PPQ would sample the commodity because it would be eaten. On the other hand, if that same thyme were treated but imported as a cut

flower, sampling would **not** be necessary because it would be used for decoration—**not** eating.

Safety

Pretreatment samples will be shipped with dry ice. Be sure to store dry ice in well-ventilated areas and to transport dry ice and samples packed in dry ice in well-ventilated containers. Wear gloves when handling dry ice. For detailed information, see [Safety Data Sheets](#).

The Department of Transportation (DOT) considers dry ice a hazardous material and requires that aircraft record the amount of dry ice carried in the cargo hold. Amounts of 5 pounds or less are **not** stringently regulated; however, include the weight of dry ice on the shipping label. In addition, some overnight delivery companies have restrictions on shipping dry ice. Equip shipping containers with loose-fitting lids to prevent an explosive release of sublimating carbon dioxide. Identify dry ice as ORM-A on the shipping label. Also indicate on the label that the package contains diagnostic specimens.

Collecting the Sample

You must take a sample prior to treatment (pretreatment) and after aeration is completed (post-treatment). To avoid contaminating the sample, handle it as little as possible. Take pretreatment and post-treatment samples from the same general location within a given lot (i.e., the same bags, boxes, or other containers).

Some ports receive commodities several times a month. These shipments need not be sampled each time. For frequently received commodities, ports should develop a routine sample collection plan, such as one sample collected per week. However, when a new commodity is received or a commodity is received infrequently (once a week or less), collect a sample each time the commodity is treated.

Pretreatment Sample

1. Collect a minimum of 450g (approximately 1 lb.), **except** for herbs, of which you need to collect 150 grams (approximately one-third pound). If you are collecting fruits or vegetables that are heavy (for example, grapefruit or yams), be sure to collect at least two pieces of produce that weigh 450g.
2. Place these samples in containers with dry ice.
3. Ship the pretreatment samples separately from post-treatment samples.

Post-Treatment Sample

1. Collect a minimum of 450g (approximately 1 lb.), **except** for herbs, of which you need to collect 150 grams (approximately one-third pound). If you are collecting fruits or vegetables that are heavy (for example, grapefruit or yams), be sure to collect at least two pieces of produce that weigh 450g.
2. Ship the post-treatment samples separately from the pretreatment samples and in accordance with standard shipping practices. If the samples require refrigeration, then ship the samples with wet ice or ice packs. If the samples are normally shipped at ambient temperature (e.g., yams), ship them **without** ice.

Labeling the Sample

Label each sample container with the State, county, date, and name of contents, and whether the sample is “pre” or “post” treatment. For this label, use waterproof ink on a strip of masking tape or other label material. Be sure to attach the label before leaving the sampling site. Securely fasten a plastic envelope containing the yellow copy of the APHIS Form 2061 to the side of the sampling container. Label this envelope with the same information that you placed on the sample container (State, county, date, and name of contents, and whether the sample was “pre” or “post” treatment).

Storing the Sample

Immediately place the samples in a freezer or refrigerator until ready to package the samples for shipping.

Shipping Samples

Quarantine Requirements

Contact the State Plant Health Director to determine where to ship the samples. Ship all samples in leakproof, double sealed containers. Ensure the pretreatment sample is secure since it does **not** meet entry requirements for the United States.

Ship samples in coolers with dry ice packed above the samples. The lid of the cooler should be loose fitting to allow gases to escape. Ship the samples using the contract overnight delivery service, or the U.S. Postal Service overnight delivery.

Treatment Schedules

Index

Contents

T100 - Schedules for Fruits, Nuts, and Vegetables	5-2-1
T200 - Schedules for Propagative Plant Material	5-3-1
T300 - Schedules for Miscellaneous Plant Products	5-4-1
T400 - Schedules for Miscellaneous Products	5-5-1
T500 - Schedules for Plant Pests or Pathogens	5-6-1
T600 - Controlled Atmosphere Temperature Treatment System	5-7-1
D301 - Schedules for Domestic Movement of Regulated Articles	5-8-1

Treatment Schedules

T100 - Schedules for Fruits, Nuts, and Vegetables

Contents

Reporting Commodity Injury	5-2-1
FIFRA Section 18 Exemption	5-2-2
Determine the Correct Label for Fumigation	5-2-2
How Fruits and Vegetables are Listed	5-2-2
T101—Methyl Bromide Fumigation	5-2-3
T102—Water Treatment	5-2-63
T103—High Temperature Forced Air	5-2-69
T104—Pest Specific/Host Variable	5-2-72
T105—Irradiation	5-2-77
T106—Vapor Heat	5-2-84
T107—Cold Treatment	5-2-89
T108—Fumigation Plus Cold Treatment of Fruits	5-2-97
T109—Cold Treatment Plus Fumigation of Fruits	5-2-101
T110—Quick Freeze	5-2-104

Reporting Commodity Injury

Record any new or unusual observations relating to injury of commodity and report them to Quarantine Policy, Analysis and Support (QPAS) in Riverdale. Give pertinent details of the treatment and conditions regarding its application. In appraising the effect of a particular treatment, take care to distinguish between the actual or apparent effects directly attributable to the treatment and those relating to factors or conditions **not** subject to PPQ control.

Commodities in the T100 series are intended for consumption as food or feed. These commodities may have to be treated with methyl bromide to control a pest.

FIFRA Section 18 Exemption

Methyl bromide fumigants, **except** those with “Q” labels, are subject to requirements of the Federal Insecticide, Fungicide, and Rodenticide Act (FIFRA), Section 18 Quarantine Exemption. When commodities intended for food or feed are fumigated with methyl bromide under the FIFRA Section 18 Quarantine Exemption, one additional EPA requirement **must** be met: PPQ **must** monitor aeration by sampling the gas concentration to determine when a commodity may be released.

In this manual, fumigation schedules under the FIFRA Section 18 Quarantine Exemption are identified by the following note:

NOTICE

Do **not** use this treatment schedule if its FIFRA Section 18 Exemption has expired. For the current exemption status, call your local State Plant Health Director (SPHD).

Determine the Correct Label for Fumigation

Always use the label of the fumigant to determine if the commodity can be treated. Fumigation schedules in this publication are intended to clarify and expand commercial labels for methyl bromide. The EPA only authorizes fumigation for commodities that are listed on the label of the gas being used for the fumigation. Also, to comply with State regulations, a fumigant **must** be registered in the State where it is being used.

Although the EPA only authorizes the use of a pesticide on a crop, animal, or site that is listed on the label of a pesticide, specific pests do **not** have to be listed on the label to use the pesticide. An amendment to FIFRA in 1978 permits the use of a pesticide to control a pest **not** on the label if the application is to a crop, animal, or site specified on the label, unless mentioned otherwise.

How Fruits and Vegetables are Listed

Fruits and vegetables that are to be fumigated with methyl bromide (T101s) will be listed in alphabetical order. Each schedule will have an assigned letter, e.g., Apples T101-a-1, Zucchini T101-h-3. For fruits and vegetables that require treatment as a condition of entry, refer to the [Agricultural Commodity Import Requirements \(ACIR\)](#) database for the specific treatment.

T101—Methyl Bromide Fumigation

T101-a-1 Apple and Pear¹

Pest: External feeders

Treatment: T101-a-1—MB at NAP—tarpaulin or chamber

Temperature (°F)	Dosage Rate (lb/1,000 ft ³)	Minimum Concentration Readings (ounces) At:	
		0.5 hr	2 hrs
80 and above	1.5	19	14
70-79	2.0	26	19
60-69	2.5	32	24
50-59	3.0	38	29
40-49	4.0	48	38

T101-a-3 Apricot², Peach, Plum, Nectarine

Pest: External feeders

Treatment: T101-a-3—MB at NAP—tarpaulin or chamber

Temperature (°F)	Dosage Rate (lb/1,000 ft ³)	Minimum Concentration Readings (ounces) At:	
		0.5 hr	2 hrs
80 and above	1.5	19	14
70-79	2.0	26	19
60-69	2.5	32	24
50-59	3.0	38	29
40-49	4.0	48	38

1 Fumigation may cause severe damage to Chinese, Japanese, Asian, and Sand Pears. Obtain the importer's consent before fumigation.

2 Pluots and plumcots are considered hybrids of apricots and plums and can be treated using T101-a-3 provided they are treated as a **Section 18 Crisis Exemption**.

T101-b-1 Asparagus

Pest: External feeders, such as Noctuidae, *Thrips* spp. (**except** *Scirtothrips dorsalis* from Thailand), *Copitarsia* spp.

Treatment: T101-b-1—MB (“Q” label only) at NAP—tarpaulin or chamber

CAUTION

Fumigation may cause damage and a reduction in shelf life. Obtain the importers consent before fumigation.

Temperature (°F)	Dosage Rate (lb./1,000 ft ³)	Minimum Concentration Readings (ounces) At:	
		0.5 hr	2.5 hrs
80 and above	1.5	19	14
70-79	2.0	26	19
60-69	2.5	32	24
50-59	3.0	38	29
40-49	4.0	48	38

NOTICE

Asparagus can be fumigated with T101-b-1 in those states listed in the PPQ 2ee recommendation: California, Florida, Georgia, Illinois, New Jersey, New York, and Pennsylvania. In these states, aeration is the fumigator’s responsibility.

If asparagus is to be fumigated in states **other than** CA, FL, GA, IL, NJ, NY, and PA, contact USDA-APHIS-PPQ at (301) 851-2312 or (301) 851-2243.

T101-b-1-1 Asparagus from Thailand, Australia, and New Zealand

Pest: *Scirtothrips dorsalis* (Thailand), *Halotydeus destructor* (Australia, New Zealand)

Treatment: T101-b-1-1 MB (“Q” label only) at NAP—tarpaulin or chamber

Temperature (°F)	Dosage Rate (lb/1,000 ft ³)	Minimum Concentration Readings (ounces) At:	
		0.5 hr	2 hrs
80 and above	2.5	32	24
70-79	3.0	38	29
60-69	4.0	48	38

T101-c-1 Avocado (from Hawaii, Israel, or the Philippines)

Pest: *Ceratitis capitata* (Mediterranean fruit fly), *Bactrocera dorsalis* (Oriental fruit fly), and *Zeugodacus cucurbitae* (melon fly; formerly known as *Bactrocera cucurbitae*)

Treatment: T101-c-1—MB at NAP—tarpaulin or chamber

CAUTION

Treatment is marginal as to host tolerance. Warn shipper of possible injury.

Alternative: T108 may be used as an alternative treatment.

Temperature (°F)	Dosage Rate (lb/1,000 ft ³)	Minimum Concentration Readings (ounces) At:		
		0.5 hr	2 hrs	4 hrs
70 and above	2.0	26	16	14

NOTICE

Do **not** use this treatment schedule if its FIFRA Section 18 Exemption has expired. For the current exemption status, call your local State Plant Health Director (SPHD).

T101-d-1 Banana

Pest: External feeders such as Noctuidae, *Thrips* spp., *Copitarsia* spp.

Treatment: T101-d-1—MB at NAP—tarpaulin or chamber

CAUTION

Treatment is marginal as to host tolerance. Warn shipper of possible injury.

Temperature (°F)	Dosage Rate (lb/1,000 ft ³)	Minimum Concentration Readings (ounces) At:	
		0.5 hr	2 hrs
80 and above	1.5	19	14
70-79	2.0	26	19
60-69	2.5	32	24
50-59	3.0	38	29
40-49	4.0	48	38

NOTICE

Do **not** use this treatment schedule if its FIFRA Section 18 Exemption has expired. For the current exemption status, call your local State Plant Health Director (SPHD).

T101-e-1 Bean (except Faba Bean), Dry

Pest: Bruchidae (seed beetles)

Treatment: T101-e-1—MB at NAP—tarpaulin or chamber

Temperature (°F)	Dosage Rate (lb/1,000 ft ³)	Minimum Concentration Readings (ounces) At:					
		0.5 hr	2 hrs	2.5 hrs	3 hrs	3.5 hrs	4 hrs
70 and above	3.0	38	–	24	–	–	–
60-69	3.0	38	29	–	24	–	–
50-59	3.0	38	29	–	–	24	–
40-49	3.0	38	29	–	–	–	24

Fresh Beans: See [T101-k-2 Green Pod Vegetables](#) or [T101-n-2-1-1 Dried Herbs, Spices, and Mint \(Mentha spp.\) \(All Plant Parts and Seeds\)](#)

T101-g-1 Beet

Pest: Internal feeders

Treatment: T101-g-1—MB chamber, 15” vacuum—chamber

Temperature (°F)	Dosage Rate (lb/1,000 ft ³)	Exposure Period (hrs)
90 and above	2.0	2
80-89	2.5	2
70-79	3.0	2
60-69	3.0	2.5
50-59	3.0	3
40-49	3.0	3.5

NOTICE

As of October 2008, **no** commercial chambers in the United States are approved for the vacuum fumigation of imported commodities. If vacuum treatment is required as a condition of entry, the consignment **must** be destroyed, reexported, or returned to country of origin.

T101-g-1-1 Beet

Pest: External feeders

Treatment: T101-g-1-1—MB at NAP—tarpaulin or chamber

Temperature (°F)	Dosage Rate (lb/1,000 ft ³)	Minimum Concentration Readings (ounces) At:				
		0.5 hr	2 hrs	3 hrs	3.5 hrs	4 hrs
90 and above	2.0	26	19	19	–	–
80-89	2.5	32	24	24	–	–
70-79	3.0	38	29	24	–	–
60-69	3.0	38	29	–	24	–
50-59	3.0	38	29	–	–	24

T101-h-1 Blackberry

Pest: External feeders such as Noctuidae, *Thrips* spp., *Copitarsia* spp., Pentatomidae, and *Tarsonemus* spp.

Treatment: T101-h-1—MB at NAP—tarpaulin or chamber

Temperature (°F)	Dosage Rate (lb/1,000 ft ³)	Minimum Concentration Readings (ounces) At:	
		0.5 hr	2 hrs
80 and above	1.5	19	14
70-79	2.0	26	19
60-69	2.5	32	24
50-59	3.0	38	29
40-49	4.0	48	38

NOTICE

Do **not** use this treatment schedule if its FIFRA Section 18 Exemption has expired. For the current exemption status, call your local State Plant Health Director (SPHD).

T101-i-1 Blueberry

Pest: External feeders

Treatment: T101-i-1—MB at NAP—tarpaulin or chamber

Temperature (°F)	Dosage Rate (lb/1,000 ft ³)	Minimum Concentration Readings (ounces) At:	
		0.5 hr	2 hrs
80 and above	1.5	19	14
70-79	2.0	26	19

T101-i-1-1 Blueberry

NOTICE

Lobesia botrana (European grapevine moth) has been added to this treatment schedule as the result of an emergency action required by PPQ in order to mitigate the pest risk. The emergency action is an interim measure and is pending final regulatory approval. (Federal Order DA-2014-03 issued January 9, 2014; supersedes previous Federal Order DA-2013-56)

Pest: *Ceratitis capitata* (Mediterranean fruit fly), *Anastrepha fraterculus* (South American fruit fly), and *Lobesia botrana* (European grapevine moth)

Treatment: T101-i-1-1—MB at NAP—tarpaulin or chamber

Temperature (°F)	Dosage Rate (lb/1,000 ft ³)	Minimum Concentration Readings (ounces) At:		
		0.5 hr	2 hrs	3.5 hrs
70 and above	2.0	26	22	21

T101-i-1-2 Blueberry

NOTICE

Lobesia botrana (European grapevine moth) has been added to this treatment schedule as the result of an emergency action required by PPQ in order to mitigate the pest risk. The emergency action is an interim measure and is pending final regulatory approval. (Federal Order DA-2013-56)

Pest: *Ceratitis capitata* (Mediterranean fruit fly), *Anastrepha fraterculus* (South American fruit fly), and *Lobesia botrana* (European grapevine moth)

Treatment: T101-i-1-2—MB at NAP—chamber

Temperature (°F)	Dosage Rate (lb/1,000 ft ³)	Exposure Period (hrs)
60 and above	2.0	3.5

T101-i-1-3 Blueberry

Pest: *Lobesia botrana* (European grapevine moth)

Treatment: T101-i-1-3—MB at NAP—tarpaulin

The yellow and black colors of this schedule indicates that the authority to conduct the treatment comes from an emergency action required by PPQ in order to mitigate the pest risk. (Federal Order DA-2014-03) The emergency action is an interim measure and is pending final regulatory approval.

Fumigate after cold storage (34 °F or lower) for a minimum of 10 days. The cold storage is not subject to verification by PPQ nor CBP and is not a quarantine treatment.

Temperature (°F)	Dosage Rate (lb./1,000 ft ³)	Minimum Concentration Readings (ounces) At:	
		0.5 hr	3 hrs
40-69	4.0	55	45

NOTICE

Do **not** use this treatment schedule if its FIFRA Section 18 Exemption has expired. For the current exemption status, call your local State Plant Health Director (SPHD).

CAUTION

Phytoxicity is unknown. Obtain the importer's consent before fumigation.

T101-i-1-4 Blueberry

Pest: *Lobesia botrana* (European grapevine moth)

Treatment: T101-i-1-4—MB at NAP—chamber

The yellow and black colors of this schedule indicates that the authority to conduct the treatment comes from an emergency action required by PPQ in order to mitigate the pest risk. (Federal Order DA-2014-03) The emergency action is an interim measure and is pending final regulatory approval.

NOTICE

Do **not** use this treatment schedule if its FIFRA Section 18 Exemption has expired. For the current exemption status, call your local State Plant Health Director (SPHD).

⚠ CAUTION

Phytotoxicity is unknown. Obtain the importer's consent before fumigation.

T101-n-2 Broccoli (*Brassica oleracea* var. *botrytis*)

Pest: External feeders and leaf miners

Treatment: T101-n-2—MB at NAP—tarpaulin or chamber

Temperature (°F)	Dosage Rate (lb/1,000 ft ³)	Minimum Concentration Readings (ounces) At:	
		0.5 hr	2 hrs
70 and above	2.0	26	14
60-69	2.5	32	24
50-59	3.0	38	29
45-49	3.5	43	34
40-44	4.0	48	38

NOTICE

Do **not** use this treatment schedule if its FIFRA Section 18 Exemption has expired. For the current exemption status, call your local State Plant Health Director (SPHD).

T101-n-2 Broccoli, Chinese (Gai Lon) (*Brassica oleracea* L. var. *alboglabra*)

Pest: External feeders and leaf miners

Treatment: T101-n-2—MB at NAP—tarpaulin or chamber

Temperature (°F)	Dosage Rate (lb/1,000 ft ³)	Minimum Concentration Readings (ounces) At:	
		0.5 hr	2 hrs
70 and above	2.0	26	14
60-69	2.5	32	24
50-59	3.0	38	29
45-49	3.5	43	34
40-44	4.0	48	38

NOTICE

Do **not** use this treatment schedule if its FIFRA Section 18 Exemption has expired. For the current exemption status, call your local State Plant Health Director (SPHD).

T101-n-2 Broccoli raab (Rapini) (*Brassica rapa* or *B. campestris*)

Pest: External feeders and leaf miners

Treatment: T101-n-2—MB at NAP—tarpaulin or chamber

Temperature (°F)	Dosage Rate (lb/1,000 ft ³)	Minimum Concentration Readings (ounces) At:	
		0.5 hr	2 hrs
70 and above	2.0	26	14
60-69	2.5	32	24
50-59	3.0	38	29
45-49	3.5	43	34
40-44	4.0	48	38

NOTICE

Do **not** use this treatment schedule if its FIFRA Section 18 Exemption has expired. For the current exemption status, call your local State Plant Health Director (SPHD).

T101-n-2 Brussels Sprouts (*Brassica oleracea* var. *gemmifera*)

Pest: External feeders and leaf miners

Treatment: T101-n-2—MB at NAP—tarpaulin or chamber

Temperature (°F)	Dosage Rate (lb/1,000 ft ³)	Minimum Concentration Readings (ounces) At:	
		0.5 hr	2 hrs
70 and above	2.0	26	14
60-69	2.5	32	24
50-59	3.0	38	29
45-49	3.5	43	34
40-44	4.0	48	38

NOTICE

Do **not** use this treatment schedule if its FIFRA Section 18 Exemption has expired. For the current exemption status, call your local State Plant Health Director (SPHD).

T101-j-1 Cabbage

Includes both European and Chinese cabbage

Pest: External feeders

Treatment: T101-j-1—MB at NAP—tarpaulin or chamber

Temperature (°F)	Dosage Rate (lb/1,000 ft ³)	Minimum Concentration Readings (ounces) At:	
		0.5 hr	2 hrs
70 and above	2.0	26	14
60-69	2.5	32	24
50-59	3.0	38	29
45-49	3.5	43	34
40-44	4.0	48	38

For other *Brassica* spp., use the leafy vegetable schedule, T101-n-2

T101-n-2 Cabbage (*Brassica oleracea*)

Pest: External feeders and leaf miners

Treatment: T101-n-2—MB at NAP—tarpaulin or chamber

Temperature (°F)	Dosage Rate (lb/1,000 ft ³)	Minimum Concentration Readings (ounces) At:	
		0.5 hr	2 hrs
70 and above	2.0	26	14
60-69	2.5	32	24
50-59	3.0	38	29
45-49	3.5	43	34
40-44	4.0	48	38

T101-n-2 Cabbage, Chinese (Bok Choy) (*Brassica chinensis*)

Pest: External feeders and leaf miners

Treatment: T101-n-2—MB at NAP—tarpaulin or chamber

Temperature (°F)	Dosage Rate (lb/1,000 ft ³)	Minimum Concentration Readings (ounces) At:	
		0.5 hr	2 hrs
70 and above	2.0	26	14
60-69	2.5	32	24
50-59	3.0	38	29
45-49	3.5	43	34
40-44	4.0	48	38

NOTICE

Do **not** use this treatment schedule if its FIFRA Section 18 Exemption has expired. For the current exemption status, call your local State Plant Health Director (SPHD).

T101-n-2 Cabbage, Chinese (Napa) (*Brassica pekinensis*)

Pest: External feeders and leaf miners

Treatment: T101-n-2—MB at NAP—tarpaulin or chamber

Temperature (°F)	Dosage Rate (lb/1,000 ft ³)	Minimum Concentration Readings (ounces) At:	
		0.5 hr	2 hrs
70 and above	2.0	26	14
60-69	2.5	32	24
50-59	3.0	38	29
45-49	3.5	43	34
40-44	4.0	48	38

NOTICE

Do **not** use this treatment schedule if its FIFRA Section 18 Exemption has expired. For the current exemption status, call your local State Plant Health Director (SPHD).

T101-n-2 Cabbage, Chinese Mustard (Gai Choy) (*Brassica campestris*)

Pest: External feeders and leaf miners

Treatment: T101-n-2—MB at NAP—tarpaulin or chamber

Temperature (°F)	Dosage Rate (lb/1,000 ft ³)	Minimum Concentration Readings (ounces) At:	
		0.5 hr	2 hrs
70 and above	2.0	26	14
60-69	2.5	32	24
50-59	3.0	38	29
45-49	3.5	43	34
40-44	4.0	48	38

NOTICE

Do **not** use this treatment schedule if its FIFRA Section 18 Exemption has expired. For the current exemption status, call your local State Plant Health Director (SPHD).

T101-k-1 Cantaloupe

Pest: External feeders

Treatment: T101-k-1—MB at NAP—tarpaulin or chamber

Temperature (°F)	Dosage Rate (lb/1,000 ft ³)	Minimum Concentration Readings (ounces) At:	
		0.5 hr	2 hrs
80 and above ¹	1.5	19	14
70-79 ¹	2.0	26	19
60-69	2.5	32	24
50-59	3.0	38	29
40-49	4.0	48	38

¹ Use "MB 100" at 70 °F or above, use MB "Q" label at 40 °F or above

For other melons, see [T101-o-2 Melons \(Including Honeydew, Muskmelon, and Watermelon\)](#).

T101-l-1 Carrot

Pest: External feeders

Treatment: T101-l-1—MB at NAP—tarpaulin or chamber

Temperature (°F)	Dosage Rate (lb/1,000 ft ³)	Minimum Concentration Readings (ounces) At:				
		0.5 hr	2 hrs	3 hrs	3.5 hrs	4 hrs
90 and above	2.0	26	19	19	–	–
80-89	2.5	32	24	24	–	–
70-79	3.0	38	29	24	–	–
60-69	3.0	38	29	–	24	–
50-59	3.0	38	29	–	–	24

T101-m-1 Carrot

Pest: Internal feeders

Treatment: T101-m-1—MB, chamber, 15” vacuum

Temperature (°F)	Dosage Rate (lb/1,000 ft ³)	Exposure Period (hours)
90 and above	2.0	2
80-89	2.5	2
70-79	3.0	2
60-69	3.0	2.5
50-59	3.0	3
40-49	3.0	3.5

NOTICE

As of October 2008, **no** commercial chambers in the United States are approved for the vacuum fumigation of imported commodities. If vacuum treatment is required as a condition of entry, the consignment **must** be destroyed, exported, or returned to country of origin.

T101-n-1 Cassava (Manihot and Yuca)

Pest: External feeders³, Slugs⁴

Treatment: T101-n-1—MB at NAP—tarpaulin or chamber

Temperature (°F)	Dosage Rate (lb/1,000 ft ³)	Minimum Concentration Readings (ounces) At:			
		0.5 hr	2 hrs	3 hrs	3.5 hrs
90 and above	2.0	26	19	19	–
80-89	2.5	32	24	24	–
70-79	3.0	38	29	24	–
60-69	3.0	38	29	–	24

NOTICE

Do **not** use this treatment schedule if its FIFRA Section 18 Exemption has expired. For the current exemption status, call your local State Plant Health Director (SPHD).

³ Use T104-a-1 for hitchhikers.

⁴ Do **not** use T101-n-1 for snails.

T101-n-2 Cauliflower (*Brassica oleracea* var. *botrytis*)

Pest: External feeders and leaf miners

Treatment: T101-n-2—MB at NAP—tarpaulin or chamber

Temperature (°F)	Dosage Rate (lb/1,000 ft ³)	Minimum Concentration Readings (ounces) At:	
		0.5 hr	2 hrs
70 and above	2.0	26	14
60-69	2.5	32	24
50-59	3.0	38	29
45-49	3.5	43	34
40-44	4.0	48	38

NOTICE

Do **not** use this treatment schedule if its FIFRA Section 18 Exemption has expired. For the current exemption status, call your local State Plant Health Director (SPHD).

T101-n-2 Cavalo broccolo (*Brassica oleracea* var. *botrytis*)

Pest: External feeders and leaf miners

Treatment: T101-n-2—MB at NAP—tarpaulin or chamber

Temperature (°F)	Dosage Rate (lb/1,000 ft ³)	Minimum Concentration Readings (ounces) At:	
		0.5 hr	2 hrs
70 and above	2.0	26	14
60-69	2.5	32	24
50-59	3.0	38	29
45-49	3.5	43	34
40-44	4.0	48	38

NOTICE

Do **not** use this treatment schedule if its FIFRA Section 18 Exemption has expired. For the current exemption status, call your local State Plant Health Director (SPHD).

T101-n-1 Celeriac (Celery Root)

Pest: External feeders

Treatment: T101-n-1—MB at NAP—tarpaulin or chamber

Temperature (°F)	Dosage Rate (lb/1,000 ft ³)	Minimum Concentration Readings (ounces) At:			
		0.5 hr	2 hrs	3 hrs	3.5 hrs
90 and above	2.0	26	19	19	–
80-89	2.5	32	24	24	–
70-79	3.0	38	29	24	–
60-69	3.0	38	29	–	24

NOTICE

Do **not** use this treatment schedule if its FIFRA Section 18 Exemption has expired. For the current exemption status, call your local State Plant Health Director (SPHD).

T101-o-1 Celery (Above Ground Parts)

Pest: External feeders

Treatment: T101-o-1—MB at NAP—tarpaulin or chamber

Temperature (°F)	Dosage Rate (lb/1,000 ft ³)	Minimum Concentration Readings (ounces) At:	
		0.5 hr	2 hrs
80 and above	1.5	19	14
70-79	2.0	26	19
60-69	2.5	32	24
50-59	3.0	38	29
40-49	4.0	48	38

For below ground parts, use [T101-n-1 Celeriac \(Celery Root\)](#).**NOTICE**

Do **not** use this treatment schedule if its FIFRA Section 18 Exemption has expired. For the current exemption status, call your local State Plant Health Director (SPHD).

T101-p-1 Chayote (Fruit Only)

Pest: External feeders

Treatment: T101-p-1—MB at NAP—tarpaulin or chamber

Temperature (°F)	Dosage Rate (lb/1,000 ft ³)	Minimum Concentration Readings (ounces) At:	
		0.5 hr	2 hrs
80 and above	1.5	19	14
70-79	2.0	26	19
60-69	2.5	32	24
50-59	3.0	38	29
40-49	4.0	48	38

For below ground parts, use [T101-a-2 Dasheen](#).

NOTICE

Do **not** use this treatment schedule if its FIFRA Section 18 Exemption has expired. For the current exemption status, call your local State Plant Health Director (SPHD).

T101-r-1 Cherry

Pest: Insects other than fruit flies

Treatment: T101-r-1—MB at NAP—tarpaulin or chamber

Temperature (°F)	Dosage Rate (lb/1,000 ft ³)	Minimum Concentration Readings (ounces) At:	
		0.5 hr	2 hrs
80 and above	1.5	19	14
70-79	2.0	26	19
60-69	2.5	32	24
50-59	3.0	38	29
40-49	4.0	48	38

T101-s-1 Cherry

Pest: *Rhagoletis indifferens* (Western cherry fruit fly) and *Cydia pomonella* (codling moth)

Treatment: T101-s-1—MB at NAP—chamber only

Temperature (°F)	Dosage Rate (lb/1,000 ft ³)	Exposure Period (hours)
70 and above	2.0	2
60-69	2.5	2
50-59	3.0	2
40-49	4.0	2

T101-s-1-1 Cherry From Australia

Pest: *Ceratitidis capitata* (Mediterranean fruit fly)

Treatment: T101-s-1-1—MB at NAP—chamber only

Temperature (°F)	Dosage Rate (lb/1,000 ft ³)	Exposure Period (hours)
63 and above	2.5	2

NOTICE

Run the circulation fans continuously during the entire fumigation.

Do **not** exceed a 21 percent (by volume) load factor in the chamber.

T101-t-1 Chestnut (Except Water Chestnut)Pest: *Cydia splendana* (nut fruit tortrix) and *Curculio* spp.

Treatment: T101-t-1—MB at NAP—tarpaulin or chamber

Temperature (°F)	Dosage Rate (lb/1,000 ft ³)	Minimum Concentration Readings (ounces) At:					
		0.5 hr	2 hrs	3 hrs	4 hrs	5 hrs	6 hrs
90 and above	4.0	58	34	34	–	–	–
80-89	4.0	58	32	–	32	–	–
70-79	5.0	72	42	–	42	–	–
60-69	5.0	72	40	–	–	40	–
50-59	6.0	85	50	–	–	50	–
40-49	6.0	85	48	–	–	–	48

T101-u-1 Chestnut (Except Water Chestnut)Pest: *Cydia splendana* (nut fruit tortrix) and *Curculio* spp.

Treatment: T101-u-1—MB in 26" vacuum—chamber

Temperature (°F)	Dosage Rate (lb/1,000 ft ³)	Exposure Period (hours)
80 and above	3.0	2
70-79	4.0	2
60-69	4.0	3
50-59	4.0	4
40-49	4.0	5

T101-v-1 Chicory (Above Ground Parts)

Pest: External feeders

Treatment: T101-v-1—MB at NAP—tarpaulin or chamber

Temperature (°F)	Dosage Rate (lb/1,000 ft ³)	Minimum Concentration Readings (ounces) At:	
		0.5 hr	2 hrs
70 and above	2.0	26	14
60-69	2.5	32	24
50-59	3.0	38	29
45-49	3.5	43	34
40-44	4.0	48	38

For below-ground parts, see [T101-n-1 Chicory Root](#), [T101-z-1 Dasheen \(Eddoe, Malanga, Tannia, Tanya, Taro, and Yautia\)](#), or [T101-a-2 Dasheen](#).

NOTICE

Do **not** use this treatment schedule if its FIFRA Section 18 Exemption has expired. For the current exemption status, call your local State Plant Health Director (SPHD).

T101-n-1 Chicory Root

Pest: External feeders

Treatment: T101-n-1—MB at NAP—tarpaulin or chamber

Temperature (°F)	Dosage Rate (lb/1,000 ft ³)	Minimum Concentration Readings (ounces) At:			
		0.5 hr	2 hrs	3 hrs	3.5 hrs
90 and above	2.0	26	19	19	–
80-89	2.5	32	24	24	–
70-79	3.0	38	29	24	–
60-69	3.0	38	29	–	24

NOTICE

Do **not** use this treatment schedule if its FIFRA Section 18 Exemption has expired. For the current exemption status, call your local State Plant Health Director (SPHD).

T101-w-1 Cipollini (Bulbs)

Pest: *Exosoma lusitanica* (chrysomelid beetle)

Treatment: T101-w-1—MB in 15” vacuum—chamber

Temperature (°F)	Dosage Rate (lb/1,000 ft ³)	Exposure Period (hours)
80 and above	2.0	2
70-79	3.0	2
60-69	4.0	2
50-59	4.0	3
40-49	4.0	4

NOTICE

As of October 2008, **no** commercial chambers in the United States are approved for the vacuum fumigation of imported commodities. If vacuum treatment is required as a condition of entry, the consignment **must** be destroyed, reexported, or returned to country of origin.

T101-w-1-2 Citrus From United States (Interstate Movement)

Pest: *Ceratitis capitata* (Mediterranean fruit fly)

Treatment: T101-w-1-2—MB at NAP—tarpaulin or chamber

See [Ceratitis capitata \(Mediterranean fruit fly\) D301.32-10\(c\)](#) on page 5-8-4.

T101-n-2-1 Grapefruit, Kumquat, Lemon, Lime, Orange, Tangerine/Clementine/Mandarin, Tangelo, and Tango from Chile

Pest: External feeders and *Brevipalpus chilensis* (Chilean false red mite)

Kumquat has been added to T101-n-2-1 through the immediate process described in 7 CFR 305.3(b).

Treatment: T101-n-2-1—MB at NAP—tarpaulin or chamber

Temperature (°F)	Dosage Rate (lb/1,000 ft ³)	Minimum Concentration Readings (ounces) At:	
		0.5 hr	2 hrs
80 and above	1.5	19	14
70-79	2.0	26	19
60-69	2.5	32	24
50-59	3.0	38	29

T101-j-2-1 Clementine (Tangerine), Grapefruit, Orange From Mexico and Quarantine Areas of the U.S.

Pest: *Anastrepha* spp.

Treatment: T101-j-2-1—MB at NAP—chamber

Temperature (°F)	Dosage Rate (lb/1,000 ft ³)	Exposure Period (hours)
80 and above ¹	2.5	2

¹ The temperature was changed from a minimum of 70 °F to 80 °F administratively in October 2005 due to interceptions of live *Anastrepha* larvae.

Load limit **not** to exceed 80 percent of chamber capacity.

Inspect a representative sample of the fruit. If the level of infestation with fruit flies is more than 0.5 percent for the lot, then the fruit is ineligible for fumigation.

T101-n-2 Coles (*Brassica* spp.)*

Pest: External feeders and leaf miners

Treatment: T101-n-2—MB at NAP—tarpaulin or chamber

Temperature (°F)	Dosage Rate (lb/1,000 ft ³)	Minimum Concentration Readings (ounces) At:	
		0.5 hr	2 hrs
70 and above	2.0	26	14
60-69	2.5	32	24
50-59	3.0	38	29
45-49	3.5	43	34
40-44	4.0	48	38

NOTICE

Do **not** use this treatment schedule if its FIFRA Section 18 Exemption has expired. For the current exemption status, call your local State Plant Health Director (SPHD).

NOTICE

*Coles (*Brassica* spp.), EPA Crop Group 5, are restricted to broccoli (*Brassica oleracea* var. *botrytis*); broccoli, Chinese (gai lon) (*Brassica alboglabra*); broccoli raap (rapini) (*Brassica campestris*); Brussels sprouts (*Brassica oleracea* var. *gemmifera*); cabbage (*Brassica oleracea*); Cabbage, Chinese (bok choy) (*Brassica chinensis*); Cabbage, Chinese (napa) (*Brassica pekinensis*); cabbage, Chinese mustard (gai choy) (*Brassica campestris*); cauliflower (*Brassica oleracea* var. *botrytis*); cavalo broccolo (*Brassica oleracea* var. *botrytis*); collards (*Brassica oleracea* var. *acephala*); kale (*Brassica oleracea* var. *acephala*); kohlrabi (*Brassica oleracea* var. *gongyiodes*); mizuna (*Brassica rapa Japonica* group); mustard greens (*Brassica juncea*); mustard spinach (*Brassica rapa Perviridis* group); rape greens (*Brassica napus*)

Of these, cabbage (*Brassica oleracea*) (labeled treatment T101-j-1) is the only vegetable in this group **not** covered by a FIFRA Section 18 Exemption.

T101-n-2 Collard Greens (*Brassica oleracea* var. *acephala*)

Pest: External feeders and leaf miners

Treatment: T101-n-2—MB at NAP—tarpaulin or chamber

Temperature (°F)	Dosage Rate (lb/1,000 ft ³)	Minimum Concentration Readings (ounces) At:	
		0.5 hr	2 hrs
70 and above	2.0	26	14
60-69	2.5	32	24
50-59	3.0	38	29
45-49	3.5	43	34
40-44	4.0	48	38

NOTICE

Do **not** use this treatment schedule if its FIFRA Section 18 Exemption has expired. For the current exemption status, call your local State Plant Health Director (SPHD).

T101-x-1 Copra

(Dried coconuts and whole coconuts without the husk)

Pest: External feeders

Treatment: T101-x-1—MB (“Q” label only) at NAP—tarpaulin or chamber

Temperature (°F)	Dosage Rate (lb/1,000 ft ³)	Minimum Concentration Readings (ounces) At:	
		0.5 hr	2 hrs
80 and above	1.5	19	14
70-79	2.0	26	19
60-69	2.5	32	24

T101-x-1-1 Corn-On-the-Cob (Green corn, Sweet Corn)

Pest: *Ostrinia nubilalis* (European corn borer)

Treatment: T101-x-1-1—MB at NAP—tarpaulin or chamber

Temperature (°F)	Dosage Rate (lb/1,000 ft ³)	Minimum Concentration Readings (ounces) At:	
		0.5 hr	2.5 hrs
70 and above	2.5	32	24

T101-y-1 Cucumber

Pest: External feeders

Treatment: T101-y-1—MB at NAP—tarpaulin or chamber

Temperature (°F)	Dosage Rate (lb/1,000 ft ³)	Minimum Concentration Readings (ounces) At:	
		0.5 hr	2 hrs
80 and above	1.5	19	14
70-79	2.0	26	19
60-69	2.5	32	24
50-59	3.0	38	29

Treatment Schedules T100 - Schedules for Fruits, Nuts, and Vegetables

T101-z-1 Dasheen (Eddoe, Malanga, Tannia, Tanya, Taro, and Yautia)

T101-z-1 Dasheen (Eddoe, Malanga, Tannia, Tanya, Taro, and Yautia)

Pest: External feeders

Treatment: T101-z-1—MB at NAP—tarpaulin or chamber

Temperature (°F)	Dosage Rate (lb/1,000 ft ³)	Minimum Concentration Readings (ounces) At:				
		0.5 hr	2 hrs	3 hrs	3.5 hrs	4 hrs
90 and above	2.0	26	19	19	–	–
80-89	2.5	32	24	24	–	–
70-79	3.0	38	29	24	–	–
60-69	3.0	38	29	–	24	–
50-59	3.0	38	29	–	–	24
40-49	4.0	48	40	–	–	32

NOTICE

Do **not** use this treatment schedule if its FIFRA Section 18 Exemption has expired. For the current exemption status, call your local State Plant Health Director (SPHD).

T101-a-2 Dasheen

Pest: Internal feeders

Treatment: T101-a-2—MB chamber, 15” vacuum—chamber

Temperature (°F)	Dosage Rate (lb/1,000 ft ³)	Exposure Period (hours)
90 and above	2.0	2
80-89	2.5	2
70-79	3.0	2
60-69	3.0	2.5
50-59	3.0	3
40-49	3.0	3.5

NOTICE

Do **not** use this treatment schedule if its FIFRA Section 18 Exemption has expired. For the current exemption status, call your local State Plant Health Director (SPHD).

As of October 2008, **no** commercial chambers in the United States are approved for the vacuum fumigation of imported commodities. If vacuum treatment is required as a condition of entry, the consignment **must** be destroyed, reexported, or returned to country of origin.

T101-b-2 Endive

Pest: External feeders

Treatment: T101-b-2—MB at NAP—tarpaulin or chamber

Temperature (°F)	Dosage Rate (lb/1,000 ft ³)	Minimum Concentration Readings (ounces) At:	
		0.5 hr	2 hrs
70 and above	2.0	26	14
60-69	2.5	32	24
50-59	3.0	38	29
45-49	3.5	43	34
40-44	4.0	48	38

NOTICE

Do **not** use this treatment schedule if its FIFRA Section 18 Exemption has expired. For the current exemption status, call your local State Plant Health Director (SPHD).

T101-c-2 Faba (Fava) Bean (Dried)

Pest: Bruchidae (seed beetles)

Treatment: T101-c-2—MB in 26” vacuum—chamber

Temperature (°F)	Dosage Rate (lb/1,000 ft ³)	Exposure Period (hours)
70 and above	3.0	3.5
60-69	3.0	4
50-59	3.0	4.5
40-49	3.0	5

T101-d-2 Faba (Fava) Bean (Dried)

Pest: Bruchidae (seed beetles)

Treatment: T101-d-2—MB at NAP—tarpaulin or chamber

Temperature (°F)	Dosage Rate (lb/1,000 ft ³)	Minimum Concentration Readings (ounces) At:					
		0.5 hr	2 hrs	11 hrs	12 hrs	13 hrs	14 hrs
70 and above	3.5	46	28	27	–	–	–
60-69	3.5	46	28	–	27	–	–
50-59	3.5	46	28	–	–	27	–
40-49	3.5	46	28	–	–	–	27

If fresh, see [T101-k-2 Green Pod Vegetables](#) or [T101-n-2-1-1 Dried Herbs, Spices, and Mint \(Mentha spp.\) \(All Plant Parts and Seeds\)](#).

T101-e-2 Garlic

Pest: *Brachycerus* spp.(garlic beetles and *Dyspessa ulula* garlic carpenterworm)

Treatment: T101-e-2—MB in 15” vacuum—chamber

Temperature (°F)	Dosage Rate (lb/1,000 ft ³)	Exposure Period (hours)
90 and above	2.0	1.5
80-89	2.0	2
70-79	2.5	2
60-69	3.0	2
50-59	3.0	3
40-49	3.0	4

As of October 2008, **no** commercial chambers in the United States are approved for the vacuum fumigation of imported commodities. If vacuum treatment is required as a condition of entry, the consignment **must** be destroyed, reexported, or returned to country of origin.

Load limit **must not** exceed 80 percent of chamber capacity.

T101-f-2 Ginger (Rhizome)

Pest: Internal feeders

Treatment: T101-f-2—MB chamber, 15” vacuum—chamber

Temperature (°F)	Dosage Rate (lb/1,000 ft ³)	Exposure Period (hours)
90 and above	2.0	3
80-89	2.5	3
70-79	3.0	3
60-69	3.0	3.5

NOTICE

Do **not** use this treatment schedule if its FIFRA Section 18 Exemption has expired. For the current exemption status, call your local State Plant Health Director (SPHD).

NOTICE

As of October 2008, **no** commercial chambers in the United States are approved for the vacuum fumigation of imported commodities. If vacuum treatment is required as a condition of entry, the consignment **must** be destroyed, reexported, or returned to country of origin.

T101-g-2 Ginger (Rhizome)

Pest: External feeders

Treatment: T101-g-2—MB at NAP—tarpaulin or chamber

Temperature (°F)	Dosage Rate (lb/1,000 ft ³)	Minimum Concentration Readings (ounces) At:			
		0.5 hr	2 hrs	3 hrs	3.5 hrs
90 and above	2.0	26	19	19	–
80-89	2.5	32	24	24	–
70-79	3.0	38	29	24	–
60-69	3.0	38	29	–	24

NOTICE

Do **not** use this treatment schedule if its FIFRA Section 18 Exemption has expired. For the current exemption status, call your local State Plant Health Director (SPHD).

T101-h-2 Grape

Pest: *Lobesia botrana* (European grapevine moth)

Treatment T101-h-2—MB at NAP—tarpaulin (4 lbs.) or chamber (3.5 lbs.)
The yellow color of this treatment indicates that the authority to conduct the treatment comes from an emergency action required by PPQ in order to mitigate the pest risk. The emergency action is an interim measure and is pending final regulatory approval.

Temperature (°F)	Dosage Rate (lb./1000 ft ³)	Minimum Concentration Readings (ounces) At:	
		0.5 hr	3 hrs
50 and above	3.5 ¹	50	40
40 and above	4.0 ²	55	45

- 3.5 lb. dosage: **must** be conducted in a chamber with a commodity load **not** to exceed 50 percent.
- 4.0 lb. dosage: **must** be used in conjunction with cold storage (34 °F or lower for a minimum of 10 days). The fumigation may be conducted under tarp.

T101-h-2-1 Grape

Pest: *Ceratitis capitata* (Mediterranean fruit fly)⁵

Treatment: T101-h-2-1—MB at NAP—tarpaulin or chamber

Temperature (°F)	Dosage Rate (lb/1,000 ft ³)	Minimum Concentration Readings (ounces) At:					
		0.5 hr	2 hrs	2.5 hrs	3 hrs	3.5 hrs	4 hrs
70 and above	2.0	26	22	22	–	21	–
65-69	2.0	26	22	22	–	–	19

T101-i-2 Grape

Pest: External feeders and insects other than *Ceratitis capitata* (Mediterranean fruit fly) and mealybugs⁵

Treatment: T101-i-2—MB at NAP—tarpaulin or chamber

Temperature (°F)	Dosage Rate (lb/1,000 ft ³)	Minimum Concentration Readings (ounces) At:	
		0.5 hr	2 hrs
80 and above	1.5	19	14
70-79	2.0	26	19
60-69	2.5	32	24
50-59	3.0	38	29
40-49	4.0	48	38

⁵ Effective November 19, 2010, PPQ suspended the use of T101-h-2-1 and T101-i-2 against *Lobesia botrana*. Use [T101-h-2 Grape](#) if *Lobesia botrana* is detected.

T101-i-2-1 Grape, Baby Kiwi (*Actinidia arguta*), and Pomegranate

Pest: *Brevipalpus chilensis* (Chilean false red mite)

Treatment: T101-i-2-1—MB at NAP—tarpaulin or chamber

Temperature (°F)	Dosage Rate (lb./1000 ft ³)	Minimum Concentration Readings (ounces) At:	
		0.5 hr.	3.0 hrs. ¹
80 and above	1.5	19	14
70-79	2.0	26	19
60-69	2.5	32	24
50-59	3.0	38	29
40-49	4.0	48	38

¹ If the treatment is conducted in a chamber, decrease the total fumigation time to 2.5 hours.

NOTICE

Baby kiwi and pomegranate **must** be treated as FIFRA Section 18 treatments. Do **not** use this treatment schedule if its FIFRA Section 18 Exemption has expired. For the current exemption status, call your local State Plant Health Director (SPHD).

T101-i-2-2 Fig (*Ficus carica*)

Pest: *Brevipalpus chilensis* (Chilean false red mite)

Treatment: T101-i-2-2—MB at NAP—chamber

Temperature (°F)	Dosage Rate (lb./1000 ft ³)	Exposure Period (hours)
70 and above	2.5	3
60-69	3.0	3
50-59	3.5	3

NOTICE

Do **not** use this treatment schedule if its FIFRA Section 18 Exemption has expired. For the current exemption status, call your local State Plant Health Director (SPHD).

T101-j-2 Grapefruit and Other Kinds of Citrus

Pest: *Aleurocanthus woglumi* (citrus blackfly)

Treatment: T101-j-2—MB at NAP—tarpaulin or chamber

Temperature (°F)	Dosage Rate (lb/1,000 ft ³)	Minimum Concentration Readings (ounces) At:	
		0.5 hr	2 hrs
80 and above	1.5	16	12
70-79	1.5	19	15
60-69	1.75	23	17

T101-k-2 Green Pod Vegetables

(Snap, string, yard-long beans, peas, pigeon peas, and lablab beans)

Pest: *Cydia fabivora*, *Crociosema aporema*, *Maruca vitrata* (exotic legume pod borers), *Melanagromyza obtusa* (pigeon pea pod fly), and leaf miners

Treatment: T101-k-2—MB in 15" vacuum—chamber

Temperature (°F)	Dosage Rate (lb/1,000 ft ³)	Exposure Period (hours)
90 and above	0.5	1.5
80-89	1.0	1.5
70-79	1.5	1.5
60-69	2.0	1.5
50-59	2.5	1.5
40-49	3.0	1.5

T101-k-2-1 Green Pod Vegetables

(Snap, string, yard-long beans, peas, pigeon peas, and lablab beans)

Pest: *Cydia fabivora*, *Crocidosema aporema*, *Maruca vitrata* (exotic legume pod borers), *Melanagromyza obtusa* (pigeon pea pod fly), and leaf miners

Treatment: T101-k-2-1—MB at NAP—tarpaulin or chamber

Temperature (°F)	Dosage Rate (lb/1,000 ft ³)	Minimum Concentration Readings (ounces) At:	
		0.5 hr	2 hrs
80 and above	1.5	19	14
70-79	2.0	26	19
60-69	2.5	32	24
50-59	3.0	38	29

The term “green pod vegetables” refers to legumes, **not** peppers or okra.

T101-n-2-1-1 Dried Herbs, Spices, and Mint (*Mentha* spp.)⁶ (All Plant Parts and Seeds)

Pest: Various stored product pests, **not** including khapra beetle⁷

Treatment: T101-n-2-1-1—MB (“Q” label only) at NAP

Temperature (°F)	Dosage Rate (lb/1,000 ft ³)	Minimum Concentration Readings (ounces) At:			
		0.5 hr	4 hrs	16 hrs	24 hrs
70 and above	2.0	24	16	10	–
60-69	2.0	24	16	–	10
50-59	3.0	36	24	15	–
40-49	3.0	36	24	–	15

NOTICE

Dried herbs and spices are restricted to allspice (*Pimenta dioica*); angelica (*Angelica archangelica*); anise (anise seed) (*Pimpinella anisum*); anise star (*Illicium verum*); annato seed; balm (lemon balm) (*Melissa officinalis*); basil (*Ocimum basilicum*); borage (*Borago officinalis*); burnet (*Sanguisorba minor*); chamomile (*Anthemis nobilis*); caper buds (*Capparis spinosa*); caraway (*Carum carvi*); caraway, black (*Nigella sativa*); cardamom (*Elettaria cardamomum*); cassia bark, buds (*Cinnamomum aromaticum*); catnip (*Nepeta cataria*); celery seed (*Apium graveolens*); chervil (dried) (*Anthriscus cerefolium*); chives (*Allium schoenoprasum*); chives, Chinese (*Allium tuberosum*); cinnamon (*Cinnamomum verum*); clary (*Salvia sciarea*); clove buds (*Eugenia caryophyllata*); coriander (cilantro leaf or Chinese parsley seed) (*Coriandrum sativum*); costmary (*Chrysanthemum balsamita*); false coriander (leaf, seed) (*Eryngium foetidum*); cumin (*Cuminum cyminum*); curry (leaf) (*Murraya koenigii*); dill (dillweed seed) (*Anthemum graveolens*); fennel (common) (*Foeniculum vulgare*); fennel, Florence (seed) (*Foeniculum vulgare Azoricum* group); fenugreek (*Trigonella foenumgraecum*); grains of paradise (*Aframomum melgueta*); horehound (*Marrubium vulgare*); hyssop (*Hyssopus officinalis*); juniper berry (*Juniperus communis*); lavender (*Lavendula officinalis*); lemongrass (*Cymbopogon citratus*); lovage (leaf, seed) (*Levisticum officinale*); mace (*Myristica fragrans*); marigold (*Calendula officinalis*); marjoram (*Origanum* spp.) (includes sweet or annual marjoram, wild marjoram, or oregano, and pot marjoram); mustard (seed) (*Brassica juncea*, *B. hirta*, *B. nigra*); nasturtium (*Tropaeolum majus*); nutmeg (*Myristica fragrans*); parsley (dried) (*Petroselinum crispum*); pennyroyal (*Mentha pulegium*); pepper, black (*Piper nigrum*); poppy (seed) (*Papaver somniferum*); rosemary (*Rosmarinus officinalis*); rue (*Ruta graveolens*); saffron (*Crocus sativus*); sage (*Salvia officinalis*); savory (summer and winter) (*Saturega* spp.); sweet bay (bay leaf) (*Laurus nobilis*); tansy (*Tanacetum vulgare*); tarragon (*Artemisia dracunculus*); thyme (*Thymus* spp.); vanilla (*Vanilla planifolia*); wintergreen (*Gaultheria procumbens*); woodruff (*Galium odorata*); wormwood (*Artemisia absinthium*).

⁶ Mint (*Mentha* spp.) **must** be fumigated as a Section 18 Exemption.

⁷ If khapra beetle is intercepted on herbs and spices (dried), do **not** use this schedule. Contact the USDA-APHIS-PPQ-S&T-TMT by phone (305) 278-4877 or email ppqmt@usda.gov.

T101-n-2 Fresh Herbs, Spices, and Mint (*Mentha* spp.) (All Plant Parts Except Seeds)

Pest: External feeders and leaf miners

Treatment: T101-n-2—MB at NAP—tarpaulin or chamber

Temperature	Dosage Rate (lb/1,000 ft ³)	Minimum Concentration Readings (ounces) At:	
		0.5 hr	2 hrs
70 and above	2.0	26	14
60-69	2.5	32	24
50-59	3.0	38	29
45-49	3.5	43	34
40-44	4.0	48	38

NOTICE

Fresh herbs and spices include: allspice (*Pimenta dioica*); angelica (*Angelica archangelica*); anise (anise seed) (*Pimpinella anisum*); anise star (*Illicium verum*); annato seed; balm (lemon balm) (*Melissa officinalis*); basil (*Ocimum basilicum*); borage (*Borago officinalis*); burnet (*Sanguisorba minor*); chamomile (*Anthemis nobilis*); caper buds (*Capparis spinosa*); caraway (*Carum carvi*); caraway, black (*Nigella sativa*); cardamom (*Elettaria cardamomum*); cassia bark, buds (*Cinnamomum aromaticum*); catnip (*Nepeta cataria*); celery seed (*Apium graveolens*); chervil (dried) (*Anthriscus cerefolium*); chives (*Allium schoenoprasum*); chives, Chinese (*Allium tuberosum*); cinnamon (*Cinnamomum verum*); clary (*Salvia sciarea*); clove buds (*Eugenia caryophyllata*); coriander (cilantro leaf or Chinese parsley seed) (*Coriandrum sativum*); costmary (*Chrysanthemum balsamita*); false coriander (leaf, seed) (*Eryngium foetidum*); cumin (*Cuminum cyminum*); curry (leaf) (*Murraya koenigii*); dill (dillweed seed) (*Anthemum graveolens*); fennel (common) (*Foeniculum vulgare*); fennel, Florence (seed) (*Foeniculum vulgare Azoricum* group); fenugreek (*Trigonella foenumgraecum*); grains of paradise (*Aframomum melgueta*); horehound (*Marrubium vulgare*); hyssop (*Hyssopus officinalis*); juniper berry (*Juniperus communis*); kaffir lime leaves (*Citrus hystrix*); lavender (*Lavendula officinalis*); lemongrass (*Cymbopogon citratus*); lovage (leaf, seed) (*Levisticum officinale*); mace (*Myristica fragrans*); marigold (*Calendula officinalis*); marjoram (*Origanum* spp.) (includes sweet or annual marjoram, wild marjoram, or oregano, and pot marjoram); mustard (seed) (*Brassica juncea*, *B. hirta*, *B. nigra*); nasturtium (*Tropaeolum majus*); nutmeg (*Myristica fragrans*); parsley (dried) (*Petroselinum crispum*); pennyroyal (*Mentha pulegium*); pepper, black (*Piper nigrum*); poppy (seed) (*Papaver somniferum*); rosemary (*Rosmarinus officinalis*); rue (*Ruta graveolens*); saffron (*Crocus sativus*); sage (*Salvia officinalis*); savory (summer and winter) (*Saturegia* spp.); sweet bay (bay leaf) (*Laurus nobilis*); tansy (*Tanacetum vulgare*); tarragon (*Artemisia dracunculus*); thyme (*Thymus* spp.); vanilla (*Vanilla planifolia*); wintergreen (*Gaultheria procumbens*); woodruff (*Galium odorata*); wormwood (*Artemisia absinthium*).

NOTICE

Do not use this treatment schedule if its FIFRA Section 18 Exemption has expired. For the current exemption status, call your local State Plant Health Director (SPHD).

T101-I-2 Horseradish

Pest: *Baris lepidii* (imported crucifer weevil)

Treatment: T101-I-2—MB in 15” vacuum—chamber

Temperature (°F)	Dosage Rate (lb/1,000 ft ³)	Exposure Period (hours)
90 and above	2.0	2
80-89	2.5	2
70-79	3.0	2

As of October 2008, **no** commercial chambers in the United States are approved for the vacuum fumigation of imported commodities. If vacuum treatment is required as a condition of entry, the consignment **must** be destroyed, reexported, or returned to country of origin.

T101-n-2 Kale (*Brassica oleracea var. acephala*)

Pest: External feeders and leaf miners

Treatment: T101-n-2—MB at NAP—tarpaulin or chamber

Temperature (°F)	Dosage Rate (lb/1,000 ft ³)	Minimum Concentration Readings (ounces) At:	
		0.5 hr	2 hrs
70 and above	2.0	26	14
60-69	2.5	32	24
50-59	3.0	38	29
45-49	3.5	43	34
40-44	4.0	48	38

NOTICE

Do **not** use this treatment schedule if its FIFRA Section 18 Exemption has expired. For the current exemption status, call your local State Plant Health Director (SPHD).

T101-m-2 Kiwi

Pest: External feeders (**excludes** *Brevipalpus chilensis*), *Nysius huttoni* (wheat bug)

Treatment: T101-m-2—MB at NAP—tarpaulin or chamber

Temperature (°F)	Dosage Rate (lb/1,000 ft ³)	Minimum Concentration Readings (ounces) At:	
		0.5 hr	2 hrs
80 and above	1.5	19	14
70-79	2.0	26	19
60-69	2.5	32	24
50-59	3.0	38	29
40-49	4.0	48	38

NOTICE

Do **not** use this treatment schedule if its FIFRA Section 18 Exemption has expired. For the current exemption status, call your local State Plant Health Director (SPHD).

T101-m-2-1 Kiwi

Pest: *Ceratitis capitata* (Mediterranean fruit fly)

Treatment: T101-m-2-1—MB at NAP—tarpaulin or chamber

Temperature (°F)	Dosage Rate (lb/1,000 ft ³)	Minimum Concentration Readings (ounces) At:			
		0.5 hr	2 hrs	3.5 hrs	4 hrs
70 and above	2.0	26	22	21	–
65-69	2.0	26	22	–	19

NOTICE

Do **not** use this treatment schedule if its FIFRA Section 18 Exemption has expired. For the current exemption status, call your local State Plant Health Director (SPHD).

T101-m-2-2 Kiwi

Pest: *Brevipalpus chilensis* (Chilean false red mite)

Treatment: T101-m-2-2—MB at NAP—tarpaulin or chamber⁸

The yellow color of this treatment indicates that the authority to conduct the treatment comes from an emergency action required by PPQ in order to mitigate the pest risk. The emergency action is an interim measure and is pending final regulatory approval.

NOTICE

Do **not** use this treatment schedule if its FIFRA Section 18 Exemption has expired. For the current exemption status, call your local State Plant Health Director (SPHD).

⁸ If the treatment is conducted in a chamber, decrease the total fumigation time to 2.5 hours.

T101-n-2 Kohlrabi (*Brassica oleracea* var. *gongylodes*)

Pest: External feeders and leaf miners

Treatment: T101-n-2—MB at NAP—tarpaulin or chamber

Temperature (°F)	Dosage Rate (lb/1,000 ft ³)	Minimum Concentration Readings (ounces) At:	
		0.5 hr	2 hrs
70 and above	2.0	26	14
60-69	2.5	32	24
50-59	3.0	38	29
45-49	3.5	43	34
40-44	4.0	48	38

NOTICE

Do **not** use this treatment schedule if its FIFRA Section 18 Exemption has expired. For the current exemption status, call your local State Plant Health Director (SPHD).

T101-n-3 Kumquat (*Fortunella japonica*)

Pest: *Brevipalpus chilensis*, *Ceratitis capitata* (Wiedemann) and *Anastrepha fraterculus* (Wiedmann)

Brevipalpus chilensis has been added to T101-n-3 through the immediate process described in 7 CFR 305.3(b).

Treatment: T101-n-3 MB at NAP—chamber

Temperature (°F)	Dosage Rate (lb/1,000 ft ³)	Exposure Period (hours)
80 and above	3.0	2

T101-n-2 Leafy Vegetables

Pest: External feeders and leaf miners

Treatment: T101-n-2—MB at NAP—tarpaulin or chamber

Temperature (°F)	Dosage Rate (lb/1,000 ft ³)	Minimum Concentration Readings (ounces) At:	
		0.5 hr	2 hrs
70 and above	2.0	26	14
60-69	2.5	32	24
50-59	3.0	38	29
45-49	3.5	43	34
40-44	4.0	48	38

NOTICE

Do **not** use this treatment schedule if its FIFRA Section 18 Exemption has expired. For the current exemption status, call your local State Plant Health Director (SPHD).

NOTICE

Leafy vegetables, (except *Brassica* vegetables) EPA Crop Group 4, are restricted to: Amaranth (leafy amaranth, Chinese spinach, tampala) (*Amaranthus* spp.); Arugula (Roquette) (*Eruca sativa*); Cardoon (*Cyanara cardunculus*); Celery (*Apium graveolens* var. *dulcea*); Celery, Chinese (*Apium graveolens* var. *secalinum*); Celtuce (*Lactuca sativa* var. *angustana*); Chervil (*Anthriscus cerefolium*); Chrysanthemum, edible-leaved (*Chrysanthemum coronarium* var. *coronarium*); Chrysanthemum, garland (*Chrysanthemum coronarium* var. *spatiosum*); Corn salad (*Valerianella locusta*); Cress, garden (*Lepidium sativum*); Cress, upland (yellow rocket, winter cress) (*Babarea vulgaris*); Dandelion (*Taraxacum officinale*); Dock (sorrel) (*Rumex* spp.); Endive (escarole) (*Cichorium endivia*); Fennel, Florence (finocchio) (*Foeniculum vulgare Azoricum* group); Lettuce, head and leaf (*Lactuca sativa*); Orach (*Atriplex hortensis*); Parsley (*Petroselinum crispum*); Purslane, garden (*Portulaca oleracea*); Purslane, winter (*Montia perfoliata*); Radicchio (red chicory) (*Cichorium intybus*); Rhubarb (*Rheum rhabarbarum*); Spinach (*Spinacia oleracea*); Spinach, New Zealand (*Tetragonia tetradonioides*, *T. expansa*); Spinach, vine (Malabar spinach, Indian spinach) (*Basella alba*); Swiss chard (*Beta vulgaris* var. *cicla*). Reference 40CFR 180.41.

T101-q-2 Leeks

Pest: Internal feeders (including leaf miners)

Treatment: T101-q-2—MB at NAP—tarpaulin or chamber

Temperature (°F)	Dosage Rate (lb/1,000 ft ³)	Minimum Concentration Readings (ounces) At:				
		0.5 hr	2 hrs	2.5 hrs	3 hrs	3.5 hrs
90 and above	2.0	26	19	–	–	–
80-89	2.5	32	24	–	–	–
70-79	3.0	38	29	–	–	–
60-69	3.0	38	26	26	–	–
50-59	3.0	38	26	–	26	–
40-49	4.0	38	26	–	–	26

T101-e-1 Lentils (Dry)

Pest: Bruchidae (seed beetles)

Treatment: T101-e-1—MB at NAP—tarpaulin or chamber

Temperature (°F)	Dosage Rate (lb/1,000 ft ³)	Minimum Concentration Readings (ounces) At:					
		0.5 hr	2 hrs	2.5 hrs	3 hrs	3.5 hrs	4 hrs
70 and above	3.0	38	–	24	–	–	–
60-69	3.0	38	29	–	24	–	–
50-59	3.0	38	29	–	–	24	–
40-49	3.0	38	29	–	–	–	24

T101-n-2 Lettuce From Spain

Pest: *Autographa gamma*, *Helicoverpa armigera*, *Mamestra brassicae*, *Spodoptera littoralis*

Treatment: T101-n-2—MB at NAP—tarpaulin or chamber (see [T101-n-2 Leafy Vegetables](#) for treatment schedule)

T101-b-1-1 Lychee (Litchi)

Pest: Mealybugs (Pseudococcidae)

Treatment: T101-b-1-1—MB (“Q” label only) at NAP—tarpaulin or chamber

Temperature (°F)	Dosage Rate (lb/1,000 ft ³)	Minimum Concentration Readings (ounces) At:	
		0.5 hr	2 hrs
80 and above	2.5	32	24
70-79	3.0	38	29
60-69	4.0	48	38

NOTICE

T101-b-1-1 is **not** a substitute for the mandatory cold treatment of lychee from China and Taiwan (T107-h), which targets the pests *Bactrocera dorsalis* (Oriental fruit fly), *Zeugodacus cucurbitae* (melon fly; formerly known as *Bactrocera cucurbitae*), and *Conopomorpha sinensis* (lychee fruit borer). Because mealybugs are **not** controlled by T107-h, T101-b-1-1 can be used as a follow-up treatment if mealybugs are found.

T101-o-2 Melons (Including Honeydew, Muskmelon, and Watermelon)

Pest: External feeders such as Noctuidae, *Thrips* spp., *Copitarsia* spp.

Treatment: T101-o-2—MB at NAP—tarpaulin or chamber

Temperature (°F)	Dosage Rate (lb/1,000 ft ³)	Minimum Concentration Readings (ounces) At:	
		0.5 hr	2 hrs
80 and above ¹	1.5	19	14
70-79 ¹	2.0	26	19
60-69 ¹	2.5	32	24
50-59	3.0	38	29
40-49	4.0	48	38

¹ Use “MB 100” at 60 °F or above, use MB “Q” label at 40 °F or above

For cantaloupe, see, see [T101-k-1 Cantaloupe](#).

T101-n-2 Mizuna (*Brassica rapa Japonica* Group)

Pest: External feeders and leaf miners

Treatment: T101-n-2—MB at NAP—tarpaulin or chamber

Temperature (°F)	Dosage Rate (lb/1,000 ft ³)	Minimum Concentration Readings (ounces) At:	
		0.5 hr	2 hrs
70 and above	2.0	26	14
60-69	2.5	32	24
50-59	3.0	38	29
45-49	3.5	43	34
40-44	4.0	48	38

NOTICE

Do **not** use this treatment schedule if its FIFRA Section 18 Exemption has expired. For the current exemption status, call your local State Plant Health Director (SPHD).

T101-n-2 Mustard Greens (*Brassica juncea*)

Pest: External feeders and leaf miners

Treatment: T101-n-2—MB at NAP—tarpaulin or chamber

Temperature (°F)	Dosage Rate (lb/1,000 ft ³)	Minimum Concentration Readings (ounces) At:	
		0.5 hr	2 hrs
70 and above	2.0	26	14
60-69	2.5	32	24
50-59	3.0	38	29
45-49	3.5	43	34
40-44	4.0	48	38

NOTICE

Do **not** use this treatment schedule if its FIFRA Section 18 Exemption has expired. For the current exemption status, call your local State Plant Health Director (SPHD).

T101-n-2 Mustard Spinach (*Brassica rapa Perviridis* group)

Pest: External feeders and leaf miners

Treatment: T101-n-2—MB at NAP—tarpaulin or chamber

Temperature (°F)	Dosage Rate (lb/1,000 ft ³)	Minimum Concentration Readings (ounces) At:	
		0.5 hr	2 hrs
70 and above	2.0	26	14
60-69	2.5	32	24
50-59	3.0	38	29
45-49	3.5	43	34
40-44	4.0	48	38

NOTICE

Do **not** use this treatment schedule if its FIFRA Section 18 Exemption has expired. For the current exemption status, call your local State Plant Health Director (SPHD).

T101-p-2 Okra*

Pest: *Pectinophora gossypiella* (pink bollworm)

Treatment: T101-p-2—MB at NAP—chamber

Temperature (°F)	Dosage Rate (lb/1,000 ft ³)	Exposure Period (hours)
90 and above	1.0	2
80-89	1.5	2
70-79	2.0	2
60-69	2.5	2
50-59	3.0	2
40-49	3.5	2

*Okra may be injured by fumigation if moisture is present. The term “okra” does **not** include Chinese okra (*Luffa* spp.), which is a cucurbit.

T101-p-2-1 Okra*

Pest: *Pectinophora gossypiella* (pink bollworm)

Treatment: T101-p-2-1—MB at NAP—tarpaulin

Temperature (°F)	Dosage Rate (lb/1,000 ft ³)	Minimum Concentration Readings (ounces) At:	
		0.5 hr	2 hrs
90 and above	1.5	19	14
80-89	2.0	26	19
70-79	2.5	32	24
60-69	3.0	38	29
50-59	3.5	48	38

*Okra may be injured by fumigation if moisture is present or if it is fumigated at temperatures greater than 90 °F. The term “okra” does **not** include Chinese okra (*Luffa* spp.), which is a cucurbit.

T101-q-2 Onion*

Pest: Internal feeders and leaf miners

Treatment: T101-q-2—MB at NAP—tarpaulin or chamber

Temperature (°F)	Dosage Rate (lb/1,000 ft ³)	Minimum Concentration Readings (ounces) At:				
		0.5 hr	2 hrs	2.5 hrs	3 hrs	3.5 hrs
90 and above	2.0	26	19	–	–	–
80-89	2.5	32	24	–	–	–
70-79	3.0	38	29	–	–	–
60-69	3.0	38	26	26	–	–
50-59	3.0	38	26	–	26	–
40-49	3.0	38	26	–	–	26

*The term “onion” includes dry bulbs. It also includes leeks, shallots, and chives for both above-ground and below-ground parts.

T101-g-1 Parsnip

Pest: Internal feeders

Treatment: T101-g-1—MB chamber, 15” vacuum—chamber

Temperature (°F)	Dosage Rate (lb/1,000 ft ³)	Exposure Period (hours)
90 and above	2.0	2
80-89	2.5	2
70-79	3.0	2
60-69	3.0	2.5
50-59	3.0	3
40-49	3.0	3.5

NOTICE

As of October 2008, **no** commercial chambers in the United States are approved for the vacuum fumigation of imported commodities. If vacuum treatment is required as a condition of entry, the consignment **must** be destroyed, exported, or returned to country of origin.

T101-e-1 Peas (Dry)

Pest: Bruchidae (seed beetles)

Treatment: T101-e-1—MB at NAP—tarpaulin or chamber

Temperature (°F)	Dosage Rate (lb/1,000 ft ³)	Minimum Concentration Readings (ounces) At:					
		0.5 hr	2 hrs	2.5 hrs	3 hrs	3.5 hrs	4 hrs
70 and above	3.0	38	–	24	–	–	–
60-69	3.0	38	29	–	24	–	–
50-59	3.0	38	29	–	–	24	–
40-49	3.0	38	29	–	–	–	24

See [T101-k-2 Green Pod Vegetables](#) or [T101-k-2-1 Green Pod Vegetables](#) for fresh peas.

T101-a-3 Peppers

Pest: Internal pests (**except** fruit flies) and external pests (**except** mealybugs)

Treatment: T101-a-3—MB at NAP—tarpaulin or chamber

Temperature (°F)	Dosage Rate (lb/1,000 ft ³)	Minimum Concentration Readings (ounces) At:	
		0.5 hr	2 hrs
80 and above	1.5	19	14
70-79	2.0	26	19
60-69	2.5	32	24
50-59	3.0	38	29
40-49	4.0	48	38

NOTICE

This treatment is **not** effective against fruit flies or mealybugs. For fruit flies, use T106-b (vapor heat). For mealybugs, use T104-a-2 (fumigation). Certain varieties of peppers are sensitive to methyl bromide and may develop darkening of the seed cavity.

T101-r-2 Pineapple

Pest: Internal feeders

Treatment: T101-r-2—MB (“Q” label only) at NAP—tarpaulin or chamber

Temperature (°F)	Dosage Rate (lb/1,000 ft ³)	Minimum Concentration Readings (ounces) At:		
		0.5 hr	2 hrs	6 hrs
70 and above	2.0	26	22	16

T101-s-2 Pineapple

Pest: External feeders

Treatment: T101-s-2—MB (“Q” label if under 70 °F(21.1 °C)) at NAP—tarpaulin or chamber

Temperature (°F)	Dosage Rate (lb/1,000 ft ³)	Minimum Concentration Readings (ounces) At:	
		0.5 hr	2 hrs
80 and above ¹	1.5	19	14
70-79 ¹	2.0	26	19
60-69	2.5	32	24
50-59	3.0	38	29
40-49 ²	4.0	48	38

- 1 Use “MB 100” at 70 °F or above; use MB “Q” label at 40 °F or above.
- 2 40-49 °F temperature range may cause pineapple core to turn purple.

T101-t-2 Plantain

Pest: External feeders such as Noctuidae, *Thrips* spp., *Copitarsia* spp.

Treatment: T101-t-2—MB at NAP—tarpaulin or chamber

Temperature (°F)	Dosage Rate (lb/1,000 ft ³)	Minimum Concentration Readings (ounces) At:	
		0.5 hr	2 hrs
80 and above	1.5	19	14
70-79	2.0	26	19
60-69	2.5	32	24
50-59	3.0	38	29
40-49	4.0	48	38

NOTICE

Do **not** use this treatment schedule if its FIFRA Section 18 Exemption has expired. For the current exemption status, call your local State Plant Health Director (SPHD).

T101-AA—Plum

Pest: *Lobesia botrana* (European grapevine moth)

There are two alternative treatments, T101-AA-1 and -AA-2.

NOTICE

Ensure that the MB manufacturer label allows plum to be fumigated at the required dosage rate and duration.

Fumigate after cold storage (34 °F or lower) for a minimum of 10 days. The cold storage is not subject to verification by PPQ nor CBP and is **not** a quarantine treatment.

T101-AA-1—Plum

Treatment: T101-AA-1—MB at NAP—tarpaulin or chamber

Temperature (°F)	Dosage Rate (lb./1,000 ft ³)	Minimum Concentration Readings (ounces) At:	
		0.5 hr	3 hrs
40 and above	4.0	55	45

T101-AA-2—Plum

Treatment: T101-AA-2—MB at NAP—tarpaulin or chamber

Temperature (°F)	Dosage Rate (lb./1,000 ft ³)	Minimum Concentration Readings (ounces) At:	
		0.5 hr	2 hrs
40 and above	5.0	75	69

T101-u-2 Potato (White or Irish)

Pest: *Graphognathus* spp. (white fringed beetles)

Treatment: T101-u-2—MB at NAP—tarpaulin or chamber

Temperature (°F)	Dosage Rate (lb/1,000 ft ³)	Minimum Concentration Readings (ounces) At:	
		0.5 hr	2 hrs
80 and above	2.5	30	20
70-79	3.0	36	24

T101-v-2 Potato (White or Irish)

Pest: *Ostrinia nubilalis* (European corn borer) and *Phthorimaea operculella* (potato tuberworm)

Treatment: T101-v-2—MB at NAP—tarpaulin or chamber

Temperature (°F)	Dosage Rate (lb/1,000 ft ³)	Minimum Concentration Readings (ounces) At:	
		0.5 hr	2 hrs
70 and above	2.75	33	22

T101-e-1 Pulses, Dried

Pest: Bruchidae (seed beetles)

Treatment: T101-e-1—MB at NAP—tarpaulin or chamber

Temperature (°F)	Dosage Rate (lb/1,000 ft ³)	Minimum Concentration Readings (ounces) At:					
		0.5 hr	2 hrs	2.5 hrs	3 hrs	3.5 hrs	4 hrs
70 and above	3.0	38	–	24	–	–	–
60-69	3.0	38	29	–	24	–	–
50-59	3.0	38	29	–	–	24	–
40-49	3.0	38	29	–	–	–	24

T101-w-2 Pumpkin

Pest: External feeders

Treatment: T101-w-2—MB at NAP—tarpaulin or chamber

Temperature (°F)	Dosage Rate (lb/1,000 ft ³)	Minimum Concentration Readings (ounces) At:	
		0.5 hr	2 hrs
80 and above	1.5	19	14
70-79	2.0	26	19
60-69	2.5	32	24

T101-g-1 Radish

Pest: Internal feeders

Treatment: T101-g-1—MB chamber, 15” vacuum—chamber

Temperature (°F)	Dosage Rate (lb/1,000 ft ³)	Exposure Period (hours)
90 and above	2.0	2
80-89	2.5	2
70-79	3.0	2
60-69	3.0	2.5
50-59	3.0	3
40-49	3.0	3.5

NOTICE

As of October 2008, **no** commercial chambers in the United States are approved for the vacuum fumigation of imported commodities. If vacuum treatment is required as a condition of entry, the consignment **must** be destroyed, reexported, or returned to country of origin.

T101-n-2 Rape Greens (*Brassica napus*)

Pest: External feeders and leaf miners

Treatment: T101-n-2—MB at NAP—tarpaulin or chamber

Temperature (°F)	Dosage Rate (lb/1,000 ft ³)	Minimum Concentration Readings (ounces) At:	
		0.5 hr	2 hrs
70 and above	2.0	26	14
60-69	2.5	32	24
50-59	3.0	38	29
45-49	3.5	43	34
40-44	4.0	48	38

NOTICE

Do **not** use this treatment schedule if its FIFRA Section 18 Exemption has expired. For the current exemption status, call your local State Plant Health Director (SPHD).

T101-x-2 Raspberry

Pest: External feeders such as Noctuidae, *Thrips* spp., *Copitarsia* spp., Pentatomidae

Treatment: T101-x-2—MB at NAP—tarpaulin or chamber

Temperature (°F)	Dosage Rate (lb/1,000 ft ³)	Minimum Concentration Readings (ounces) At:	
		0.5 hr	2 hrs
80 and above	1.5	19	14
70-79	2.0	26	19
60-69	2.5	32	24
50-59	3.0	38	29
40-49	4.0	48	38

NOTICE

Do **not** use this treatment schedule if its FIFRA Section 18 Exemption has expired. For the current exemption status, call your local State Plant Health Director (SPHD).

T101-q-2 Shallots

Pest: Internal feeders (including leaf miners)

Treatment: T1010-q-2—MB at NAP—tarpaulin or chamber

Temperature (°F)	Dosage Rate (lb/1,000 ft ³)	Minimum Concentration Readings (ounces) At:				
		0.5 hr	2 hrs	2.5 hrs	3 hrs	3.5 hrs
90 and above	2.0	26	19	–	–	–
80-89	2.5	32	24	–	–	–
70-79	3.0	38	29	–	–	–
60-69	3.0	38	26	26	–	–
50-59	3.0	38	26	–	26	–
40-49	3.0	38	26	–	–	26

T101-y-2 Squash* (Winter, Summer, and Chayote**)

Pest: External feeders

Treatment: T101-y-2—MB at NAP—tarpaulin or chamber

Temperature (°F)	Dosage Rate (lb/1,000 ft ³)	Minimum Concentration Readings (ounces) At:	
		0.5 hr	2 hrs
80 and above	1.5	19	14
70-79	2.0	26	19
60-69	2.5	32	24
50-59	3.0	38	29
40-49	4.0	48	38

*If zucchini, see [T101-h-3 Zucchini](#). If pumpkin, see [T101-w-2 Pumpkin](#).

** Chayote is **not** covered on any MB label and must be treated as a FIFRA crisis exemption. (see [T101-p-1 Chayote \(Fruit Only\)](#)).

T101-z-2 Strawberry

Pest: External feeders

Treatment: T101-z-2—MB at NAP—tarpaulin or chamber

Temperature (°F)	Dosage Rate (lb/1,000 ft ³)	Minimum Concentration Readings (ounces) At:	
		0.5 hr	2 hrs
80 and above	1.5	19	14
70-79	2.0	26	19
60-69	2.5	32	24
50-59	3.0	38	29

T101-b-3-1 Sweet Potato (*Ipomoea*)

Pest: External and internal feeders

Treatment: T101-b-3-1—MB at NAP—tarpaulin or chamber

Temperature (°F)	Dosage Rate (lb/1,000 ft ³)	Minimum Concentration Readings (ounces) At:		
		0.5 hr	2 hrs	4 hrs
90 and above ¹	2.5	32	20	20
80-89 ¹	3.0	38	24	24
70-79 ¹	3.5	44	28	28
60-69	4.0	50	32	32

¹ Use "MB 100" at 70 °F or above; use MB "Q" label at 60 ° or above.

CAUTION

Temperatures below 70 °F may cause injury to sweet potatoes. Fumigation below 70 °F is to be made only on specific request from the importer.

NOTICE

Sweet potatoes should be cured, free from surface moisture, and held at the fumigation temperature for 24 hours following treatment. This is **not** mandatory; however, following this advice will help maintain the quality of the fumigated product.

T101-c-3 Tomato (from quarantine areas in the United States)

Pest: *Ceratitidis capitata* (Mediterranean fruit fly)

Treatment: T101-c-3—MB at NAP—tarpaulin or chamber

See [Ceratitidis capitata \(Mediterranean fruit fly\) D301.32-10\(c\)](#) on page 5-8-4.

T101-c-3-1 Tomato (From Chile)

Pest: *Phthorimaea absoluta* (tomato leafminer) (formerly *Tuta absoluta* (tomato fruit moth)) and *Rhagoletis tomatis* (tomato fruit fly)

Treatment: T101-c-3-1—MB at NAP—tarpaulin or chamber

Temperature (°F)	Dosage Rate (lb/1,000 ft ³)	Minimum Concentration Readings (ounces) At:	
		0.5 hr	2 hrs
70 and above	3.0	43	33

T101-d-3 Tuna (*Opuntia*) and All Other Fruits From Cacti (Dragon Fruit, Yellow Dragon Fruit, Prickly Pear, Pitaya, Pitahaya)

Pest: *Ceratitis capitata* (Mediterranean fruit fly)

Treatment: T101-d-3—MB at NAP—tarpaulin or chamber

Temperature (°F)	Dosage Rate (lb/1,000 ft ³)	Minimum Concentration Readings (ounces) At:		
		0.5 hr	2 hrs	3.5 hrs
70 and above	2.0	26	21	21

NOTICE

Do **not** use this treatment schedule if its FIFRA Section 18 Exemption has expired. For the current exemption status, call your local State Plant Health Director (SPHD).

T101-e-3 Tuna (*Opuntia*) and All Other Fruits From Cacti (Dragon Fruit, Yellow Dragon Fruit, Prickly Pear, Pitahaya, Pitaya)

Pest: External feeders and leaf miners

Treatment: T101-e-3—MB at NAP—tarpaulin or chamber

Temperature (°F)	Dosage Rate (lb/1,000 ft ³)	Minimum Concentration Readings (ounces) At:	
		0.5 hr	2 hrs
80 and above	1.5	19	14
70-79	2.0	26	19
60-69	2.5	32	24
50-59	3.0	38	29
40-49	4.0	48	38

NOTICE

Do **not** use this treatment schedule if its FIFRA Section 18 Exemption has expired. For the current exemption status, call your local State Plant Health Director (SPHD).

T101-g-1 Turnip

Pest: Internal feeders

Treatment: T101-g-1—MB chamber, 15" vacuum—chamber

Temperature (°F)	Dosage Rate (lb/1,000 ft ³)	Exposure Period (hours)
90 and above	2.0	2
80-89	2.5	2
70-79	3.0	2
60-69	3.0	2.5
50-59	3.0	3
40-49	3.0	3.5

NOTICE

As of October 2008, **no** commercial chambers in the United States are approved for the vacuum fumigation of imported commodities. If vacuum treatment is required as a condition of entry, the consignment **must** be destroyed, reexported, or returned to country of origin.

T101-f-3 Yam (*Dioscorea* spp.)

Pest: Internal and external feeders

Treatment: T101-f-3—MB at NAP—tarpaulin or chamber

Temperature (°F)	Dosage Rate (lb/1,000 ft ³)	Minimum Concentration Readings (ounces) At:		
		0.5 hr	2 hrs	4 hrs
90 and above	2.5	32	20	20
80-89	3.0	38	24	24
70-79	3.5	44	28	28
60-69	4.0	50	32	32

⚠ CAUTION

Temperatures below 70 °F may cause injury to yams. Fumigation below 70 °F is to be made only on specific request from the importer.

NOTICE

Yams should be cured, free from surface moisture, and held at the fumigation temperature for 24 hours following treatment. This is **not** mandatory; however, following this advice will help maintain the quality of the fumigated product.

T101-h-3 Zucchini

Pest: External feeders

Treatment: T101-h-3—MB at NAP—tarpaulin or chamber

Temperature (°F)	Dosage Rate (lb/1,000 ft ³)	Minimum Concentration Readings (ounces) At:	
		0.5 hr	2 hrs
80 and above	1.5	19	14
70-79	2.0	26	19
60-69	2.5	32	24

If another variety of squash, see [T101-y-2 Squash* \(Winter, Summer, and Chayote**\)](#)

T102—Water Treatment

CAUTION

Whenever water comes into contact with fresh produce, the water's quality dictates the potential for pathogen contamination. To reduce the risk of food-borne illnesses, the water used for washing, treatments, and cooling **must** be fortified with sodium hypochlorite (household bleach), and constantly maintained at a chlorine level not to exceed 200 ppm.

T102-b Cherimoya From Chile

Pest: *Brevipalpus chilensis* (Chilean false red mite)

Treatment: T102-b—Soapy water and wax

1. Immerse fruit for 20 seconds in soapy water bath of 1 part soap solution to 3,000 parts water.
2. Follow the soapy bath with a pressure shower rinse to remove all the soapy excess.
3. Immerse fruit for 20 seconds in an undiluted wax coating. The wax coating should cover the entire surface of the fruit.

NOTICE

At the port of entry, the PPQ official should check to make sure the wax coating covers the entire surface of the fruit.

T102-c Durian and Other Large Fruits, such as Breadfruit

Pest: External feeders, scales, and mealybugs (Pseudococcidae)

Treatment: T102-c—Warm, soapy water and brushing

1. Add detergent to warm water (110 ° to 120 °F) at the rate of 1 part detergent or soap to 3,000 parts water.
2. Immerse the fruit for at least 1 minute in the warm detergent water.
3. Using a brush with stiff bristles, have the importer or the importer's agent scrub each fruit to remove any insects.
4. Using a pressure shower, have the importer or the importer's agent rinse the fruit free from residue (detergent and dead insects).
5. Inspect each brushed and cleaned fruit. Pay particular attention to external feeders, mealybugs, and scales. If any insects remain, have the fruit retreated or have it destroyed.

T102-e Limes

Pest: Mealybugs (Pseudococcidae) and other surface pests

Treatment: T102-e—Hot water immersion

1. Treat fruit in a certified hot water immersion treatment tank, and under monitoring of APHIS personnel.
 - A. Submerge fruit at least 4 inches below the water's surface.
 - B. Constantly circulate the water to maintain a temperature of 120.2 °F (or above) for 20 minutes. Treatment time begins when the water temperature reaches at least 120.2 °F in all locations of the tank.
2. Cooling and waxing the fruit are both optional, and are the sole responsibility of the processor.

CAUTION

Phytotoxic damage (increased yellowing) may occur if the temperature reaches 125.6 °F, or if the treatment duration significantly exceeds 20 minutes.

T102-b-1 Limes From Chile

Pest: *Brevipalpus chilensis* (Chilean false red mite)

Treatment: T102-b-1—Soapy water and wax

1. Immerse fruit for 20 seconds in soapy water bath of 1 part soap solution to 3,000 parts water.
2. Follow the soapy bath with a pressure shower rinse to remove all the soapy excess.
3. Immerse fruit for 20 seconds in an undiluted wax coating. The wax coating should cover the entire surface of the fruit.

NOTICE

At the port of entry, the PPQ official should check to make sure the wax coating covers the entire surface of the fruit.

T102-d-1 Longan Fruit From Hawaii

Pest: *Ceratitis capitata* (Mediterranean fruit fly) and *Bactrocera dorsalis* (Oriental fruit fly)

Treatment: T102-d-1—Hot water immersion

NOTICE

Fruit **must** be at ambient temperature before the treatment begins.

1. Submerge fruit at least 4 inches below the water's surface in a hot water immersion tank certified by APHIS.
2. Keep the fruit submerged 20 minutes after the water temperature reaches at least 120.2 °F in all locations of the tank. Constantly circulate the water to maintain a temperature of 120.2 °F (or above) for the duration of the treatment.

CAUTION

Phytotoxic damage (increased yellowing) may occur if the temperature exceeds 121.1 °F.

3. After treatment, cool the fruit to ambient temperature. Hydrocooling for 20 minutes at 75.2 °F is recommended, though **not** required, to prevent injury to the fruit from the hot water immersion treatment.

T102-d Lychee (Litchi) Fruit From Hawaii

NOTICE

Use of Treatment T102-d is at the risk of the shipper. Limited research on fruit quality after treatment application indicated that fruit quality varies among cultivars. 'Kaimana' and 'Kwai Mi' ('Tai So') tolerate the treatment better than 'Brewster' and 'Groff'; no other cultivars were tested.

Pest: *Ceratitis capitata* (Mediterranean fruit fly) and *Bactrocera dorsalis* (Oriental fruit fly)

Treatment: T102-d—Hot water immersion

1. Lychees must be thoroughly examined at the packinghouse by an inspector and found free of *Cryptophlebia* spp. (Lychee fruit moth) and other plant pests.⁹
2. Fruit must be grown and treated in Hawaii, under monitoring of an inspector, in a certified hot water immersion treatment tank.
 - A. Submerge fruit at least 4 inches below the water's surface.
 - B. Constantly circulate the water to maintain a temperature of 120.2 °F (or above) for 20 minutes.
 - C. Treatment does not begin until after the fruit is immersed and the water temperature recovers to 120.2 °F (or above) in all locations throughout the tank. Therefore, before the start of the treatment, fruit pulp temperatures of 70 °F (or above) are recommended to minimize water temperature recovery time and the overall time fruit are immersed in heated water. Fruit quality of treated lychees with initial pulp temperatures below 68 °F has not been studied.

CAUTION

Phytotoxic damage (increased yellowing) may occur if the temperature exceeds 121.1 °F.

3. Hydrocooling for 20 minutes at 75.2 °F is recommended, though **not** required, to prevent injury to the fruit from hot water immersion treatment.

⁹ Because *Eriophyes litchii* (lychee mite) **cannot** be effectively detected by inspection and would **not** be effectively eliminated by hot water immersion, the lychees may **not** be shipped into Florida. Each carton **must** be stamped "**Not** for importation into or distribution in Florida."

T102-a Mango

Pest: *Ceratitis capitata* (Mediterranean fruit fly), *Anastrepha* spp., *Anastrepha ludens* (Mexican fruit fly)

Treatment: T102-a—Hot water immersion

Treat fruit in the country of origin at a certified facility under the monitoring of APHIS personnel.

1. Pre-sort mangoes by weight class. Treatment of mixed loads is **not** allowed.
2. Pulp temperature **must** be 70 °F or above before start of treatment.
3. Submerge fruit at least 4 inches below the water's surface.
4. Constantly circulate the water to maintain a temperature of at least 115 °F throughout the treatment with the following tolerances:
 - ◆ **During the first 5 minutes of a treatment**—Adjusted Tank Temperatures from [Table 6-5-1](#) on page [6-5-3](#) that are below 113.7 °F are allowed during the first 5 minutes of a treatment only if the temperature is at least 115 °F at the end of the 5-minute period.
 - ◆ **For treatments lasting 65 to 75 minutes**—Adjusted Tank Temperatures from [Table 6-5-1](#) on page [6-5-3](#) may fall as low as 113.7 °F for **no** more than 10 minutes under emergency conditions.
 - ◆ **For treatments lasting 90 to 110 minutes**—Adjusted Tank Temperatures from [Table 6-5-1](#) on page [6-5-3](#) may fall as low as 113.7 °F for **no** more than 15 minutes under emergency conditions.
5. Determine the dip time from [Table 5-2-1](#).

NOTICE

Dip times for T102-a are valid if the fruit is **not** hydrocooled within 30 minutes of removal from the hot water immersion tank.

However, if hydrocooling starts immediately after the hot water immersion treatment, then the original dip time **must** be extended for an additional 10 minutes.

Hydrocooling is optional and may be done only at temperatures of 70 °F or above, for any length of time, or **not** at all.

Table 5-2-1 Hot Water Dip Time Based on Weight of Fruit¹

If the weight of the mango (in grams) is:	Then the dip time (in minutes) is:
Up to 375	65
376 to 500	75
501 to 700	90
701 to 900	110

- 1 Valid if the fruit is **not** hydrocooled within 30 minutes of removal from the hot water immersion tank.

T102-b-2 Passion Fruit From Chile

Pest: *Brevipalpus chilensis* (Chilean false red mite)

Treatment: T102-b-2—Soapy water and wax

1. Immerse fruit for 20 seconds in soapy water bath of 1 part soap solution to 3,000 parts water.
2. Follow the soapy bath with a pressure shower rinse to remove all the soapy excess.
3. Immerse fruit for 20 seconds in an undiluted wax coating. The wax coating should cover the entire surface of the fruit.

NOTICE

At the port of entry, the PPQ officer should check to make sure the wax coating covers the entire surface of the fruit.

T103—High Temperature Forced Air

T103-a-1 Citrus From Mexico and Infested Areas in the United States

Pest: *Anastrepha* spp.

Treatment: T103-a-1—High temperature forced air

Heat Up Time:	90 minutes
Heat Up Recording Interval:	2 minutes
Minimum Air Temperature:	N/A
Minimum Pulp Temperature at End of Heat Up:	111.2 °F / 44 °C
Dwell Time:	100 minutes
Dwell Recording Time:	2 minutes
Cooling Method:	Hydrocooling optional

Size Restrictions	Standard Count	Max. Weight/Fruit		Max. Diameter
	Bushel	Grams	Ounces	Inches
Navel orange	100 per 1 2/5	450	15.9	3 13/16
Orange (other than navel)	100 per 1 2/5	468	16.4	3 13/16
Tangerine	120 per 4/5	245	8.6	—
Grapefruit	70 per 1 2/5	536	18.8	4 5/16

T103-b-1 Citrus From Hawaii

Pest: *Ceratitis capitata* (Mediterranean fruit fly), *Bactrocera dorsalis* (Oriental fruit fly), and *Zeugodacus cucurbitae* (melon fly; formerly known as *Bactrocera cucurbitae*)

Treatment: T103-b-1—High temperature forced air

Heat Up Time:	4 hours
Heat Up Recording Interval:	5 minutes
Minimum Air Temperature:	N/A
Minimum Pulp Temperature at End of Heat Up:	117.0 °F / 47.2 °C
Dwell Time:	5 minutes
Dwell Recording Time:	5 minutes
Cooling Method:	Forced air or Hydrocooling

NOTICE

Tolerance of citrus to treatment—Users of this treatment for citrus should test the specific cultivar to determine how well it will tolerate the required heat treatment. Of all citrus species tested to date, grapefruit showed the highest tolerance to this treatment. The tolerance of citrus treated in excess of 7 hours has **not** been determined. Although the method of cooling fruit after treatment is optional, research indicated that forced air cooling using ambient air temperature produced the least fruit injury.

T103-c-1 Mango From Mexico

Pest: *Anastrepha ludens* (Mexican fruit fly), *Anastrepha obliqua* (West Indian fruit fly), and *Anastrepha serpentina* (black fruit fly)

Treatment: T103-c-1—High temperature forced air

Heat Up Time:	N/A
Heat Up Recording Interval:	2 minutes
Minimum Air Temperature:	122.0 °F / 50.0 °C
Minimum Pulp Temperature at End of Heat Up:	118.0 °F / 48.0 °C
Dwell Time:	2 minutes
Dwell Recording Time:	2 minutes
Cooling Method:	Forced air or Hydrocooling
Size Restrictions:	Fruit weight must not exceed 1 1/2 lbs. (700 grams)

T103-d Mountain Papaya From Chile (T103-d-1) and Papaya From Belize and Hawaii (T103-d-2)

Pest: *Ceratitis capitata* (Mediterranean fruit fly), *Bactrocera dorsalis* (Oriental fruit fly), and *Zeugodacus cucurbitae* (melon fly; formerly known as *Bactrocera cucurbitae*)

Treatment: T103-d—High temperature forced air

Heat Up Time:	4 hours
Heat Up Recording Interval:	5 minutes
Minimum Air Temperature:	N/A
Minimum Pulp Temperature at End of Heat Up:	117.0 °F / 47.2 °C
Dwell Time:	5 minutes
Dwell Recording Time:	5 minutes
Cooling Method:	Forced air or Hydrocooling (If papayas are hydrocooled with water lower than 54.5 °F (12.5 °C), the fruit may be damaged.)

NOTICE

Tolerance of papayas to treatment—To enable the papayas to tolerate the treatment, the fruit may first have to be conditioned. Such conditioning is the responsibility of the shipper and at the shipper's risk.

T103-e Rambutan From Hawaii

Pest: *Ceratitis capitata* (Mediterranean fruit fly), and *Bactrocera dorsalis* (Oriental fruit fly)

Treatment: T103-e—High temperature forced air

Heat Up Time:	1 hour
Heat Up Recording Interval:	5 minutes
Minimum Air Temperature:	N/A
Minimum Pulp Temperature at End of Heat Up:	117.0 °F / 47.2 °C
Dwell Time:	20 minutes
Dwell Recording Time:	5 minutes
Cooling Method:	Optional

T104—Pest Specific/Host Variable

For the treatments that follow, **never** exceed the labeled or Section 18 dosage and time for the specific commodity at a given temperature. The specific commodity being treated determines if the schedule is a labeled treatment or one authorized under a Section 18 exemption.

For example, oranges **cannot** be treated for hitchhikers using T104-a-1 at 40-49 °F because this schedule requires 4 lbs. of methyl bromide/1,000 ft³. The methyl bromide “Q” label allows a maximum of **only** 3 lbs. at this temperature range. Therefore, the oranges would have to be heated to at least 50 °F before fumigation because at 50 °F a dosage of only 3 lbs./1,000 ft³ is required.

Although the following treatments are pest specific, the treatment schedule for the associated host will determine if and when a pest specific treatment can be used. Always check the schedule for the host before selecting the proper treatment schedule. Also, consult the methyl bromide label, and do **not** exceed the restrictions on dosage and exposure time.

T104-a-1 Various Commodities

Pest: Hitchhikers and surface pests such as: thrips, aphids, scale insects, leaf miners, spider mites (Tetranychidae)¹⁰, lygaeid bugs, ants, earwigs, surface-feeding caterpillars, and slugs¹¹

Treatment: T104-a-1—MB at NAP—tarpaulin or chamber

Temperature (°F)	Dosage Rate (lb/1,000 ft ³)	Minimum Concentration Readings (ounces) At:	
		0.5 hr.	2 hrs
80 and above	1.5	19	14
70-79	2.0	26	19
60-69	2.5	32	24
50-59	3.0	38	29
40-49	4.0	48	38

To comply with dosage and temperature restrictions on methyl bromide labels, **ONLY** the fruits and vegetables listed may be fumigated with T104-a-1. If you have a commodity that is **not** in the list, it may be listed elsewhere in the T100 schedules for a different pest complex. Refer to [Appendix F](#) (or [40 CFR 180.41 Crop Group Tables](#)) for a list of EPA crop groups and commodities. All commodities included in the EPA sub-groups of each EPA crop group are also eligible for the Section FIFRA Section 18 exemption fumigation.

The **bolded** items in the list are under FIFRA Section 18 Exemption.

NOTICE

Do **not** use T104-a-1 if the FIFRA Section 18 exemption has expired. For any questions concerning the exemption status, call your State Plant Health Director (SPHD) or Regional Treatment Program Manager.

The commodities that are **not bold** are covered on the label. There may be some commodities that are on the label at one dosage and duration, and are also covered in the Section 18 at a different dosage and duration.

EXAMPLE Coffee bean (roasted) is on the Chemtura MB-Q label and can be treated up to 3.0 lbs. for 24 hours. However, the Section 18 allows for coffee bean (unroasted) to be treated up to 9 lbs. for 12 hours.

¹⁰ Do **not** use T104-a-1 for Chilean false red mite (*Brevipalpus chilensis*).

¹¹ Quarantine-significant slugs of the families Agriolimacidae, Arionidae, Limacidae, Milacidae, Philomycidae, and Veronicellidae, including the following genera: *Agriolimax*, *Arion*, *Colosius*, *Deroceras*, *Diplosolenodes*, *Leidyula*, *Limax*, *Meghimatium*, *Milax*, *Pallifera*, *Pseudoveronicella*, *Sarasinula*, *Semperula*, *Vaginulus*, *Veronicella*. **Treat slugs at 60 °F (2.5 lbs.) or above.**

List of Commodities Approved for Fumigation with T104-a-1:

CAUTION

Fumigation may cause damage to some commodities and is at the risk of the importer.

- ◆ 70 °F or above (maximum dosage 2.0 lbs./1,000 ft³): **avocado**, beet (root), blueberry, cocoa bean
- ◆ 60 °F or above (maximum dosage 2.5 lbs./1,000 ft³): **coconut (unprocessed without husk)**, pimento, pumpkin, zucchini squash
- ◆ 50 °F or above (maximum dosage 3.0 lbs./1,000 ft³): clementine, coffee bean (roasted), copra (coconut), corn-on-the-cob (sweet corn), edible podded legumes, grapefruit, kumquat, lemon, lime, mandarin, **Malvaceae seeds for food use, including kenaf and hibiscus, mint (dried)**, okra, onion, orange, parsnip, potato, radish, **root and tuber crop group**¹², rutabaga, salsify root, snow peas, strawberry, sugar beet, tangelo, tangerine, tomato, turnip root
- ◆ 40 °F and above (maximum dosage 4.0 lbs./1,000 ft³): apple, apricot, asparagus, **banana (fruit and leaf)**, beans (fresh), **blueberry**, cabbage, **cactus fruit (tuna)**, cantaloupe, carrot, **chayote**, cherry, chestnut, citron, **coffee bean (unroasted)**, **cottonseed**, cucumber, **cucurbit seed (unprocessed)**, **dasheen**, **dragon fruit**, **edible podded legumes**, eggplant, fava (faba) bean (dried), **fresh figs**, **genip**, grape, herbs (dried), honeydew melon, **ivy gourd**, Jerusalem artichoke, **kaffir lime leaves**, **kola nuts**, **longan**, **loroco flower**, **lychee**, **mango**, **mint (fresh)**, muskmelon, nectarine, **okra**, **opuntia**, peach, pear, peas and beans (dried), pepper, **persimmon**, pineapple, **pitaya/pitahaya**, **plantain**, plum, **pomegranate**, **pointed gourd**, prune, quince, **rambutan**, **snow peas**, squash (summer, winter), **squash flower**, sweet potato, watermelon, yam, **yellow dragon fruit**
- ❖ ANY OTHER UNLABELED COMMODITIES from the following crop groups¹³ are treated under FIFRA exemption: **berry and small fruits**, **Brassica leafy vegetables**, **bulb vegetables**, **cucurbit vegetables**, **fresh herbs and spices**, **fruiting vegetables**, **leafy vegetables**, **leaves of legumes**, **leaves of roots and tubers**, **oilseed**, **stalk/stem/leaf petiole fruit**, **stone fruits including their hybrids**, **tropical and subtropical fruit (edible and inedible peels)**

¹² Use T101-n-1 for external feeders on cassava, celeriac root, and chicory root.

¹³ Crop groups are defined by the Environmental Protection Agency (EPA) in [40CFR 180.41](#) and are provided for quick reference in [Appendix F](#) in this manual.

T104-a-2 Various Commodities

Pest: Mealybugs (Pseudococcidae)

Treatment: T104-a-2—MB at NAP—tarpaulin or chamber

Temperature (°F)	Dosage Rate (lb/1,000 ft ³)	Minimum Concentration Readings (ounces) At:	
		0.5 hr.	2 hrs
80 and above	2.5	32	24
70-79	3.0	38	29
60-69	4.0	48	38

To comply with dosage and temperature restrictions on methyl bromide labels, **ONLY** the fruits and vegetables listed may be fumigated with T104-a-2. If you have a commodity that is **not** listed, it may be elsewhere in the T100 schedules for a different pest complex. Refer to [Appendix F](#) (or [40 CFR 180.41 Crop Group Tables](#)) for a list of EPA crop groups and commodities. All commodities included in the EPA sub-groups of each EPA crop group are also eligible for the Section FIFRA Section 18 exemption fumigation.

The **bolded** items in the list are under FIFRA Section 18 Exemption.

NOTICE

Do **not** use T104-a-2 if the FIFRA Section 18 exemption has expired. For any questions concerning the exemption status, call your State Plant Health Director (SPHD) or Regional Treatment Program Manager.

The commodities that are **not bold** are covered on the label. There may be some commodities that are on the label at one dosage and duration, and are also covered in the Section 18 at a different dosage and duration.

EXAMPLE Coffee bean (roasted) is on the Chemtura MB-Q label and can be treated up to 3.0 lbs. for 24 hours. However, the Section 18 allows for coffee bean (unroasted) to be treated up to 9 lbs. for 12 hours.

List of Commodities Approved for Fumigation with T104-a-2:

CAUTION

Fumigation may cause damage to some commodities and is at the risk of the importer.

- ◆ 80 °F or above (maximum dosage 2.5 lbs./1,000 ft³): **coconut (unprocessed without husk)**, pimento, pumpkin, zucchini squash
- ◆ 70 °F or above (maximum dosage 3.0 lbs./1,000 ft³): **avocado**, bean, carrot, clementine, coffee bean (roasted), copra (coconut), corn-on-the-cob (sweet corn), edible podded legumes, eggplant, grapefruit, kumquat, lemon, lime, mandarin, **Malvaceae seeds for food use including kenaf and hibiscus, dried mint**, okra, onion, orange, parsnip, potato, radish, **root and tuber crop group**, rutabaga, salsify, snow peas, strawberry, sugar beet, tangelo, tangerine, tomato, turnip root
- ◆ 60 °F or above (maximum dosage 4.0 lbs./1,000 ft³): apple, apricot, asparagus, **banana (fruit and leaf), blueberry**, cabbage, **cactus fruit (tuna)**, cantaloupe, carrot, **chayote**, cherry, chestnut, citron (ethrog), **coffee bean (unroasted), cottonseed**, cucumber, **cucurbit seed (unprocessed)**, **dasheen, dragon fruit, edible podded legumes**, fava bean (dried), **fresh figs, genip**, grape, herbs (dried), honeydew melon, **ivy gourd**, Jerusalem artichoke, **kaffir lime leaves, kola nuts, longan, loroco flower, lychee fruit, mango, mint (fresh)**, muskmelon, nectarine, **opuntia, okra**, peach, pear, peas and beans (dried), pepper, **persimmon**, pineapple, **pitaya/pitahaya, plantain**, plum, **pomegranate, pointed gourd**, prune, quince, **rambutan, snow peas**, squash (summer, winter), **squash flower**, sweet potato, watermelon, yam, **yellow dragon fruit**
- ❖ ANY OTHER UNLABELED COMMODITIES from the following crop groups¹⁴ are treated under FIFRA exemption: **berry and small fruits, Brassica leafy vegetables, bulb vegetables, cucurbit vegetables, fresh herbs and spices, fruiting vegetables, leafy vegetables, leaves of legumes, leaves of roots and tubers, oilseed, stalk/stem/leaf petiole fruit, stone fruits including their hybrids, tropical and subtropical fruit (edible and inedible peels)**

¹⁴ Crop groups are defined by the Environmental Protection Agency (EPA) in [40CFR 180.41](#) and are provided for quick reference in [Appendix F](#) in this manual.

T105—Irradiation

Irradiation (IR) is an approved treatment for all imported fruits and vegetables and for fruits and vegetables moved interstate from Hawaii, Puerto Rico, and the U.S. Virgin Islands. In addition, irradiation can be used against particular pests of cut flowers and foliage; however, some damage may occur. Refer to [Table 5-2-2](#) for a list of pest-specific doses.

Treatment **must** be conducted at approved facilities in a foreign country, Hawaii, Puerto Rico, U.S. Virgin Islands, or any area in the U.S. mainland. Refer to 7 CFR 305.9(a)(1) when irradiating in facilities located in AL, AZ, CA, FL, GA, KY, LA, MS, NV, NM, NC, SC, TN, TX, or VA.

Refer to the [Agricultural Commodity Import Requirements \(ACIR\) database Facilities tab](#) for a list of approved United States irradiation facilities.

Refer to chapter [Certifying Irradiation Treatment Facilities](#) on page 6-8-1 of this manual for facility certification requirements.

Commodities that are currently admissible with a treatment or systems approach could also use irradiation as an alternative treatment, provided all the pests targeted by the treatment or systems approach are neutralized by the irradiation dose. Use of irradiation in place of a systems approach or another treatment must be approved and appear in this manual and the [Agricultural Commodity Import Requirements \(ACIR\) database](#) prior to use.

NOTICE

When designing the facility's dosimetry system and procedures for its operation, the facility operator **must** address guidance and principles from American Society for Testing Materials (ASTM) standards or an equivalent standard recognized by the Administrator of APHIS.

The American Society for Testing Materials (ASTM) publication, ISO/ASTM 51261-2002 (E), "*Standard Guide for Selection and Calibration of Dosimetry Systems for Radiation Processing*" is available from:

ASTM
100 Barr Harbor Drive
West Conshohocken, PA
USA
19428-2959

The minimum absorbed doses (MAD) listed in Table 5-2-2 can be applied **only** when all pests of concern can be mitigated. For example, if a country has Mexican fruit fly, West Indian fruit fly, and Sapote fruit fly, the MAD would have to be 100 Gy, not 70 Gy.

Table 5-2-2 Pest-Specific Minimum Absorbed Dose (Gy) For Any Approved Imported Fruits, Vegetables, and Cut Flowers, and Fruits, Vegetables, and Cut Flowers Moved Interstate from Hawaii, Puerto Rico, and the U.S. Virgin Islands

Scientific Name	Common Name	Minimum Absorbed Dose (Gy) Not To Exceed 1,000 Gy	
<i>Rhagoletis pomonella</i>	Apple maggot	60	
<i>Anastrepha ludens</i>	Mexican fruit fly	70	
<i>Anastrepha obliqua</i>	West Indian fruit fly		
<i>Anastrepha suspensa</i>	Caribbean fruit fly		
<i>Conotrachelus nenuphar</i>	Plum curculio		92
<i>Anastrepha serpentina</i>	Sapote fruit fly	100	
<i>Bactrocera jarvisi</i>	Jarvis fruit fly		
<i>Bactrocera tryoni</i>	Queensland fruit fly		
<i>Ceratitis capitata</i>	Mediterranean fruit fly		
<i>Copitarsia decolora</i> (only eggs and larvae)			
<i>Aspidiotus destructor</i>	Coconut scale		150
<i>Zeugodacus cucurbitae</i> (formerly known as <i>Bactrocera cucurbitae</i>)	Melon fruit fly		
<i>Bactrocera dorsalis</i>	Oriental fruit fly		
<i>Cylas formicarius elegantulus</i>	Sweet potato weevil		
<i>Euscepes postfasciatus</i>	West Indian sweet potato weevil		
<i>Omphisa anastomosalis</i>	Sweet potato vine borer		
<i>Pseudaulacaspis pentagona</i>	White peach scale		
	All other fruit flies of the family Tephritidae which are not listed above		
<i>Sternochetus frigidus</i> (Fabr.)	Mango pulp weevil	165	
<i>Cydia pomonella</i>	Codling moth (only eggs and larvae)		
<i>Epiphyas postvittana</i>	Light Brown Apple Moth (only eggs and larvae)	200	
<i>Grapholita molesta</i>	Oriental fruit moth (only eggs and larvae)		
<i>Cryptophlebia ombrodelta</i>	Litchi fruit moth (only eggs and larvae)		250
<i>Cryptophlebia illepidia</i>	Koa seedworm		
	Eggs and larvae of the family Tortricidae not listed	290	
<i>Brevipalpus chilensis</i>	Chilean false red mite	300	
<i>Sternochetus mangiferae</i>	Mango seed weevil		
	Plant pests of the class Insecta not listed above, except pupae and adults of the order Lepidoptera	400	

T105-a-1 Approved Imported Fruits, Vegetables, and Cut Flowers from Specific Countries; Fruits, Vegetables, and Cut Flowers Moved Interstate from Hawaii, Puerto Rico, and the U.S. Virgin Islands

Refer to the website [USDA Plant Health Quarantine Treatments Irradiation Treatment](#) for detailed information regarding the use of irradiation as a quarantine treatment.

Treatment: T105-a 1—IR at 150 Gy

Pest: All fruit flies from the family Tephritidae (Refer to [Table 5-2-2](#) for other pests that can be treated at 150 Gy or less.) Treat using a minimum absorbed dose of 150 Gy, **not** to exceed 1,000 Gy.

NOTICE

Refer to the [Hawaii Manual](#) for detailed inspection procedures and additional entry requirements for pests **not** managed by 150 Gy, or when a 400 Gy dose may be used instead.

[Table 5-2-3](#) lists all currently approved countries and commodities. The irradiation facilities conducting the treatment have been approved and certified by USDA and dose mapping has occurred for each commodity. Countries and commodities can be added (or removed) from this table based on facility certification, compliance agreements, and/or work plans.

Table 5-2-3 Origin and Approved Commodity List for 150 Gy

Origin	Commodity
Colombia	Mango
Ecuador	Avocado (<i>Persea americana</i>), Cape gooseberry (<i>Physalis peruviana</i>)
Grenada	Ambarella (<i>Spondias dulcis</i>), Yellow Mombin (<i>S. mombin</i>), Purple Mombin (<i>S. purpurea</i>)
Hawaii	Abiu, atemoya, banana, breadfruit, <i>Capsicum</i> spp., carambola, citrus, <i>Cucurbita</i> spp., dragon fruit (<i>Selenicereus (Hylocereus)</i> spp.), eggplant, jackfruit, litchi, longan, mangosteen, melon, moringa pods (drumstick), papaya, pineapple, rambutan, sapodilla, sweet potato, tomato, yellow dragon fruit (<i>Selenicereus (Hylocereus) megalanthus</i>)
Jamaica	Mango
Mexico	Carambola, clementine/mandarin/tangerine (<i>Citrus reticulata</i>), dragon fruit (<i>Selenicereus (Hylocereus)</i> spp. also includes the common name pitahaya), fig, grapefruit (<i>C. paradisi</i>), mango, manzano pepper (<i>Capsicum pubescens</i>), pitaya (<i>Stenocereus queretaroensis</i>), pomegranate, sweet lime (<i>C. limetoides</i>), sweet orange (<i>C. sinensis</i>), tangelo (<i>C. tangelo</i>), yellow dragon fruit (<i>Selenicereus (Hylocereus) megalanthus</i>)
Peru	Blueberry, fig, pomegranate
Philippines	Mango
Viet Nam	Pummelo (<i>Citrus maxima</i>)

T105-a-2 Approved Imported Fruits, Vegetables, and Cut Flowers from Specific Countries; Fruits, Vegetables, and Cut Flowers Moved Interstate from Hawaii, Puerto Rico, and the U.S. Virgin Islands

Refer to the website [USDA Plant Health Quarantine Treatments Irradiation Treatment](#) for detailed information regarding the use of irradiation as a quarantine treatment.

Treatment: T105-a-2—IR at 400 Gy

Pest: Fruit flies from the family Tephritidae and all insect pests **except** adults and pupae of the order Lepidoptera

Treat using a minimum absorbed dose of 400 Gy, **not** to exceed 1,000 Gy.

[Table 5-2-4](#) lists all currently approved countries and commodities. The irradiation facilities conducting the treatment have been approved and certified by USDA and dose mapping has occurred for each commodity. Countries and commodities can be added (or removed) from this table based on facility certification, compliance agreements, and/or work plans.

Table 5-2-4 Origin and Approved Commodity List for 400 Gy

Origin	Commodity
Australia	Litchi
Chile	Plum
Dominican Republic	Mango
Ghana	Eggplant, okra, pepper
Hawaii	Banana, breadfruit, cowpea (pod), curry leaf, dragon fruit (<i>Selenicereus (Hylocereus) spp.</i>), guava, jackfruit, mangosteen, melon, moringa pods (drumstick), sweet potato, yellow dragon fruit (<i>Selenicereus (Hylocereus) megalanthus</i>) Cut flowers and leis
India	Mango, pomegranate
Malaysia	Carambola (star fruit), jackfruit, papaya, pineapple, rambutan
Mexico	Fig, Guava
Pakistan	Mango
Philippines	Litchi, longan, rambutan
South Africa	Grape, litchi, persimmon
Taiwan	Guava

Table 5-2-4 Origin and Approved Commodity List for 400 Gy (continued)

Origin	Commodity
Thailand	Dragon fruit (<i>Selenicereus (Hylocereus) spp.</i>), litchi, longan, mango, mangosteen, pineapple, pummelo, rambutan, yellow dragon fruit (<i>Selenicereus (Hylocereus) megalanthus</i>)
Viet Nam	Dragon fruit (<i>Selenicereus (Hylocereus) spp.</i>), litchi, longan, mango, rambutan, star apple, yellow dragon fruit (<i>Selenicereus (Hylocereus) megalanthus</i>)

T105-a-3 Approved Imported Fruits, Vegetables, and Cut Flowers from Specific Countries; Fruits, Vegetables, and Cut Flowers Moved Interstate from Hawaii, Puerto Rico, and the U.S. Virgin Islands

Refer to the website [USDA Plant Health Quarantine Treatments Irradiation Treatment](#) for detailed information regarding the use of irradiation as a quarantine treatment.

Treatment: T105-a-3—IR at 300 Gy

Pest: *Sternochetus mangiferae* (mango seed weevil), and all fruit flies from the family Tephritidae

Treat using a minimum absorbed dose of 300 Gy, **not** to exceed 1,000 Gy.

[Table 5-2-5](#) lists all currently approved countries and commodities. The irradiation facilities conducting the treatment have been approved and certified by USDA and dose mapping has occurred for each commodity. Countries and commodities can be added (or removed) from this table based on facility certification, compliance agreements, and/or work plans.

Table 5-2-5 Origin and Approved Commodity List for 300 Gy

Origin	Commodity
Australia	Mango
Grenada	Mango
Hawaii	Mango
Philippines	Mango

T105-a-4 Mango

Refer to the website [USDA Plant Health Quarantine Treatments Irradiation Treatment](#) for detailed information regarding the use of irradiation as a quarantine treatment.

Treatment: T105-a-4—IR at 165 Gy

Pest: *Sternochetus frigidus* (mango pulp weevil)

Treat using a minimum absorbed dose of 165 Gy, **not** to exceed 1,000 Gy.

[Table 5-2-6](#) lists all currently approved countries and commodities. The irradiation facilities conducting the treatment have been approved and certified by USDA and dose mapping has occurred for each commodity. Countries and commodities can be added (or removed) from this table based on facility certification, compliance agreements, and/or work plans.

Table 5-2-6 Origin and Approved Commodity List for 165Gy

Origin	Commodity
Philippines	Mango

T106—Vapor Heat

T106-a Various Commodities From Mexico: Clementine (T106-a-1), Grapefruit (T106-a-2), Mango (Manila Variety Only; T106-a-3), Orange (T106-a-4)

Pest: *Anastrepha* spp. (includes Mexican fruit fly, *A. ludens*)

Treatment: T106-a—Vapor heat

Heat Up Time:	8 hours
Heat Up Recording Interval:	5 minutes
Minimum Air Temperature:	N/A
Minimum Pulp Temperature at End of Heat Up:	110.0 °F / 43.3 °C
Dwell Time:	6 hours
Dwell Recording Interval:	5 minutes
Cooling Method:	N/A

T106-b Bell Pepper (T106-b-1), Eggplant (T106-b-2), Mountain Papaya (T106-b-3), Papaya (T106-b-4), Pineapple (T106-b-5), Squash (T106-b-6), Tomato (T106-b-7), Zucchini (T106-b-8)

Pest: *Ceratitis capitata* (Mediterranean fruit fly), *Bactrocera dorsalis* (Oriental fruit fly), and *Zeugodacus cucurbitae* (melon fly; formerly known as *Bactrocera cucurbitae*)

Treatment: T106-b—Vapor heat

Heat Up Time:	N/A
Heat Up Recording Interval:	N/A
Minimum Air Temperature:	112.0 °F
Minimum Pulp Temperature at End of Heat Up:	112.0 °F / 44.4 °C
Dwell Time:	8.75 hours
Dwell Recording Interval:	5 minutes
Cooling Method:	Optional

NOTICE

Commodities should be exposed at 112 °F to determine tolerance to the treatment before commercial consignments are attempted.

T106-a-1-1 Clementine or Orange From Mexico

Treatment: T106-a-1-1—Vapor heat

Heat Up Time:	6 hours ¹
Heat Up Recording Interval:	5 minutes
Minimum Air Temperature:	N/A
Minimum Pulp Temperature at End of Heat Up:	110.0 °F / 43.3 °C
Dwell Time:	4 hours
Dwell Recording Interval:	5 minutes
Cooling Method:	N/A

- 1 During the initial raising of fruit temperature, the temperature should be raised rapidly during the first 2 hours; the increase over the next 4 hours should be gradual.

T106-f Litchi and Longan From Hawaii

Pest: *Ceratitis capitata* (Mediterranean fruit fly) and *Bactrocera dorsalis* (Oriental fruit fly)

Treatment: T106-f—Vapor heat

Heat Up Time:	1 hour
Heat Up Recording Interval:	5 minutes
Minimum Air Temperature:	N/A
Minimum Pulp Temperature at End of Heat Up:	117.0 °F / 47.2 °C
Dwell Time:	20 minutes
Dwell Recording Interval:	5 minutes
Cooling Method:	Cool water spray

T106-d-1 Mango From the Philippines (Island of Guimaras Only)

Pest: *Bactrocera occipitalis*, *Zeugodacus cucurbitae* (melon fly; formerly known as *Bactrocera cucurbitae*), and *Bactrocera philippinensis*

NOTICE

Bactrocera philippinensis is part of the *B. dorsalis* species complex.

Treatment: T106-d-1—Vapor heat

Heat Up Time:	4 hours
Heat Up Recording Interval:	5 minutes
Minimum Air Temperature:	N/A
Minimum Pulp Temperature at End of Heat Up:	114.8 °F / 46.0 °C
Dwell Time:	10 minutes
Dwell Recording Interval:	1 minute
Cooling Method:	Hydrocooling optional

T106-d Mango from Taiwan

Pest: *Bactrocera dorsalis* (Oriental fruit fly) and *Zeugodacus cucurbitae* (melon fly; formerly known as *Bactrocera cucurbitae*)

Treatment: T106-d—Vapor heat

Heat Up Time:	N/A
Heat Up Recording Interval:	N/A
Minimum Air Temperature:	N/A
Minimum Pulp Temperature at End of Heat Up:	115.7 °F / 47.5 °C
Dwell Time:	30 minutes
Dwell Recording Interval:	5 minutes
Cooling Method:	Cooling required

T106-c Papaya

Pest: *Ceratitis capitata* (Mediterranean fruit fly), *Bactrocera dorsalis* (Oriental fruit fly), and *Zeugodacus cucurbitae* (melon fly; formerly known as *Bactrocera cucurbitae*)

Treatment: T106-c—Vapor heat

Heat Up Time:	4 hours
Heat Up Recording Interval:	5 minutes
Minimum Air Temperature:	N/A
Minimum Pulp Temperature at End of Heat Up:	117.0 °F / 47.2 °C
Dwell Time:	N/A
Dwell Recording Interval:	N/A
Cooling Method:	Optional

T106-e Yellow Dragon Fruit (*Hylocereus megalanthus*) From Colombia

Pest: *Ceratitis capitata* (Mediterranean fruit fly) and *Anastrepha fraterculus* (South American fruit fly)

Treatment: T106-e—Vapor heat

Heat Up Time:	4 hours
Heat Up Recording Interval:	5 minutes
Minimum Air Temperature:	N/A
Minimum Pulp Temperature at End of Heat Up:	114.8 °F / 46.0 °C
Dwell Time:	20 minutes
Dwell Recording Interval:	5 minutes
Cooling Method:	Hydrocooling optional ¹

- 1 If post-treatment cooling is conducted, wait 30 minutes after the treatment to start the forced cooling process.

T106-g Rambutan From Hawaii

Pest: *Ceratitis capitata* (Mediterranean fruit fly) and *Bactrocera dorsalis* (Oriental fruit fly)

Treatment: T106-g—Vapor heat

Heat Up Time:	1 hour
Heat Up Recording Interval:	5 minutes
Minimum Air Temperature:	N/A
Minimum Pulp Temperature at End of Heat Up:	117.0 °F / 47.2 °C
Dwell Time:	20 minutes
Dwell Recording Interval:	5 minutes
Cooling Method:	Optional

T106-h Sweet Potato From Hawaii

Pest: *Cylas formicarius* (sweet potato weevil), *Euscepes postfasciatus* (West Indian sweet potato weevil), and *Omphisa anastomosalis* (sweet potato vine borer)

Treatment: T106-h—Vapor heat

Heat Up Time:	240 minutes
Heat Up Recording Interval:	N/A
Minimum Air Temperature at Start of Heat Up:	31 °C
Minimum Pulp Temperature at End of Heat Up:	44 °C
Dwell Time:	190 minutes
Dwell Recording Interval:	5 minutes
Minimum Dwell Time Air Temperature:	48 °C
Minimum Dwell Time Pulp Temperature:	47 °C
Cooling Method:	N/A

NOTICE

The relative humidity in the chamber should be 95 percent or greater during the heat up interval (from 31 °C to 44 °C). Relative humidity requirements are for commodity quality. Failure to reach 95 percent relative humidity may decrease the quality of the commodity, but does **not** result in a treatment failure.

T107—Cold Treatment

Pulp of the Fruit

The pulp of the fruit must be at or below the indicated temperature at time of beginning treatment for all cold treatments.

Fruits for Which Cold Treatment is Authorized

The following cold treatment schedules are authorized by Plant Protection and Quarantine (PPQ) for the control of specific pests associated with consignments of fruit. The cold treatment schedule that **must** be used for a specific commodity from a specific country is listed in the [Agricultural Commodity Import Requirements \(ACIR\)](#) database. These cold treatment schedules indicate the specific pests for which they are designed to control.

Treatment upon arrival may be accomplished at authorized ports as named in the permits.

Treatment in-transit may be authorized for specifically equipped and approved vessels or containers, and from approved countries for entry at ports named in the permits. Intransit cold treatment authorization **must** be preceded by a visit to the country of origin by a PPQ Official to explain loading, inspection, and certification procedures to designated certifying officials of the country of origin. Refrigerated compartments on carrying vessels and cold storage warehouses **must** have prior certification by PPQ. Authorization of cold treatments from countries with direct sailing time less than the number of days prescribed for in-transit cold treatment **must** be contingent on the importer understanding that the prescribed in-transit refrigeration period **must** be met before arrival of the vessel at the approved U.S. port.

Gaps in the cold treatment data printout for pulp sensors and air sensors shall be allowed or disallowed on a case-by-case basis, taking into account the number of gaps, the length of each gap, and the temperatures before and after. Air temperatures may occasionally exceed treatment temperatures during defrost cycles; however, fruit temperatures should **not** rise appreciably during this time. During non-defrost times, the temperatures of the air sensors should **never** exceed the maximum allowable treatment temperature.

NOTICE

The fruit **must** be precooled at or below the target treatment temperature prior to loading. A certified USDA representative **must** sample the fruit pulp temperatures during loading in all sections of the lot until precooling has been accomplished.

Treatment Schedules T100 - Schedules for Fruits, Nuts, and Vegetables

T107-a Apple, Apricot, Avocado, Blueberry, Cape Gooseberry, Cherry, Citrus, Ethrog, Grape, Kiwi, Loquat, Litchi (Lychee),

T107-a Apple, Apricot¹⁵, Avocado, Blueberry, Cape Gooseberry, Cherry, Citrus¹⁶, Ethrog, Grape, Kiwi, Loquat, Litchi (Lychee), Nectarine, Orange, Ortanique, Peach, Pear, Persimmon, Plum, Plumcot, Pomegranate, Pummelo, Quince, Sand Pear

Pest: *Ceratitis capitata* (Mediterranean fruit fly) and *Ceratitis rosa* (Natal fruit fly)

Treatment: T107-a—Cold treatment

Temperature	Exposure Period (days)
34 °F (1.11 °C) or below	14
35 °F (1.67 °C) or below	16
36 °F (2.22 °C) or below	18

NOTICE

Pretreatment conditioning for avocado (heat shock or 100.4 °F (38 °C) for 10 to 12 hours) is optional and is the responsibility of the shipper. The pretreatment conditioning, which may improve fruit quality, is described in HortScience 29 (10): 1166-1168. 1994. and 30(5): 1052-1053 (1995).

T107-a-1 Apple, Apricot¹⁷, Blueberry, Cherry, Grape, Grapefruit, Kiwi, Mandarin, Nectarine, Orange, Peach, Pear, Plum, Pomegranate, Quince, Sweet Orange, Tangelo, Tangerine (Includes Clementine)

Pest: *Ceratitis capitata* (Mediterranean fruit fly) and species of *Anastrepha* (other than *Anastrepha ludens*)

Treatment: T107-a-1—Cold treatment

Temperature	Exposure Period (days)
34 °F (1.11 °C) or below	15
35 °F (1.67 °C) or below	17

15 Pluots and plumcots are considered hybrids of plums and apricots and can be treated using T107-a.

16 Citrus includes clementine, grapefruit, lime, lemon, mandarin, orange, satsuma, tangor, tangerine, and other fruits grown from *Citrus reticulata* or its hybrids.

17 Pluots and plumcots are considered hybrids of plums and apricots and can be treated using T107-a-1.

T107-a-2 Orange (*Citrus sinensis*) and Tangor (*Citrus nobilis*) From Australia

Pest: *Ceratitis capitata* (Mediterranean fruit fly)

Treatment: T107-a-2—Cold treatment

Temperature	Exposure Period (days)
37.4 °F (3.0 °C) or below	20

T107-a-3 Lemon (*Citrus limon*) From Australia

Pest: *Ceratitis capitata* (Mediterranean fruit fly)

Treatment: T107-a-3—Cold treatment

Temperature	Exposure Period (days)
35.6 °F (2.0 °C) or below	16
37.4 °F (3.0 °C) or below	18

T107-b Apple, Apricot¹⁸, Cherry, Ethrog, Grapefruit, Litchi, Longan, Orange, Peach, Persimmon, Plum, Pomegranate, Tangerine (includes Clementine), White Zapote

Pest: *Anastrepha ludens* (Mexican fruit fly)

Treatment: T107-b—Cold treatment

Temperature	Exposure Period (days)
33 °F (0.56 °C) or below	18
34 °F (1.11 °C) or below	20
35 °F (1.67 °C) or below	22

18 Pluots and plumcots are considered hybrids of plums and apricots and can be treated using T107-b.

T107-c Apple, Apricot¹⁹, Carambola, Cherry, Grape, Grapefruit, Orange, Pomegranate, Tangerine (Includes Clementine)

Pest: Species of '*Anastrepha* (other than *Anastrepha ludens*)

Treatment: T107-c—Cold treatment

Temperature	Exposure Period (days)
32 °F (0 °C) or below	11
33 °F (0.56 °C) or below	13
34 °F (1.11 °C) or below	15
35 °F (1.67 °C) or below	17

T107-d Apple, Citrus²⁰, Kiwi, Pear

Pest: *Bactrocera tryoni* (Queensland fruit fly)

Treatment: T107-d—Cold treatment

Temperature	Exposure Period (days)
32 °F (0 °C) or below	13
33 °F (0.56 °C) or below	14
34 °F (1.11 °C) or below	18
35 °F (1.67 °C) or below	20
36 °F (2.22 °C) or below	22

T107-d-1 Cherry From Australia

Pest: *Bactrocera tryoni* (Queensland fruit fly)

Treatment: T107-d-1—Cold treatment

Temperature	Exposure Period (days)
33.8 °F (1.0 °C) or below	14
37.4 °F (3.0 °C) or below	15

¹⁹ Pluots and plumcots are considered hybrids of plums and apricots and can be treated using T107-c.

²⁰ Citrus includes clementine, grapefruit, lime, lemon, mandarin, orange, satsuma, tangor, tangerine, and other fruits grown from *Citrus reticulata* or its hybrids.

T107-d-2 Orange (*Citrus sinensis*), Tangerine/Clementine/Mandarin (*C. reticulata*), Tangelo (*C. paradisi* x *C. reticulata*), and

T107-d-2 Orange (*Citrus sinensis*), Tangerine/Clementine/Mandarin (*C. reticulata*), Tangelo (*C. paradisi* x *C. reticulata*), and Tangor (*C. nobilis*) From Australia

Pest: *Bactrocera tryoni* (Queensland fruit fly) and *B. neohumeralis* (lesser Queensland fruit fly)

Treatment: T107-d-2—Cold treatment

Temperature	Exposure Period (days)
32 °F (0 °C) or below	13
33 °F (0.56 °C) or below	14
37.4 °F (3 °C) or below	16

T107-d-3 Lemon (*Citrus limon*) and Grapefruit From Australia

Pest: *Bactrocera tryoni* (Queensland fruit fly) and *B. neohumeralis* (lesser Queensland fruit fly)

Treatment: T107-d-3—Cold treatment

Temperature	Exposure Period (days)
37.4 °F (3.0 °C) or below	14

T107-e Apricot²¹, Citrus, Grape, Nectarine, Peach, Plum

Pest: *Thaumatotibia leucotreta* (false codling moth), *Ceratitis capitata* (Mediterranean fruit fly), *C. quinaria* (five-spotted, Rhodesian, or Zimbabwean fruit fly), *C. rosa* (Natal fruit fly), and *Bactrocera invadens*

NOTICE

Using T107-e to treat *Bactrocera invadens* is approved and is pending regulatory approval. *B. invadens* is part of the *B. dorsalis* species complex.

Treatment: T107-e—Cold treatment

Temperature	Exposure Period (days)
31 °F (-0.55 °C) or below ¹	22

²¹ Pluots and plumcots are considered hybrids of plums and apricots and can be treated using T107-e.

Treatment Schedules T100 - Schedules for Fruits, Nuts, and Vegetables

T107-h Carambola, Litchi (lychee), Longan, Sand Pear

- 1 This treatment shall **not** commence until all sensors are reading 31 °F (-0.55 °C) or below. If the temperature exceeds 31.5 °F (-0.27 °C), the treatment shall be extended one-third of a day for each day or part of a day the temperature is above 31.5 °F (-0.27 °C). If the exposure period is extended, the temperature during the extension period **must** be 34 °F (1.11 °C) or below. If the temperature exceeds 34 °F (1.11 °C) at any time, the treatment is nullified. Also, some freeze damage to the fruit may occur if the pulp temperature is allowed to drop below approximately 29.5 °F (-1.38 °C) (This varies with the commodity.)

T107-h Carambola, Litchi (lychee), Longan, Sand Pear

Pest: *Bactrocera dorsalis* (Oriental fruit fly), *Zeugodacus cucurbitae* (melon fly; formerly known as *Bactrocera cucurbitae*), and *Conopomorpha sinensis* (lychee fruit borer)

Treatment: T107-h—Cold treatment

Temperature	Exposure Period (days)
33.8 °F (1 °C) or below	17
34.5 °F (1.38 °C) or below	20

T107-j Carambola, Litchi (Lychee), Longan, Sand Pear

Pest: *Bactrocera dorsalis* (Oriental fruit fly)

Treatment: T107-j—Cold treatment

Temperature	Exposure Period (days)
33.8 °F (1 °C) or below	15
34.5 °F (1.38 °C) or below	18

NOTICE

Use T107-j when *Bactrocera dorsalis* is the **only** pest of concern that is identified by APHIS PPQ import requirements.

T107-g Pecans and Hickory Nuts

Pest: *Curculio caryae* (pecan weevil)

Treatment: T107-g—Cold treatment

Temperature	Exposure Period (days)
0 °F (-17.78 °C) or below	7

T107-f Ya Pear From China

Treatment: T107-f—Cold treatment

Temperature	Exposure Period (days)
32 °F (0 °C) or below	10
33 °F (0.56 °C) or below	11
34 °F (1.11 °C) or below	12
35 °F (1.67 °C) or below	14

T107-i Barhi Date (*Phoenix dactylifera* L. 'Barhi')Pest: *Ceratitis capitata* (Mediterranean fruit fly)

Treatment: T107-i—Cold treatment

Temperature	Exposure Period (days)
34 °F (1.11 °C) or below	14
35 °F (1.67 °C) or below	16
36 °F (2.22 °C) or below	18

T107-L Orange (*Citrus sinensis*) and Tangerine/Clementine/Mandarin (*C. reticulata*)Pest: *Bactrocera zonata* (Peach fruit fly), *Ceratitis capitata* (Mediterranean fruit fly), *C. rosa* (Natal fruit fly), and *Anastrepha* spp. (other than *A. ludens*)

Treatment: T107-L Cold treatment

Temperature	Exposure Period (days)
35 °F (1.67 °C) or below	18

T107-m Guava (*Psidium guajava*)Pest: *Bactrocera dorsalis* (Oriental fruit fly)

Treatment: T107-m—Cold treatment

Temperature	Exposure Period (days)
32.0 °F (0 °C) or below	12
33.8 °F (1 °C) or below	15

T107-n Guava (*Psidium guajava*)

Pest: *Bactrocera dorsalis* (Oriental fruit fly), *Zeugodacus cucurbitae* (melon fly; formerly known as *B.cucurbitae*), and *Zeugodacus tau* (pumpkin fly; formally known as *B. tau*)

Treatment: T107-n—Cold treatment

Temperature	Exposure Period (days)
33.8 °F (1 °C) or below	17

T107-o Nanfeng Honey Mandarin (*Citrus x aurantium* cv. 'Kinokuni'); Ponkan (*C. x poonensis* hort. ex Tanaka); Sweet Orange (*C. sinensis*); and Unshu/Satsuma Orange (*C. unshiu*) from China

Pest: *Bactrocera correcta*, *B. dorsalis*, *B. occipitalis*, *B. pedestris*, *Zeugodacus tau* (pumpkin fly; formally known as *B. tau*), and *Zeugodacus cucurbitae* (melon fly; formerly known as *B. cucurbitae*)

Treatment: T107-o—Cold treatment

Temperature	Exposure Period (days)
33 °F (0.56 °C) or below	18
34 °F (1.11 °C) or below	20
35 °F (1.67 °C) or below	22

NOTICE

T107-o must be conducted as part of a systems approach. The systems approach guidelines will be detailed in an operational workplan between PPQ and the national plant protection organization of China. The operational workplan includes registered places of production, trapping requirements, grove sanitation, and phytosanitary measures. The efficacy of this treatment as a stand-alone measure has not yet been determined.

T108—Fumigation Plus Cold Treatment of Fruits

The following treatment schedules (fumigation followed by cold treatment) are authorized by Plant Protection and Quarantine (PPQ) for the control of specific pests associated with consignments of fruit. The treatment schedule that must be used for a specific commodity from a specific country is listed in the [Agricultural Commodity Import Requirements \(ACIR\)](#) database. These treatment schedules indicate the specific pests for which they are designed to control.

 **CAUTION**

Some varieties of fruit may be injured by exposure to MB. Importers should be encouraged to treat small samples of fruit to determine tolerance levels before shipping commercial quantities. The USDA is **not** liable for damages caused by quarantine.

T108-a Apple, Apricot²², Avocado, Cherry, Grape, Kiwi, Nectarine, Peach, Pear²³, Plum, Quince

Pest: *Zeugodacus cucurbitae* (melon fly; formerly known as *Bactrocera cucurbitae*), *Bactrocera dorsalis* (Oriental fruit fly), *Bactrocera tryoni* (Queensland fruit fly), *Brevipalpus chilensis* (Chilean false red mite), *Ceratitidis capitata* (Mediterranean fruit fly)

Treatment: T108-a—Fumigation plus cold treatment

NOTICE

For Hawaiian-grown avocados, research has shown that, during the process of cold treatment (T108-a), a single transient heat spike of no greater than 39.6 °F (4.2 °C) and no longer than 2 hours, during or after 6 days of cold treatment, does not affect the efficacy of the treatment. However, in the absence of supporting research, such a tolerance for heat spikes shall not be extended to other fruits.

Pretreatment conditioning for avocado (heat shock or 100.4 °F (38 °C) for 10 to 12 hours) is optional and is the responsibility of the shipper. The pretreatment conditioning, which may improve fruit quality, is described in HortScience 29 (10): 1166-1168. 1994 and 30 (5): 1052-1053 (1995)

CAUTION

Some varieties of fruit may be injured by the 3-hour exposure. Encourage importers to test treat small quantities to determine tolerance before shipping commercial quantities.

NOTICE

Time lapse between fumigation and start of cooling **must not** exceed 24 hours.

²² Plumcot and pluot are considered hybrids of plums and apricots and may also be treated using T108-a provided they are treated under **Section 18 Crisis Exemption**.

²³ Fumigation may cause **severe** damage to Chinese, Japanese, Asian, and sand pears. Obtain the importer's consent before fumigation.

Treatment: T108-a-1²⁴—MB at NAP—Tarpaulin or Chamber Followed by Cold Treatment

Temperature	Dosage Rate (lb/1,000 ft ³)	Minimum Concentration Readings (ounces) At:	
		0.5 hr	2 hrs
70 °F (21.11 °C) or above	2.0	25	18
Followed by cold treatment			

Refrigeration Temperature	Exposure Period (days)
33 to 37 °F (0.56 to 2.77 °C)	4
OR 38 to 47 °F (3.33 to 8.33 °C)	11

Treatment: T108-a-2²⁵—MB at NAP—Tarpaulin or Chamber Followed by Cold Treatment

Temperature	Dosage Rate (lb/1,000 ft ³)	Minimum Concentration Readings (ounces) At:		
		0.5 hr	2 hrs	2.5 hrs
70 °F (21.11 °C) or above	2.0	25	18	18
Followed by cold treatment				

Refrigeration Temperature	Exposure Period (days)
34 to 40°F (1.11 to 4.44 °C)	4
OR 41 to 47 °F (5.0 to 8.33 °C)	6
OR 48 to 56 °F (8.88 to 13.33 °C)	10

Treatment: T108-a-3—MB at NAP—Tarpaulin or Chamber Followed by Cold Treatment

Temperature	Dosage Rate (lb/1,000 ft ³)	Minimum Concentration Readings (ounces) At:			
		0.5 hr	2 hrs	2.5 hrs	3 hrs
70 °F (21.11 °C) or above	2.0	25	18	18	17
Followed by cold treatment					

Refrigeration Temperature	Exposure Period (days)
43 to 47 °F (6.11 to 8.33 °C)	3
OR 48 to 56 °F (8.88 to 13.33 °C)	6

24 Do **not** use T108-a-1 for Chilean false red mite (*Brevipalpus chilensis*). Use T108-a-3.

25 Do **not** use T108-a-2 for Chilean false red mite (*Brevipalpus chilensis*). Use T108-a-3.

T108-b Apple, Grape, and Pear²⁶

Pest: *Austrotortrix* spp. and *Epiphyas* spp. (light brown apple moth complex), *Bactrocera tryoni* (Queensland fruit fly), *Ceratitis capitata* (Mediterranean fruit fly), and other fruit flies.

Treatment: T108-b—MB at NAP—tarpaulin or chamber followed by cold treatment

Temperature	Dosage Rate (lb/1,000 ft ³)	Minimum Concentration Readings (ounces) At:	
		0.5 hr	2 hrs
50 °F (10 °C) or above	1.5	23	20
40-49 °F (4.44 to 9.44 °C)	2.0	30	25
Followed by cold treatment			

Temperature	Exposure Period (days)
33 °F (0.56 °C) or below	21

NOTICE

Load **must not** exceed 80 percent of chamber capacity. Time lapse between fumigation and start of cooling **must not** exceed 24 hours.

²⁶ Fumigation may cause **severe** damage to Chinese, Japanese, Asian, and sand pears. Obtain the importer's consent before fumigation.

T109—Cold Treatment Plus Fumigation of Fruits

T109-d-1 Apple, Grape, and Pear²⁷ From Australia

Pest: *Austrotortrix* spp. and *Epiphyas* spp. (light brown apple moth complex), *Bactrocera tryoni* (Queensland fruit fly), *Ceratitis capitata* (Mediterranean fruit fly), and other fruit flies

Treatment: T109-d-1—Cold treatment followed by MB at NAP—tarpaulin or chamber

Temperature	Exposure Period (days)
33 °F (0.56 °C) or below	21
Followed by MB at NAP—tarpaulin or chamber	

Temperature	Dosage Rate (lb/1,000 ft ³)	Minimum Concentration Readings (ounces) At:	
		0.5 hr	2 hrs
70 °F (21.11 °C) or above	2	30	25
60 to 69 °F (15.55 to 20.55 °C) or above	2.5	36	28
40 to 59 °F (4.44 to 15 °C)	3	44	36

Alternate treatment for *Austrotortrix* and *Epiphyas* is fumigation plus refrigeration (T108-b Apple, Grape, and Pear on page 5-2-100).

Alternate treatment for grapes from Australia as a fruit fly precautionary treatment for *Bactrocera tryoni* and *Ceratitis capitata* is fumigation plus refrigeration (T108-a Apple, Apricot, Avocado, Cherry, Grape, Kiwi, Nectarine, Peach, Pear, Plum, Quince on page 5-2-98, and T108-b Apple, Grape, and Pear on page 5-2-100).

NOTICE

Load **must not** exceed 80 percent of chamber capacity.

²⁷ Fumigation may cause **severe** damage to Chinese, Japanese, Asian, and sand pears. Obtain the importer's consent before fumigation.

T109-a Apple (All Varieties from Japan and 'Fuji' Variety From the Republic of Korea)

Pest: *Carposina niponensis* (peach fruit moth), *Conogethes punctiferalis* (yellow peach moth), *Tetranychus viennensis* (fruit tree spider mite), *Tetranychus kanzawai* (Kanzawa mite)

Two alternative schedules based on type of container:

T109-a-1 Apple (All Varieties from Japan and 'Fuji' Variety From the Republic of Korea)

Apples in plastic field bins at maximum load factor 50 percent or less.

Treatment: T109-a-1—Cold treatment followed by MB at NAP—tarpaulin or chamber

Temperature	Exposure Period (days)
34 °F (1.11 °C) or below	40
Followed by MB at NAP—tarpaulin or chamber	

Temperature	Dosage Rate (lb/1,000 ft ³)	Minimum Concentration Readings (ounces) At:	
		0.5 hr	2 hrs
50 °F (10 °C) or above	3	44	36

T109-a-2 Apple (All Varieties from Japan and 'Fuji' Variety From the Republic of Korea)

Apples in only cardboard cartons at maximum load factor 40 percent or less.

Treatment: T109-a-2—Cold treatment followed by MB at NAP—tarpaulin or chamber

Temperature	Exposure Period (days)
34 °F (1.11 °C) or below	40
Followed by MB at NAP—tarpaulin or chamber, continued on next page	

Treatment Schedules T100 - Schedules for Fruits, Nuts, and Vegetables
T109-a-2 Apple (All Varieties from Japan and 'Fuji' Variety From the Republic of Korea)

Temperature	Dosage Rate (lb/1,000 ft ³)	Minimum Concentration Readings (ounces) At:	
		0.5 hr	2 hrs
59 °F (15 °C) or above	2 lbs 6 oz	35	29

T110—Quick Freeze

Under Development: See [Quick Freeze Guidelines](#) on page 3-7-17 for operational guidelines and equipment specifications.

NOTICE

Never use this treatment for the control of bruchid beetles in dried beans. Research has shown that a treatment of -0.4 °F (-18 °C) for 14 days would be needed to be efficacious.

T110-a

Treatment: T110-a—Quick freeze

1. Initially, lower the commodity's temperature to 0 °F (-17.77 °C) or below.
2. Hold the commodity's temperature at 20 °F (-6.66 °C) or below for at least 48 hours.

The commodity may be transported during the 48-hour treatment period, but at **no** time may the commodity's temperature rise above 20 °F (-6.66 °C) prior to release.

Certain fruits and vegetables are admissible from all foreign countries after receiving this treatment in accordance with 7CFR 319.56-12. Also, interstate movement of all fruits and vegetables from offshore areas of the United States (**except** mango from Hawaii) is authorized in the frozen state after being quick frozen.

T110-b

Treatment: T110-b—Quick freeze for destruction

NOTICE

T110-b may only be used with permission from S&T-TMT. Contact TMT by phone (305) 278-4877 or email ppqmt@usda.gov for official approval.

1. Initially, lower the commodity's temperature to 0 °F (-17.77 °C) or below.
2. Hold the commodity's temperature at 20 °F (-6.66 °C) or below for at least 48 hours.

The commodity may be transported during the 48-hour treatment period, but at **no** time may the commodity's temperature rise above 20 °F (-6.66 °C) prior to release.

3. After treatment, transport the commodity to a landfill for deep burial.

T110-c Miscellaneous Food/Feed Commodities

NOTICE

Historically these treatments have been used on nonfood/nonfeed commodities. Be aware that the treatment may result in severe damage to food or feed commodities.

T110-c schedules may **only** be used with permission from S&T-TMT. Contact TMT by phone (305) 278-4877 or email ppqmt@usda.gov for official approval.

T110-c-1

Pest: Quarantine-significant snails of the families Camaenidae (including the former Bradybaenidae), Geomitridae, Helicidae, Hygromiidae, and Succineidae, including the following genera: *Backeljaia*, *Bradybaena*, *Candidula*, *Cepaea*, *Cathaica*, *Cernuella*, *Cochlicella*, *Helicella*, *Theba*, *Trochoidea*, *Xerolenta*, *Xeropicta*, *Xeroplexa*, *Xerosecta*, *Xerotricha*

Treatment: T110-c-1—Cold treatment

Temperature (°F)	Exposure Period (hours)
0	48

T110-c-2

Pest: Quarantine-significant snails of the family Helicidae, including the following genera: *Helix*, *Otala*

Treatment: T110-c-2 —Cold treatment

Temperature (°F)	Exposure Period (hours)
0	32
10	48

T110-c-3

Pest: Quarantine-significant snails of the family Achatinidae, including the following genera: *Achatina*, *Archachatina*, *Lignus*, *Limicolaria*, *Lissachatina*

NOTICE

Do **not** use this treatment against snails in the subfamily Subulininae.

Treatment: T110-c-3—Cold treatment

Temperature (°F)	Exposure Period (hours)
0	8
10	16
20	24

Treatment Schedules

T200 - Schedules for Propagative Plant Material

Contents

NOTICE

Plant and plants parts treated under the T200 series schedules are **not** to be used for food or feed purposes.

T201—Plants **5-3-2**

T202—Bulbs, Corms, Tubers, Rhizomes, and Roots **5-3-22**

T203—Seeds **5-3-30**

The condition of the plants at the time of treatment may have a bearing on reaction to treatment.

Report any new or unusual observances relating to treatment tolerance of treated material to the USDA-APHIS-PPQ-S&T-TMT, giving details of the treatment and the conditions of application. In appraising the effects of a particular treatment, take care to distinguish between the actual or apparent effects attributable to the treatment and those **not** related to the treatment.

NOTICE

Containers. Give boxes, crates, and other propagative containers the same treatment as the propagative material with which they are associated. **Exceptions** are necessary, however, when significant pests are found infesting containers or packing materials that would **not** be controlled by the treatment required for the contents.

T201—Plants

CAUTION

Plant Tolerance. In general, nursery stock should be fumigated in a normal atmospheric pressure (NAP) chamber. Damage may occur when treatment is performed under a tarpaulin. When selecting a treatment for a particular pest, consider the tolerance of the plant material to the treatment. Refer to the “Handbook of Plant Tolerances to Quarantine Treatments” to determine if a genus or species is tolerant to treatment.

T201-q Aquatic Plants Infested with Freshwater Snails

Pest: Snails of the following families: Ampulariidae, Lymnaeidae, Planorbidae, Viviparidae

Treatment: T201-q—Hot water treatment 112 °F for 10 minutes. *Egeria densa* and *Cabomba caroliniana* plants are **not** tolerant to this treatment. Inspection stations should refer to their reference report guide for host tolerances to the hot water treatment.

T201-e-1 Bromeliads

Pest: External feeders

Treatment: T201-e-1 MB (“Q” label only) at NAP—tarpaulin or chamber

Temperature (°F)	Dosage Rate (lb/1,000 ft ³)	Exposure Period (hours)
90-96	2.0	1.5
80-89	2.0	2
70-79	3.0	2
60-69	3.0	2.5
50-59	3.0	3

T201-e-2 Bromeliads

Pest: Internal feeders, such as borers and miners

Treatment: T201-e-2 MB (“Q” label only) at 15” vacuum

Temperature (°F)	Dosage Rate (lb/1,000 ft ³)	Exposure Period (hours)
90-96	2.0	1.5
80-89	2.0	2
70-79	3.0	2
60-69	3.0	2.5
50-59	3.0	3

T201-f-1 Cacti and Other Succulents

Pest: External feeders (other than soft scales) infesting collected dormant and nondormant plant material

Treatment: T201-f-1 MB (“Q” label only) at NAP—tarpaulin or chamber

Temperature (°F)	Dosage Rate (lb/1,000 ft ³)	Exposure Period: (hours)	
		<i>Otiorhynchus</i> (formerly <i>Brachyrhinus</i>) larvae	All others
90-96	2.0	2.5	2
80-89	2.5	2.5	2
70-79	3.0	2.5	2
60-69	3.0	3	2.5
50-59	3.0	3.5	3
40-49	3.0	4	3.5

T201-f-2 Cacti and Other Succulents

Pest: Borers and soft scales

Treatment: T201-f-2 MB (“Q” label only) in 15” vacuum

Temperature (°F)	Dosage Rate (lb/1,000 ft ³)	Exposure Period: (hours)	
		<i>Otiorhynchus</i> (formerly <i>Brachyrhinus</i>) larvae	All others
90-96	2.0	2.5	2
80-89	2.5	2.5	2
70-79	3.0	2.5	2
60-69	3.0	3	2.5
50-59	3.0	3.5	3
40-49	3.0	4	3.5

NOTICE

Vacuum fumigation requires prior consent of the importer. If consent is denied, REFUSE ENTRY unless hand removal plus 100 percent inspection is feasible.

Bromeliads, see [T201-e-3-1 Pineapple Slips](#) on page 5-3-16

Kalanchoe synsepala, see [T201-p Plant Material Not Tolerant to Fumigation](#) on page 5-3-20

Sedum adolphi, see [T201-p Plant Material Not Tolerant to Fumigation](#) on page 5-3-20

T201-g-1 *Chrysanthemum* spp., Rooted and Unrooted Cuttings

CAUTION

Obtain consent of the importer prior to fumigation since some damage may occur.

Pest: Aphids

Treatment: T201-g-1 MB (“Q” label only) at NAP—tarpaulin or chamber

Temperature (°F)	Dosage Rate (lb/1,000 ft ³)	Exposure Period (hours)
70 and above	0.75	2

T201-g-2 *Chrysanthemum* spp., Rooted and Unrooted Cuttings

DO NOT USE this treatment schedule.
The schedule is not authorized for use and will be removed or revised following a Federal Register notice according to 7 CFR 305.3.

May 01, 2012

Pest: External feeders

Treatment: T201-g-2 Malathion-carbaryl chemical dip—Hand removal of pests of infested parts *plus* a malathion-carbaryl chemical dip. Solution prepared by adding 3 level tablespoons of 25 percent malathion wettable powder and 3 level tablespoons of 50 percent carbaryl wettable powder to each gallon of water. The addition of a sticker-spreader formulation may be required

for hard to wet plants. Use fresh chemicals and prepare dip for the same day use. Plants, including the roots, should be entirely submerged in the chemical dip for 30 seconds.

T201-g-3 *Chrysanthemum* spp., Rooted and Unrooted Cuttings*

Pest: Leaf miners, aphids, mites, etc.

Treatment: T201-g-3—Hot water at 110-111 °F for 20 minutes

*This treatment is marginal as to host tolerance.

NOTICE

Chrysanthemum spp. from the Dominican Republic and Colombia, when infested with Agromyzid leaf miners, requires **no** treatment unless destined to Florida.

T201-l Commodities Infested with Quarantine-Significant Slugs

Pest: Quarantine significant slugs of the families Agriolimacidae, Arionidae, Limacidae, Milacidae, Philomycidae, and Veronicellidae, including the following genera:

Agriolimax, Arion, Colosius, Deroceras, Diplosolenodes, Leidyula, Limax, Meghimatium, Milax, Pallifera, Pseudoveronicella, Sarasinula, Semperula, Vaginulus, Veronicella

Treatment: T201-l MB (“Q” label only) at NAP—tarpaulin or chamber

Temperature (°F)	Dosage Rate (lb/1,000 ft ³)	Minimum Concentration Readings (ounces) At:	
		0.5 hour	2 hrs
90-96	1.0	12	9
80-89	1.25	15	12
70-79	1.5	18	15
60-69	1.75	22	19

T201-h-1 Cycads—Excluding *Dioon edule* (Chestnut Dioon)

Pest: External feeders

Treatment: T201-h-1 MB (“Q” label only) in 15” vacuum

Temperature (°F)	Dosage Rate (lb/1,000 ft ³)	Exposure Period (hours)
90-96	2.0	2
80-89	2.5	2
60-79	3.0	2
40-59	3.0	2.5

T201-a-1 Deciduous Woody Plants (Dormant)

Pest: External feeders

Treatment: T201-a-1 MB (“Q” label only) at NAP

Temperature (°F)	Dosage Rate (lb/1,000 ft ³)	Exposure Period (hours)	
		<i>Otiorhynchus</i> (formerly <i>Brachyrhinus</i>) larvae	All Others
90-96	2.0	2.5	2
80-89	2.5	2.5	2
70-79	3.0	2.5	2
60-69	3.0	3	2.5
50-59	3.0	3.5	3
40-49	3.0	4	3.5

For gypsy moth egg masses, use [T313-a Cut conifer Christmas trees](#) on page 5-4-44 or [T313-b Cut pine Christmas trees and pine logs](#) on page 5-4-44.

NOTICE

If treating for mealybugs, use [T305-c Cut flowers and greenery](#) on page 5-4-21.

NOTICE

This schedule is **not** entirely satisfactory for use against egg masses of *Yponomeuta malinellus* (apple ermine moth).

T201-a-2 Deciduous Woody Plants (Dormant)

Root cuttings, scion wood cuttings, and nonfoliated citrus whitefly host, such as *Acer*, *Berberis*, *Fraxinus*, *Philadelphus*, *Rosa*, *Spiraea*, and *Syringa*

Pest: Borers

Treatment: T201-a-2 MB (“Q” label only) in 26” vacuum

Temperature (°F)	Dosage Rate (lb/1,000 ft ³)	Exposure Period (hours)	
		<i>Otiorhynchus</i> (formerly <i>Brachyrhinus</i>) larvae	All Others
90-96	2.0	2.5	2
80-89	2.5	2.5	2
70-79	3.0	2.5	2
60-69	3.0	3	2.5
50-59	3.0	3.5	3
40-49	3.0	4	3.5

NOTICE

Citrus whitefly hosts, see [T201-k-1 Foliated Host Plants of *Dialeurodes citri* \(Citrus Whitefly\)](#), [Excluding *Osmanthus americanus* on page 5-3-10](#), and [T201-b-1 Evergreens \(Broadleaved and Coniferous Genera\) on page 5-3-9](#).

T201-h-2 *Dioon edule* (Chestnut Dioon)

For other cycads, see [T201-h-1 Cycads—Excluding *Dioon edule* \(Chestnut Dioon\)](#) on page 5-3-6.

Pest: External feeders

Treatment: T201-h-2 MB (“Q” label only) in 26” vacuum

Temperature (°F)	Dosage Rate (lb/1,000 ft ³)	Exposure Period (hours)
90-96	2.0	2
80-89	2.5	2
60-79	3.0	2
40-59	3.0	2.5

T201-i-1 *Dieffenbachia* spp., *Dracaena* spp., *Philodendron* spp. (Plants and Cuttings)

Pest: External feeders

Treatment: T201-i-1 MB (“Q” label only) at NAP—tarpaulin or chamber

Temperature (°F)	Dosage rate (lb/1,000 ft ³)	Minimum Concentration Readings (ounces) At:				
		0.5 hr	1.5 hrs	2 hrs	2.5 hrs	3 hrs
90-96	2.0	24	16	–	–	–
80-89	2.0	24	–	16	–	–
70-79	3.0	36	–	24	–	–
60-69	3.0	36	–	–	24	–
50-59	3.0	36	–	–	–	24

NOTICE

This treatment may cause leaf tip burn in *Dieffenbachia* (dumbcane).

T201-i-2 *Dieffenbachia* spp., *Dracaena* spp., *Philodendron* spp. (Plants and Cuttings)

Pest: Internal feeders

Treatment: T201-i-2 MB (“Q” label only) in 26” vacuum

Temperature (°F)	Dosage Rate (lb/1,000 ft ³)	Exposure Period (hours)
90-96	2.0	1.5
80-89	2.0	2
70-79	3.0	2
60-69	3.0	2.5
50-59	3.0	3

Immature and tender plants and cuttings, and species and varieties known or considered to be affected by MB, should **not** be fumigated **without** consent of the importer. **Without** such consent, REFUSE entry.

NOTICE

This schedule may cause leaf tip burn in *Dieffenbachia* (dumbcane).

T201-b-1 Evergreens (Broadleaved and Coniferous Genera)

Coniferous genera, such as *Cedrus*, *Cupressus*, *Juniperus*, *Podocarpus*, *Thuja*, and *Taxus*. Broadleaved genera such as *Azalea*, *Berberis*, *Camellia*, *Ilex*, and *Photinia*.

Pest: External feeders

Treatment: T201-b-1 MB (“Q” label only) at NAP—tarpaulin or chamber

Temperature (°F)	Dosage Rate (lb/1,000 ft ³):		Exposure Period (hours)	
	<i>Otiorhynchus</i> (formerly <i>Brachyrhinus</i>) larvae	All others	<i>Otiorhynchus</i> (formerly <i>Brachyrhinus</i>) larvae	All others
90-96	2.0	1.5	2.5	2
80-89	2.5	2	2.5	2
70-79	3.0	2.5	2.5	2
60-69	3.0	2.5	3	2.5
50-59	3.0	2.5	3.5	3
40-49	3.0	2.5	4	3.5

NOTICE

If treating for mealybugs, fumigate at 60 °F or above.

Exceptions:

Araucaria spp., see [T201-c-1 Greenhouse-Grown Plants, Herbaceous Plants and Cuttings, and Greenwood Cuttings of Woody Plants](#)

Azalea indica, see [T201-c-2 Greenhouse-Grown Plants, Herbaceous Plants and Cuttings, and Greenwood Cuttings of Woody Plants](#)

Cycads, see [T201-l Commodities Infested with Quarantine-Significant Slugs](#)

Citrus whitefly hosts, see [T201-k-1 Foliated Host Plants of *Dialeurodes citri* \(Citrus Whitefly\), Excluding *Osmanthus americanus*](#)

Daphne spp., see [T201-c-1 Greenhouse-Grown Plants, Herbaceous Plants and Cuttings, and Greenwood Cuttings of Woody Plants](#)

Lavandula spp., see [T201-p-1 Plant Material Not Tolerant to Fumigation](#)

Osmanthus americanus, see [T201-p-2 Plant Material Not Tolerant to Fumigation](#)

Peanuts with gypsy moth egg masses, see [T313-a](#)

Pinus from Canada to certain States, see [T201-j Pines \(*Pinus* spp.\) From Canada \(destined to California, Idaho, Oregon, and Utah\)](#)

NOTICE

Some species and varieties of evergreens, particularly in *Azalea* and *Juniperus* have low tolerances and should be fumigated as in schedule T201-c; those known to be intolerant should be handled under T201-p. For tolerance data, see *Handbook of Plant Tolerances to Quarantine Treatments*.

T201-k-1 Foliated Host Plants of *Dialeurodes citri* (Citrus Whitefly), Excluding *Osmanthus americanus*

For *Osmanthus americanus*, see T201-p

Pest: *Dialeurodes citri* (citrus whitefly)

Treatment: T201-k-1 MB (“Q” label only) at NAP

Temperature (°F)	Dosage Rate (lb/1,000 ft ³):		Exposure Period (hours)
	<i>Otiiorhynchus</i> (formerly <i>Brachyrhinus</i>) larvae	All others	
85-96	1.5	1	4
80-84	2.5	2	2.5
70-79	2.0	2	3.5

T201-c-1 Greenhouse-Grown Plants, Herbaceous Plants and Cuttings, and Greenwood Cuttings of Woody Plants

For cut flowers and greenery, use [T305-a Cut flowers and greenery](#) on page 5-4-20.

Pest: External feeders, leaf miners¹, mealybugs², thrips

Treatment: T201-c-1 MB (“Q” label only) at NAP—tarpaulin or chamber

Temperature (°F)	Dosage Rate (lb/1,000 ft ³)	Minimum Concentration Readings (ounces) At:	
		0.5 hr	2 hrs
80-90	1.5	19	12
70-79	2.0	24	16
60-69 ²	2.5	30	20
50-59	3.0	36	24
40-49	3.5	41	27
40-49 ¹	4	48	38

1 If treating for leaf miners at 40-49 °F, use the dosage rate of 4.0 lbs./1000 ft³.

2 If treating for mealybugs, treat **only** at or above 60 °F (2.5 lbs.).

T201-c-2 Greenhouse-Grown Plants, Herbaceous Plants and Cuttings, and Greenwood Cuttings of Woody Plants

For cut flowers and greenery, use [T305-b Cut flowers and greenery](#) on page 5-4-21.

Pest: Borers, soft scales

Treatment: T201-c-2 MB (“Q” label only) in 15” vacuum

Temperature (°F)	Dosage Rate (lb/1,000 ft ³)	Exposure Period (hours)
80-90	2.5	2
70-79	3.0	2
60-69	3.0	2.5
50-59	3.0	3
40-49	3.0	3.5

Vacuum fumigation requires prior consent of the importer. If consent is denied, refuse entry unless T201-c-1, plus hand removal of these pests is feasible. For consignments of a size to permit 100 percent inspection, plants with these pests may be handled separately. Vacuum fumigation is **not** required for soft scales known to be widely distributed in the United States.

NOTICE

Exceptions to Schedules T201-c-1 and T201-c-2:

- Bromeliads, see [T201-e-3-1 Pineapple Slips](#)
- Cacti and other succulents, see [T201-f-2 Cacti and Other Succulents](#)
- Chrysanthemum* spp., see [T201-g-1 Chrysanthemum spp., Rooted and Unrooted Cuttings](#)
- Cycads, see [T201-l Commodities Infested with Quarantine-Significant Slugs](#)
- Cyclamen mites, see [T201-a-2 Deciduous Woody Plants \(Dormant\)](#)
- Dieffenbachia* spp, *Dracaena* spp., and *Philodendron* spp., see [T201-i-1 Dieffenbachia spp., Dracaena spp., Philodendron spp. \(Plants and Cuttings\)](#)
- Kalanchoe synsepala*, see [T201-p-1 Plant Material Not Tolerant to Fumigation](#)
- Lavandula* spp., see [T201-p-2 Plant Material Not Tolerant to Fumigation](#)
- Orchids, see [T201-d-1 Orchids, Plants, and Cuttings \(Dormant or Nondormant\)](#)
- Osmanthus americanus*, see [T201-p Plant Material Not Tolerant to Fumigation](#)
- Pelargonium* spp., see [T201-p Plant Material Not Tolerant to Fumigation](#)
- Sedum adolphi*, see [T201-p Plant Material Not Tolerant to Fumigation](#)
- Plants infested with *Succinea horticola*, see [T201-o-1 Host Plants of Omalonyx spp. and Succinea spp. \(Snails\)](#)
- Plants infested with *Veronicella* or other slugs, see [T201-l Commodities Infested with Quarantine-Significant Slugs](#)

T201-n Host Plants of *Aleurocanthus woglumi* (Citrus Blackfly)

Pest: *Aleurocanthus woglumi* (citrus blackfly)

Treatment: T201-n MB (“Q” label only) at NAP—tarpaulin or chamber

Temperature (°F)	Dosage Rate (lb/1,000 ft ³)	Minimum Concentration Readings (ounces) At:	
		0.5 hr	2 hrs
85 and above	1.0	13	9
80-85	1.25	16	12
70-79	1.5	19	15
65-69	1.75	23	17

Precautions within citrus blackfly quarantine areas:

- ◆ Conduct tarpaulin fumigations in shaded areas, if possible, to prevent the development of high space temperatures within the tarpaulin enclosure.
- ◆ Fumigate 4 to 5 days after plants are dug, balled, and burlapped, if possible.
- ◆ Roots and soil should be moist prior to fumigation. Watering should be deferred for 12 hours after fumigation unless there is wilting, in which case, water as needed.
- ◆ Avoid excessive air circulation during fumigation or during the post-treatment aeration period.
- ◆ Avoid placing plants in direct sunlight after fumigation.

T201-o-1 Host Plants of *Omalonyx spp.* and *Succinea spp.* (Snails)

NOTICE

Use T201-o-1 on plants that may **not** tolerate fumigation.

Pest: *Omalonyx spp.* and *Succinea spp.* (snails)

Treatment: T201-o-1 Water Spray—Use a high-pressure water spray on the foliage to flush snails from the plants. Do **not** spray the root systems of conifers since they will be damaged. Screen the run-off drain to catch snails before drainage into the sewer system. Reinspect plants after wash.

T201-o-2 Host Plants of *Omalonyx* spp. and *Succinea* spp. (Snails)

DO NOT USE this treatment schedule.
The schedule is not authorized for use and
will be removed or revised following a
Federal Register notice according to
7 CFR 305.3.

May 01, 2012

Treatment: T201-o-2 Chemical Dip—Dip plants with a Malathion-carbaryl chemical dip. Solution prepared by adding 3 level tablespoons of 25 percent Malathion wettable powder and 6 level tablespoons of 50 percent carbaryl wettable powder per gallon of water with a sticker-spreader formulation.

T201-k-2 Nonfoliated Host Plants of *Dialeurodes citri* (Citrus Whitefly), Excluding *Osmanthus americanus*

Pest: *Dialeurodes citri* (citrus whitefly)

Treatment: T201-k-2 MB (“Q” label) at NAP

Temperature (°F)	Dosage Rate (lb/1,000 ft ³)	Exposure Period (hours)	
		<i>Otiorhynchus</i> (formerly <i>Brachyrhinus</i>) larvae	All Others
90-96	2.0	2.5	2
80-89	2.5	2.5	2
70-79	3.0	2.5	2
60-69	3.0	3	2.5
50-59	3.0	3.5	3
40-49	3.0	4	3.5

T201-d-1 Orchids, Plants, and Cuttings (Dormant or Nondormant)

Pest: External feeders, other than soft scales

Treatment: T201-d-1 MB (“Q” label only) at NAP—tarpaulin or chamber

Temperature (°F)	Dosage Rate (lb/1,000 ft ³)	Exposure Period (hours)	
		<i>Otiorhynchus</i> (formerly <i>Brachyrhinus</i>) larvae	All Others
90-96	2.0	2.5	2
80-89	2.5	2.5	2
70-79	3.0	2.5	2
60-69	3.0	3	2.5
50-59	3.0	3.5	3
40-49	3.0	4	3.5

NOTICE

Some varieties of Orchids may be sensitive to MB treatments. These varieties include *Cymbidium*, *Cypripedium*, and *Phalaenopsis*. For alternatives, see [T201-p Plant Material Not Tolerant to Fumigation](#).

NOTICE

If treating for mealybugs, use [T305-c Cut flowers and greenery](#) on page 5-4-21.

T201-d-2 Orchids, Plants, and Cuttings

Pest: External feeders (other than soft scales) infesting greenhouse-grown plant material

Treatment: T201-d-2 MB (“Q” label only) at NAP—tarpaulin or chamber

Temperature (°F)	Dosage Rate (lb/1,000 ft ³)	Exposure Period (hours)
90-96	1.0	2
80-89	1.5	2
70-79	2.0	2
60-69	2.5	2
50-59	3.0	2
40-49	3.5	2

T201-d-3 Orchids, Plants, and Cuttings

Pest: Borers, cattleya fly, *Mordellistena* spp., soft scales, *Vinsonia* spp.

Treatment: T201-d-3 MB (“Q” label only) in 15” vacuum

Temperature (°F)	Dosage Rate (lb/1,000 ft ³)	Exposure Period (hours)
90-96	3.0	1
80-89	3.0	1.5
70-79	3.0	2
60-69	3.0	2.5
50-59	3.0	3
40-49	3.0	3.5

For nondormant plants, collected or greenhouse grown, vacuum fumigation requires prior consent of the importer. If consent is denied, REFUSE entry unless T201-a-1 plus hand removal of these pests is feasible. Plant consignments of a size to permit 100 percent inspection and pest removal may be handled separately.

T201-d-4 Orchids, Plants, and Cuttings

Pest: Cecidomyid galls

Treatment: T201-d-4 Excised in all cases

T201-d-5 Orchids, Plants, and Cuttings

Pest: Leaf miner, *Eurytoma* spp., infesting *Rhynchostylis*

Treatment: T201-d-5 Hot water—118 °F for 0.5 hour followed by a cool water bath

T201-e-3-1 Pineapple Slips

Pest: Various

Treatment: T201-e-3-1 MB (“Q” label only) at NAP

Temperature (°F)	Dosage Rate (lb/1,000 ft ³)	Exposure Period (hours)
90-96	1.5	2
80-89	2.0	2
70-79	2.5	2
60-69	3.0	2

T201-e-3-2 Pineapple Slips

Treatment: T201-e-3-2 MB (“Q” label only) in 26” vacuum

Temperature (°F)	Dosage Rate (lb/1,000 ft ³)	Exposure Period (hours)
90-96	1.5	1.5
80-89	2.0	1.5
70-79	2.5	1.5
60-69	3.0	1.5

NOTICE

Some varieties of bromeliads may be sensitive to methyl bromide (MB) treatments. These varieties include *Aechmea* spp., *Billbergia* spp., *Guzmania* spp., *Nidularium* spp., *Vriesea* spp., and other broad shiny-leafed types, and thin-leafed types. For alternatives, see [T201-p Plant Material Not Tolerant to Fumigation](#).

T201-j Pines (*Pinus* spp.) From Canada (destined to California, Idaho, Oregon, and Utah)

Pest: *Rhyacionia buoliana* (European pine shoot moth)

Treatment: T201-j MB (“Q” label only) at NAP

Dosage rate for all schedules is 4 lbs. MB (51 oz. minimum concentration)

Temperature (°F)	Exposure Period	Temperature (°F)	Exposure Period
75	2 hrs	59	2 hrs 41 min
74	2 hrs 1 min	58	2 hrs 43 min
73	2 hrs 2 min	57	2 hrs 46 min
72	2 hrs 4 min	56	2 hrs 49 min
71	2 hrs 7 min	55	2 hrs 52 min
70	2 hrs 9 min	54	2 hrs 55 min
69	2 hrs 11 min	53	2 hrs 58 min
68	2 hrs 14 min	52	3 hrs 1 min
67	2 hrs 16 min	51	3 hrs 5 min
66	2 hrs 19 min	50	3 hrs 8 min
65	2 hrs 22 min	49	3 hrs 12 min
64	2 hrs 25 min	48	3 hrs 15 min
63	2 hrs 28 min	47	3 hrs 19 min
62	2 hrs 31 min	46	3 hrs 24 min
61	2 hrs 35 min	45	3 hrs 28 min
60	2 hrs 38 min		

NOTICE

This is a precautionary treatment for pine trees with or **without** roots and twigs and branches of all *Pinus* species. Christmas trees and other pine decorative materials are exempt from the fumigation requirement during the period November 1 through December 31.

Prior consent of the importer is required for fumigation at temperatures above 65 °F or below 50 °F and also for all bare-rooted pines, since some damage may occur.

T201-m-1 Plant Cuttings (Scion Wood)

Exceptions to plant cuttings include avocado (T201-p), Chrysanthemum (T201-p), Dieffenbachia (T201-g), Dracaena (T201-i), Lavandula (T201-p), Orchid (T201-d), Philodendron (T201-i).

Pest: External feeders

Treatment: T201-m-1 MB (“Q” label only) at NAP—tarpaulin or chamber

Temperature (°F)	Dosage Rate (lb/1,000 ft ³)	Exposure Period (hours)	
		<i>Otiorhynchus</i> (formerly <i>Brachyrhinus</i>) larvae	All Others
90-96	2.0	2.5	2
80-89	2.5	2.5	2
70-79	3.0	2.5	2
60-69	3.0	3	2.5
50-59	3.0	3.5	3
40-49	3.0	4	3.5

T201-m-2 Plant Cuttings (Greenwood Cuttings of Woody Plants and Herbaceous Plant Cuttings)

Exceptions to plant cuttings include avocado (T201-p), Chrysanthemum (T201-p), Dieffenbachia (T201-g), Dracaena (T201-i), Lavandula (T201-p), Orchid (T201-d), Philodendron (T201-i).

Pest: External feeders

Treatment: T201-m-2 MB (“Q” label only) at NAP—tarpaulin or chamber

Temperature (°F)	Dosage Rate (lb/1,000 ft ³)	Minimum Concentration Readings (ounces) At:	
		0.5 hr	2 hrs
80-90	1.5	19	12
70-79	2.0	24	16
60-69	2.5	30	20
50-59	3.0	36	24
40-49	3.5	41	27

T201-m-3 Plant Cuttings (Root Cuttings)

Exceptions to plant cuttings include avocado (T201-p), Chrysanthemum (T201-p), Dieffenbachia (T201-g), Dracaena (T201-i), Lavandula (T201-p), Orchid (T201-d), Philodendron (T201-i).

Pest: External feeders

Treatment: T201-m-3 MB (“Q” label only) at NAP—chamber

Temperature (°F)	Dosage Rate (lb/1,000 ft ³)	Exposure Period (hours)	
		<i>Otiorhynchus</i> (formerly <i>Brachyrhinus</i>) larvae	All Others
90-96	2.0	2.5	2
80-89	2.5	2.5	2
70-79	3.0	2.5	2
60-69	3.0	3	2.5
50-59	3.0	3.5	3
40-49	3.0	4	3.5

T201-m-4 Plant Cuttings (Root Cuttings)

Exceptions to plant cuttings include avocado (T201-p), Chrysanthemum (T201-p), Dieffenbachia (T201-g), Dracaena (T201-i), Lavandula (T201-p), Orchid (T201-d), Philodendron (T201-i).

Pest: External feeders

Treatment: T201-m-4 MB (“Q” label only) at NAP—tarpaulin

Temperature (°F)	Dosage rate (lb/1,000 ft ³)	Minimum Concentration Readings (ounces) At:				
		0.5 hr	2.5 hrs	3 hrs	3.5 hrs	4 hrs
90-96	2.0	24	16	–	–	–
80-89	2.5	30	20	–	–	–
70-79	3.0	36	24	–	–	–
60-69	3.0	36	–	24	–	–
50-59	3.0	36	–	–	24	–
40-49	3.0	36				24

T201-p Plant Material Not Tolerant to Fumigation

Three treatments based on pest

Propagative material known to be sensitive to fumigation (see *Handbook of Plant Tolerance to Quarantine Treatments*) should be handled using T201-p-1 or T201-p-4. The selection of the method will depend upon the character of the plant material and the type of pests that may be found.

T201-p-1 Plant Material Not Tolerant to Fumigation

Pest: Actionable pests excluding scale insects

Treatment: T201-p-1 Hand removal—With the exception of scale insects, hand remove pests or infested parts and inspect closely to ensure plants are pest free. If the characteristics of the plant growth, volume, or the type of pest are such that hand removal plus inspection may **not** provide a pest-free consignment, then see [T201-p-4 Plant Material Not Tolerant to Fumigation](#) on page 5-3-21.

T201-p-2 Plant Material Not Tolerant to Fumigation

**DO NOT USE this treatment schedule.
The schedule is not authorized for use and
will be removed or revised following a
Federal Register notice according to
7 CFR 305.3.**

May 01, 2012

Pest: Actionable Pests

Treatment: T201-p-2 Hand removal plus chemical dip—Hand removal of pests of infested parts *plus* a malathion/carbaryl chemical dip. Solution prepared by adding 3 level tablespoons of 25 percent malathion wettable powder and 3 level tablespoons of 50 percent carbaryl wettable powder to each gallon of water. The addition of a sticker-spreader formulation may be required for hard to wet plants. Use fresh chemicals and prepare dip for the same day use. Plants, including the roots, should be entirely submerged in the chemical dip for 30 seconds.

NOTICE

When the actionable pests are scale insects or their immature crawlers, prepare the solution by adding 4 level tablespoons of 25 percent malathion wettable powder (if the label allows) and 3 level tablespoons of 50 percent carbaryl wettable powder to each gallon of water. Labels registered for this concentration are currently available from the following companies:

Micro-Flo Company LLC
530 Oak Court Drive, Suite 100
Memphis, TN 38117
Product: Malathion 25-WP
EPA Registration No. 051036-00033
Phone: (901) 432-5000

Cheminova Inc.
Oak Hill Park
1700 Route 23, Suite 210
Wayne, NJ 07470
Product: Fyfanon 25 WP
EPA Registration No. 067760-00016
Phone: (201) 305-6600

T201-p-3 Plant Material Not Tolerant to Fumigation—Deleted (Docket APHIS-13-009-2, July 21, 2015)

T201-p-4 Plant Material Not Tolerant to Fumigation

Pests:

Insects (Aphididae, Thripidae, Formicidae, Coccidae, Pseudococcidae, Diaspididae, Pyralidae, Tortricidae, Syrphidae, Scarabaeidae, Curculionidae, Tenebrionidae)

Snails (Ampullariidae, Planorbidae)

Mites (Acaridae, Tarsonemidae, Tetranychidae, Tydeidae)

Nematodes (Pratylenchus (genus only))

Treatment: T201-p-4 Hand removal plus hot water treatment—Hot water at 52 °C/125 °F for 30 minutes

If hand removal is not feasible, allow the importer to fumigate at their own risk or return the commodity to the country of origin.

Under Development: See [Plant Material Not Tolerant to Fumigation](#) on page 3-3-16 for operational guidance and equipment specifications.

T202—Bulbs, Corms, Tubers, Rhizomes, and Roots

T202-b Astilbe Roots

Pest: *Otiorhynchus* (formerly *Brachyrhinus*) larvae

Treatment: T202-b MB (“Q” label only) in 26” vacuum

Temperature (°F)	Dosage Rate (lb/1,000 ft ³)	Exposure Period (hours)
70-96	4.0	2
60-69	4.0	2.5
50-59	4.0	3
40-49	4.0	4

For roots received in large cases packed in peat moss, temperatures apply to packing materials, if lower than root temperatures.

T202-c Banana Roots

Pest: External feeders

Treatment: T202-c Hot water—110 °F for 30 minutes as pretreatment followed by 120 °F for 60 minutes. Requires consent of importer. REFUSE entry **without** consent unless 100 percent inspection plus pest removal is feasible.

T202-j Garlic

Pest: *Brachycerus* spp. (garlic beetles) and *Dyspessa ulula* (Bkh.) (onion/garlic carpenterworm)

Treatment: T202-j MB (“Q” label only) in 15” vacuum (load limit not to exceed 80 percent of the chamber)

Temperature (°F)	Dosage Rate (lb/1,000 ft ³)	Exposure Period (hours)
90-96	2.0	1.5
80-89	2.0	2
70-79	2.5	2
60-69	3.0	2
50-59	3.0	3
40-49	3.0	4

T202-j-1 Garlic

Pest: *Brachycerus* spp. (garlic beetles) and *Dyspessa ulula* (Bkh.) (onion/garlic carpenterworm)

Treatment: T202-j-1 MB at NAP—tarpaulin or chamber

Temperature (°F)	Dosage Rate (lb/1,000 ft ³)	Minimum Concentration Readings (ounces) At:				
		0.5 hr	2 hrs	2.5 hrs	3 hrs	3.5 hrs
90 and above	2.0	26	19	–	–	–
80-89	2.5	32	24	–	–	–
70-79	3.0	38	29	–	–	–
60-69	3.0	38	26	26	–	–
50-59	3.0	38	26	–	26	–
40-49	4.0	38	26	–	–	26

T202-e-1 *Gladiolus* spp.

Pest: *Taeniothrips simplex* (gladiolus thrips)

Treatment: T202-e-1 MB (“Q” label only) at NAP

Temperature (°F)	Dosage Rate (lb/1,000 ft ³)	Exposure Period (hours)
90-96	2.0	3
80-89	2.5	3
70-79	3.0	3
60-69	3.0	3.5
50-59	3.0	4
40-49	3.0	4.5

T202-e-2 *Gladiolus* spp.

Pest: *Taeniothrips simplex* (gladiolus thrips)

Treatment: T202-e-2 MB (“Q” label only) in 26” vacuum

Temperature (°F)	Dosage Rate (lb/1,000 ft ³)	Exposure Period (hours)
90-96	2.0	2
80-89	2.5	2
70-79	3.0	2
60-69	3.0	2.5
50-59	3.0	3
40-49	3.0	3.5

T202-f Horseradish Roots

Pest: External feeders

Treatment: T202-f MB in 15" vacuum

Temperature (°F)	Dosage Rate (lb/1,000 ft ³)	Exposure Period (hours)	
		<i>Otiorhynchus</i> (formerly <i>Brachyrhinus</i>) larvae	All Others
90-96	2.0	2.5	2
80-89	2.5	2.5	2
70-79	3.0	2.5	2
60-69	3.0	3	2.5
50-59	3.0	3.5	3
40-49	3.0	4	3.5

T202-g Lily Bulbs Packed in Subsoil

Pest: Internal feeders

Treatment: T202-g MB ("Q" label only) at NAP

Temperature (°F)	Dosage Rate (lb/1,000 ft ³)	Exposure Period (hours)
90-96	2.0	3
80-89	2.5	3
70-79	3.0	3
60-69	3.0	3.5
50-59	3.0	4
40-49	3.0	4.5

Load limit 50 percent of chamber volume. Remove all wooden case covers. Overnight or longer aeration advisable.

T202-h Lycoris

Pest: *Taeniothrips eucharii*

Treatment: T202-h MB in 26" vacuum

Temperature (°F)	Dosage Rate (lb/1,000 ft ³)	Exposure Period (hours)	
		<i>Otiorhynchus</i> (formerly <i>Brachyrhinus</i>) larvae	All Others
90-96	2.0	2.5	2
80-89	2.5	2.5	2
70-79	3.0	2.5	2
60-69	3.0	3	2.5
50-59	3.0	3.5	3
40-49	3.0	4	3.5

T202-i-1 Narcissus

Pest: *Steneotarsonemus laticeps* (bulb scale mite)

Treatment: T202-i-1 MB ("Q" label only) at NAP

Temperature (°F)	Dosage Rate (lb/1,000 ft ³)	Exposure Period (hours)
90-96	3.0	2
80-89	3.5	2
70-79	4.0	2
60-69	4.0	2.5
50-59	4.0	3
40-49	4.0	3.5

T202-i-2 *Narcissus*

Pest: *Steneotarsonemus laticeps* (bulb scale mite)

Treatment: T202-i-2 MB (“Q” label only) in 26” vacuum chamber

Temperature (°F)	Dosage Rate (lb/1,000 ft ³)	Exposure Period (hours)
90-96	2.0	2
80-89	2.5	2
70-79	3.0	2
60-69	3.0	2.5
50-59	3.0	3
40-49	3.0	3.5

T202-i-3 *Narcissus*

Pest: *Steneotarsonemus laticeps* (bulb scale mite)

Treatment: T202-i-3 Hot water, 110-111 °F for 1 hour

NOTICE

Exposure measured from time bulbs reach 110 °F pulp temperature. Hot water should be applied *within 1 month after normal harvest*, or flower bud injury may develop.

T202-a-1 *Selaginella* spp. (Resurrection Plants)

Pest: External feeders

Treatment: T202-a-1 MB (“Q” label only) at NAP—chamber

Temperature (°F)	Dosage Rate (lb/1,000 ft ³)	Exposure Period (hours)	
		<i>Otiorhynchus</i> (formerly <i>Brachyrhinus</i>) larvae	All Others
90-96	2.0	2.5	2
80-89	2.5	2.5	2
70-79	3.0	2.5	2
60-69	3.0	3	2.5
50-59	3.0	3.5	3
40-49	3.0	4	3.5

T202-a-2 Selaginella spp. (Resurrection Plants)

Pest: External feeders

Treatment: T202-a-2 MB (“Q” label only) at NAP—tarpaulin

Temperature (°F)	Dosage rate (lb/1,000 ft ³)	Minimum Concentration Readings (ounces) At:				
		0.5 hr	2.5 hrs	3 hrs	3.5 hrs	4 hrs
90-96	2.0	24	16	–	–	–
80-89	2.5	30	20	–	–	–
70-79	3.0	36	24	–	–	–
60-69	3.0	36	–	24	–	–
50-59	3.0	36	–	–	24	–
40-49	3.0	36				24

T202-a-3 Selaginella spp. (Resurrection Plants)

Pest: Internal feeders

Treatment: T202-a-3 MB (“Q” label only) in 26” vacuum—chamber

Temperature (°F)	Dosage Rate (lb/1,000 ft ³)	Exposure Period (hours)	
		<i>Otiorhynchus</i> (formerly <i>Brachyrhinus</i>) larvae	All Others
90-96	2.0	2.5	2
80-89	2.5	2.5	2
70-79	3.0	2.5	2
60-69	3.0	3	2.5
50-59	3.0	3.5	3
40-49	3.0	4	3.5

T202-d Yams (*Dioscorea* spp.) and Sweet Potatoes (*Ipomoea* spp.)

Pest: Internal and external feeders

Treatment: T202-d MB (“Q” label only) at NAP—tarpaulin

Temperature (°F)	Dosage Rate (lb/1,000 ft ³)	Minimum Concentration Readings (ounces) At:		
		0.5. hr	2 hrs	4 hrs
90 and above	2.5	32	20	20
80-89	3.0	38	24	24
70-79	3.5	44	28	28
60-69	4.0	50	32	32

CAUTION

Temperatures below 70 °F may cause injury to yams. Fumigations below 70 °F should only be made with consent of importer. The tuberous roots should be cured, free from surface moisture, and held at fumigation temperatures for 24 hours following treatment.

T203—Seeds

NOTICE

Any seed listed in other import manuals as requiring treatment, regardless of exception or waiver, is **not** eligible for a Small Lots of Seed (SLS) permit.

⚠ CAUTION

MB fumigation may effect germination. Obtain the importers consent prior to fumigation.

T203-m Avocado (Seeds Only Without Pulp)

Pest: Avocado seed weevils (*Conotrachelus* spp., *Heilipus lauri*, and *Caulophilus latinasus*); avocado stem weevil (*Copturus aguacatae*), and avocado seed moth (*Stenomoma catenifer*)

Treatment: T203-m MB (“Q” label only) in 26” vacuum

Temperature (°F)	Dosage Rate (lb/1,000 ft ³)	Exposure Period (hours)
90-96	2.0	2
80-89	3.0	2
70-79	4.0	2
60-69	4.0	3
50-59	4.0	4
40-49	4.0	5

T203-e Chestnuts (Excludes Water Chestnuts) and Acorns

From all countries **except** Canada and Mexico

Pest: Internal feeders

Treatment: T203-e MB (“Q” label only) in 26” vacuum

Temperature (°F)	Dosage Rate (lb/1,000 ft ³)	Exposure Period (hours)
80-96	3.0	2
70-79	4.0	2
60-69	4.0	3
50-59	4.0	4
40-49	4.0	5

T203-e-1 Chestnuts (Excludes Water Chestnuts) and Acorns

Pest: *Cydia splendana* (nut fruit tortrix) and *Curculio* spp.

Treatment: T203-e-1 MB at NAP—tarpaulin or chamber

Temperature (°F)	Dosage Rate (lb/1,000 ft ³)	Minimum Concentration Readings (ounces) At:					
		0.5 hr	2 hrs	3 hrs	4 hrs	5 hrs	6 hrs
90 and above	4.0	58	34	34	–	–	–
80-89	4.0	58	32	–	32	–	–
70-79	5.0	72	42	–	42	–	–
60-69	5.0	72	40	–	–	40	–
50-59	6.0	85	50	–	–	50	–
40-49	6.0	85	48	–	–	–	48

NOTICE

It is a label violation to treat acorns at dosage rates greater than 4 lbs. Treat acorns only at 80 °F or above.

T203-i-1 Conifer Seeds (Species with Small Seeds, Such as *Picea* spp., *Pinus sylvestris*, and *Pinus mugo*)

For species with small seeds, such as *Picea* spp., *Pinus sylvestris*, and *Pinus mugo* in bags containing 75 lbs., draw an initial vacuum of at least 24 inches. Once the MB is introduced, reduce the vacuum to NAP. This procedure is necessary for efficient penetration and distribution of the fumigant. Conifer seeds in bags of more than 75 lbs. each should be aerated in a well ventilated area for 24 hours, small seeds should be aerated for 48 hours.

Pest: External feeders

Treatment: T203-i-1 MB (“Q” label only) at NAP

Temperature (°F)	Dosage Rate (lb/1,000 ft ³)	Exposure Period (hours)
80-96	2.5	2.5
70-79	3.0	2.5
60-69	3.0	3
50-59	3.0	3.5
40-49	3.0	4

NOTICE

Load limit is 30 percent of chamber space. Moisture should **not** be added in fumigation of dry seeds.

T203-i-2 Conifer Seeds (Species With Small Seeds, Such as *Picea* spp., *Pinus sylvestris*, and *Pinus mugo*)

Pest: Internal feeders, nutlike seeds, or when seeds are tightly packed so as to make fumigant penetration questionable.

Treatment: T203-i-2 MB (“Q” label only) in 26” vacuum

Temperature (°F)	Dosage Rate (lb/1,000 ft ³)	Exposure Period (hours)
80-96	2.5	2.5
70-79	3.0	2.5
60-69	3.0	3
50-59	3.0	3.5
40-49	3.0	4

NOTICE

Load limit is 50 percent of chamber space. Plastic or impermeable liners should be removed or well perforated. This schedule is **not** entirely effective against some species of Chalcid wasps.

T203-i-3 Conifer Seeds (Species with Small Seeds, Such as *Picea* spp., *Pinus sylvestris*, and *Pinus mugo*)

Pest: External feeders

Treatment: T203-i-3 MB (“Q” label only) tarpaulin

The yellow color of the treatment indicates that the authority to conduct the treatment comes from an emergency action required by PPQ in order to mitigate the pest risk. The emergency action is an interim measure and is pending final regulatory approval.

Temperature (°F)	Dosage Rate (lbs./1000 ft ³)	Minimum Concentration Readings (ounces) At (x) hours:						
		0.5	2	4	5	6	8	10
80-96	2.5	30	25	25	—	—	—	—
70-79	3.0	36	30	25	18			
60-69	3.0	36	30	25	—	17	—	—
50-59	3.0	36	30	25		17	17	
40-49	3.0	36	30	25	—	17	17	17

NOTICE

The commodity must not exceed 30 percent of the entire tarped enclosure. Refer to [Fumigants—Methyl Bromide—Tarpaulin Fumigation](#) for instructions on calculating the enclosure size. Do not add moisture when fumigating dry seeds. Normally, dry seed shipments arriving in wet or damp conditions may be injured.

T203-f-1 Cottonseed—Bagged, Packaged, or in Bulk

Pest: External feeders

Treatment: T203-f-1 MB (“Q” label only) at NAP—chamber

Temperature (°F)	Dosage Rate (lb/1,000 ft ³)	Exposure Period (hours)
60 and above	6.0	12
	3.0	24
40-59	7.0	12
	4.0	24

NOTICE

Load limit is 50 percent of chamber volume.

T203-f-2 Cottonseed—Bagged, Packaged, or in Bulk

Pest: External feeders

Treatment: T203-f-2 MB (“Q” label only) at NAP—tarpaulin

Temperature (°F)	Dosage Rate (lb/1,000 ft ³)	Minimum Concentration Readings (ounces) At:			
		0.5 hr	2 hrs	12 hrs	24 hrs
60 and above	7.0	54	56	27	–
	5.0	40	40	–	20
40-59	8.0	64	64	32	–
	6.0	48	48	–	24

T203-f-3 Cottonseed—Bagged, Packaged, or in Bulk

Pest: External feeders

Treatment: T203-f-3 MB (“Q” label only) in 26” vacuum—chamber

Temperature (°F)	Dosage Rate (lb/1,000 ft ³)	Exposure Period (hours)
40 and above	4.0	2

NOTICE

Load limit is 50 percent of chamber volume.

T203-f-4 Cottonseed—Bagged, Packaged, or in Bulk

Pest: External feeders

Treatment: T203-f-4 Phosphine at NAP

Temperature (°F)	Dosage Rate (gms/1,000 ft ³)	Minimum Concentration Readings (ppm) At:	
		72 hrs	120 hrs
50 and above	60 ¹ g	225 ²	50 or above

- 1 60 g/1,000 ft³ (28.3 m³) is equivalent to 2.1 g/m³
- 2 An average reading with **no** reading less than 50 ppm

Relative humidity **must** be 40 percent or higher when commodity enclosed.

Aerate minimum of 24 hours.

T203-g-1 Pods and Seeds of Kenaf, Hibiscus, and Okra

Pest: Internal feeders

Treatment: T203-g-1 MB (“Q” label only) at NAP—tarpaulin or chamber

Temperature (°F)	Dosage Rate (lb/1,000 ft ³)	Minimum Concentration Readings (ounces) At:		
		0.5 hr	12 hrs	24 hrs
60-96	2.0	24	12	–
	1.0	12	–	5
40-59	3.0	36	17	–
	2.0	24	–	10

T203-g-2 Pods and Seeds of Kenaf, Hibiscus, and Okra

Pest: Internal feeders

Treatment: T203-g-2 MB (“Q” label only) in 26” vacuum—chamber (kenaf and okra seed only)

Temperature (°F)	Dosage Rate (lb/1,000 ft ³)	Exposure Period (hours)
40 and above	4.0	2

NOTICE

Load limit is 50 percent of chamber volume.

T203-g-3 Pods and Seeds of Kenaf, Hibiscus, and Okra

Pest: Internal feeders

Treatment: T203-g-3 Phosphine at NAP

Temperature (°F)	Dosage Rate (gms/1,000 ft ³)	Minimum Concentration Readings (ppm) At:	
		72 hrs	120 hrs
50 and above	60 ¹	225 ²	50 or above

1 60 g/1,000 ft³ (28.3 m³) is equivalent to 2.1 g/m³

2 An average reading with **no** reading less than 50 ppm

Relative humidity **must** be 40 percent or higher when commodity enclosed.

Aerate minimum of 24 hours.

T203-k Macadamia Nuts (as Seeds)

Pest: *Cryptophlebia illepidia* (koa seedworm)

Treatment: T203-k MB (“Q” label only) at NAP

Temperature (°F)	Dosage Rate (lb/1,000 ft ³)	Exposure Period (hours)
70 and above	2.0	2
60-69	2.5	2
50-59	3.0	2
40-49	3.5	2

T203-k-1 Macadamia Nuts (as Seeds)

Pest: *Cryptophlebia illepipa* (koa seedworm)

Treatment: T203-k-1 MB (“Q” label only) tarpaulin

The yellow color of the treatment indicates that the authority to conduct the treatment comes from an emergency action required by PPQ in order to mitigate the pest risk. The emergency action is an interim measure and is pending final regulatory approval.

Temperature (°F)	Dosage Rate (lbs./1000 ft ³)	Minimum Concentration Readings (ounces) At (x) hours:		
		0.5	2	4
70-79	2.0	24	16	16
60-69	2.5	30	20	20
50-59	3.0	36	24	24
40-49	3.5	42	28	28

NOTICE

The commodity must not exceed 30 percent of the entire tarped enclosure. Refer to [Fumigants—Methyl Bromide—Tarpaulin Fumigation](#) for instructions on calculating the enclosure size. Do not add moisture when fumigating of dry seeds. Normally, dry seed shipments arriving in wet or damp conditions may be injured.

T203-h Rosmarinus Seeds

Pest: Juvenile *Helicella* spp. (snails) or internal feeders

Treatment: T203-h MB (“Q” label only) at 26” vacuum

Temperature (°F)	Dosage Rate (lb/1,000 ft ³)	Exposure Period (hours)
70 and above	4.0	4

T203-l Seeds

Pest: *Trogoderma granarium* (khapra beetle)

Treatment: T203-l MB (“Q” label only) at NAP—tarpaulin or chamber

Temperature (°F)	Dosage Rate (lb/1,000 ft ³)	Minimum Concentration Readings (ounces) At:			
		0.5 hr	2 hrs	4 hrs	12 hrs
90 and above	2.5	30	20	20	15
80-89	3.5	42	30	30	20

T203-b Seeds Excluding Seeds of *Vicia* spp.

Pest: Bruchidae (seed beetles)

Treatment: T203-b MB (“Q” label only) in 26” vacuum

Temperature (°F)	Dosage Rate (lb/1,000 ft ³):		Exposure Period (hours)	
	<i>Caryedon</i> spp.	All others	<i>Caryedon</i> spp.	All others
70-96	5.0	3.0	2	2.5
60-69	–	3.0	–	3
50-59	–	3.0	–	3.5
40-49	–	3.0	–	4

NOTICE

As of October 2008, **no** commercial chambers in the United States are approved for the vacuum fumigation of imported commodities. If vacuum treatment is required as a condition of entry, the consignment **must** be destroyed, reexported, or returned to country of origin.

T203-o (deleted)

T203-a-1 Seeds Not Specifically Listed in the T203 Schedules

Pest: External feeders

Treatment: T203-a-1 MB (“Q” label only) at NAP

Temperature (°F)	Dosage Rate (lb/1,000 ft ³)	Exposure Period (hours)
80-96	2.5	2.5
70-79	3.0	2.5
60-69	3.0	3
50-59	3.0	3.5
40-49	3.0	4

Load limit is 30 percent of chamber space. Moisture should **not** be added in fumigation of dry seeds. Normally, dry seed consignments arriving in wet or damp condition may be injured. This schedule may scald coconut husks. (Some tropical or nutlike seeds are usually shipped damp.)

T203-a-2 Seeds Not Specifically Listed in the T203 Schedules

Pest: Internal feeders, **except** *Megastigmus* spp.

Treatment: T203-a-2 MB (“Q” label only) in 26” vacuum

Temperature (°F)	Dosage Rate (lb/1,000 ft ³)	Exposure Period (hours)
80-96	2.5	2.5
70-79	3.0	2.5
60-69	3.0	3
50-59	3.0	3.5
40-49	3.0	4

NOTICE

Load limit is 50 percent of chamber space. Plastic or impermeable liners should be removed or well perforated.

NOTICE

As of October 2008, **no** commercial chambers in the United States are approved for the vacuum fumigation of imported commodities. If vacuum treatment is required as a condition of entry, the consignment **must** be destroyed, reexported, or returned to country of origin.

T203-a-3 Seeds Not Specifically Listed in the T203 Schedules

Pest: External feeders

Treatment: T203-a-3 MB (“Q” label only) tarpaulin

The yellow color of the treatment indicates that the authority to conduct the treatment comes from an emergency action required by PPQ in order to mitigate the pest risk. The emergency action is an interim measure and is pending final regulatory approval.

Temperature (°F)	Dosage Rate (lbs./1000 ft ³)	Minimum Concentration Readings (ounces) At (x) hours:							
		0.5	2	4	5	6	7	8	10
80-96	2.5	30	20	20	15	—	—	—	—
70-79	3.0	36	24	24	18	—	—	—	—
60-69	3.0	36	24	24	—	—	17	—	—
50-59	3.0	36	24	24	—	17	—	17	—
40-49	3.0	36	24	24	—	17	—	17	17

NOTICE

The commodity must not exceed 30 percent of the entire tarped enclosure. Refer to [Fumigants—Methyl Bromide—Tarpaulin Fumigation](#) for instructions on calculating the enclosure size. Do not add moisture when fumigating dry seeds. Normally, dry seed shipments arriving in wet or damp conditions may be injured.

T203-o-1 Seeds of *Casuarina*

Pest: *Bootanomyia* spp. (in *Casuarina*)

Treatment: T203-o-1 MB (“Q” label only) in 26” vacuum

Temperature (°F)	Dosage Rate (lb/1,000 ft ³)	Exposure Period (hours)
70 and above	3.5	6

T203-j Seeds of *Hevea brasiliensis* (Rubber Tree)

Pest: Seed-boring insects

Treatment: T203-j MB (“Q” label only) at NAP

Temperature (°F)	Dosage Rate (lb/1,000 ft ³)	Exposure Period (hours)
80-96	2.5	2
70-79	3.0	2
60-69	3.0	2.5

T203-j-1 Seeds of *Hevea brasiliensis* (Rubber Tree)

Pest: Seed-boring insects

Treatment: T203-j-1 MB (“Q” label only) tarpaulin

The yellow color of the treatment indicates that the authority to conduct the treatment comes from an emergency action required by PPQ in order to mitigate the pest risk. The emergency action is an interim measure and is pending final regulatory approval.

Temperature (°F)	Dosage Rate (lbs./1000 ft ³)	Minimum Concentration Readings (ounces) At (x) hours:			
		0.5	2	4	6
80-96	2.5	30	20	20	—
70-79	3.0	36	24	24	
60-69	3.0	36	24	24	17

NOTICE

The commodity must not exceed 30 percent of the entire tarpaulin enclosure. Refer to [Fumigants—Methyl Bromide—Tarpaulin Fumigation](#) for instructions on calculating the enclosure size. Do not add moisture when fumigating of dry seeds. Normally, dry seed shipments arriving in wet or damp conditions may be injured.

T203-o-3 Seeds of Leguminosae (Fabaceae)

Pest: *Bruchophagus* spp., *Eurytoma* spp.

Treatment: T203-o-3 MB (“Q” label only) in 26” vacuum

Temperature (°F)	Dosage Rate (lb/1,000 ft ³)	Exposure Period (hours)
70 and above	4.0	4

T203-c Seeds of Leguminosae (Fabaceae)

Pest: *Caryedon* spp.

Treatment: T203-c MB (“Q” label only) at NAP—chamber

Temperature (°F)	Dosage Rate (lb/1,000 ft ³)	Exposure Period (hours)
50 and above	2.0	24

T203-o-4-1 Seeds of Leguminosae (Fabaceae)

Pest: *Caryedon* spp. (in or with, etc.)

Treatment: T203-o-4-1 MB (“Q” label only) in 26” vacuum

Temperature (°F)	Dosage Rate (lb/1,000 ft ³)	Exposure Period (hours)
50 and above	2.0	24

T203-o-4-2 Seeds of Leguminosae (Fabaceae)

Pest: *Caryedon* spp. (in or with, etc.)

Treatment: T203-o-4-2 MB (“Q” label only) in 26” vacuum

Temperature (°F)	Dosage Rate (lb/1,000 ft ³)	Exposure Period (hours)
70 and above	3.5	3

Fumigation may render the seeds sterile.

T203-d-1 Seeds of Leguminosae (Fabaceae), excluding *Vicia faba*

Pest: Bruchidae (seed beetles) excluding the beetles of *Caryedon* spp.

Treatment: T203-d-1 MB at NAP—tarpaulin or chamber

Temperature (°F)	Dosage Rate (lb/1,000 ft ³)	Minimum Concentration Readings (ounces) At:					
		0.5 hr	2 hrs	2.5 hrs	3 hrs	3.5 hrs	4 hrs
70 and above	3.0	38	–	24	–	–	–
60-69	3.0	38	29	–	24	–	–
50-59	3.0	38	29	–	–	24	–
40-49	3.0	38	29	–	–	–	24

T203-o-5 Seeds of *Lonicera* and Other Seeds

Pest: *Rhagoletis cerasi* (European cherry fruit fly) pupae (Diptera: Tephritidae)

Treatment: T203-o-5 MB (“Q” label only) at NAP

Temperature (°F)	Dosage Rate (lb/1,000 ft ³)	Exposure Period (hours)
70 and above	4.0	8

Fumigation may render the seeds sterile.

T203-p Seeds of *Citrus* (Rutaceae Family)

Pest: Citrus canker (*Xanthomonas citri*)

Treatment: T203-p Hot water plus chemical dip

1. Wash the seed to remove the pulp.
2. Immerse the seed in water heated to 125 °F (51.6 °C) or higher for 10 minutes.
3. Then, immerse the seed in a solution containing 0.525% (5,250 parts per million) sodium hypochlorite for at least 2 minutes.

Regulatory Authority

Changes to sodium hypochlorite concentration and pH are effective immediately under authorization of 7 CFR 305.3((b)(1)(iv)) and are subject to change pending notice and comment. (October 2020)

See [Sodium Hypochlorite \(Bleach\) Treatments](#) on page 2-13-5 for dilution tables and pH adjustment directions. In general, adjust the pH to 5.5 to 7.0

using acetic acid (white vinegar) under a fume hood or in a well-ventilated area, and mix the following dilutions:

- ◆ Using 8.25%, 8.3%, 8.5%, or 8.6% sodium hypochlorite formulations, mix 1 part in 15 parts of water.
4. Drain, dry, and repack near original moisture content.

The use site **must** be listed on the label. To minimize corrosion of surfaces in contact with bleach, thoroughly wash down all work areas.

T203-o-2 Seeds of *Umbelliferae*

Pest: *Systole* spp. (in *Umbelliferae*)

Treatment: T203-o-2 MB (“Q” label only) in 26” vacuum

Temperature (°F)	Dosage Rate (lb/1,000 ft ³)	Exposure Period (hours)
80-86	2.5	3.5
70-79	3.0	3.5
60-69	3.0	4
50-59	3.0	4.5
40-49	3.0	5

T203-c-1 Seeds of *Vicia* spp. (Vetch Seeds) Including Seeds of *Vicia faba*

Pest: Bruchidae (seed beetles)

Treatment: T203-c-1 MB (“Q” label only) at NAP tarpaulin or chamber

Temperature (°F)	Dosage rate (lb/1,000 ft ³)	Minimum Concentration Readings (ounces) At:					
		0.5 hr	2 hrs	11 hrs	12 hrs	13 hrs	14 hrs
70 and above	3.5	46	28	27	–	–	–
60-69	3.5	46	28	–	27	–	–
50-59	3.5	46	28	–	–	27	–
40-49	3.5	46	28	–	–	–	27

T203-d-2 Seeds of *Vicia* spp. (Vetch Seeds) Including Seeds of *Vicia faba*

Pest: Bruchidae (seed beetles)

Treatment: T203-d-2 MB (“Q” label only) in 26” vacuum

Temperature (°F)	Dosage Rate (lb/1,000 ft ³)	Exposure Period (hours)	
		<i>Vicia faba</i>	All Others
70-96	3.0	3.5	2.5
60-69	3.0	4	3
50-59	3.0	4.5	3.5
40-49	3.0	5	4

NOTICE

Seed consignments arriving wet or damp may be injured.

T203-n Seeds with Infested Pulp

Pest: Fruit flies and other pulp-infesting insects

Treatment: T203-n Depulping

1. Place seed in wire basket.
2. Immerse in water at 118-125 °F for 25 minutes.
3. Remove pulp from seed under running tap water.

NOTICE

This treatment is effective only for fruit flies, as well as some other pulp infesting insects. Fumigation may also be required for seed weevils and other internal and external feeding insects.

Treatment Schedules

T300 - Schedules for Miscellaneous Plant Products

Contents

T301-a—Cotton and Cotton Products (Pectinophora spp.)	5-4-2
T302—Grains and Seeds Not Intended for Propagation	5-4-9
T303—Rice	5-4-16
T304—Alpha (alfa) Grass and Handicrafts (Stipa tenacissima, Ampelodesmos mauritanicus)	5-4-19
T305—Cut Flowers and Greenery	5-4-20
T306—Bags and Bagging Material, Covers	5-4-22
T307—Khapra Beetle Infested Material	5-4-25
T308—Tobacco	5-4-26
T309—Broomcorn and Broomcorn Articles	5-4-30
T310—Tick-Infested Materials (Nonfood)	5-4-32
T311—Hay, Baled	5-4-33
T312—Oak Logs and Lumber	5-4-34
T313—Christmas Trees	5-4-44
T314—Logs and Firewood	5-4-46

NOTICE

Exposure period may be extended for any commodity which **cannot** be used for food or propagation. This extension is only a matter of convenience for the importer and is intended only for the purpose of reducing treatment costs. The request for extension **must** come from the importer or an authorized representative and should be confirmed in writing. A letter is **not** required for each treatment. A single blanket request is acceptable and renewed each year, as required.

During the extended exposure period, the concentrations **must** remain stable and the prescribed minimums be met at the end of the extension. Otherwise, the treatment may be voided and retreatment required. Examples of commodities for which extended exposure periods may be approved include: cotton piece goods, baled cotton, bagging, wood, marble, soil as such, etc. Examples of commodities for which **no** extension may be approved include: cottonseed, grain, tobacco, etc. An extension of exposure period for other purposes is **not** permitted **except** as may be prescribed in various schedules for concentration readings below minimum.

Additional safety precautions, including additional aeration, may be required because of the extended exposure period. The PPQ officer or the commercial fumigator will specify any needed precautions.

T301-a—Cotton and Cotton Products (*Pectinophora* spp.)

T301-a-3 Baled lint or linters

Pest: *Pectinophora* spp.

Treatment: T301-a-3—MB (“Q” label only) at NAP—tarpaulin

Temperature (°F)	Dosage Rate (lb/1,000 ft ³)	Minimum Concentration Readings (ounces) At:			
		0.5 hr	2 hrs	12 hrs	24 hrs
40 and above	7.0	84	60	30	–
	4.0	60	40	–	20

T301-a-7 Cottonseed (samples and bulk)

Pest: *Pectinophora* spp.

Treatment: T301-a-7—Acid delinting and heat treatment (alternative treatment)

Cottonseed delinting is primarily intended for the elimination of surface-borne disease organisms. It is also effective against insects. To be completely effective against insects, this treatment **must** be carried out at approximately 145 °F (by the application of sufficient heat to the seed, or acid, or both), or by raising the temperature of the delinted seed during the subsequent drying process to 145 °F for a period of **not** less than 45 seconds or at least 140 °F for a period of **not** less than 8 minutes.

T301-b—Cotton and Cotton Products (Khapra Beetle)

T301-b-1-1 Baled lint, linters, waste, piece goods, gin trash

Pest: *Trogoderma granarium* (khapra beetle)

Treatment: T301-b-1-1—MB (“Q” label only) at NAP —tarpaulin

Temperature (°F)	Dosage Rate (lb/1,000 ft ³)	Minimum Concentration Readings (ounces) At:		
		0.5 hr	2 hrs	24 hrs ¹
60 and above	8.0	96	64	35
40-59	11.0	132	88	50

- In addition to the space concentration readings, you **must** take a commodity concentration reading. The minimum concentration reading for commodity reading is as follows: For 60 °F or above—25 oz.; for 40-59 °F—30 oz.

NOTICE

Load limit is 50 percent of chamber volume. Concentration readings may be omitted for chamber fumigations.

T301-b-1-2 Baled lint, linters, waste, piece goods, gin trash

Pest: *Trogoderma granarium* (khapra beetle)

Treatment: T301-b-1-2—MB (“Q” label only) in 26” vacuum chamber

Temperature (°F)	Dosage Rate (lb/1,000 ft ³)	Exposure Period (hours)
60 and above	8.0	3
40-59	9.0	3

NOTICE

Items known to be sorptive or items whose sorptive properties are unknown are **not** to be fumigated in chambers at NAP unless gas readings are taken.

T301-b-2 Cottonseed, cottonseed products, or samples

Pest: *Trogoderma granarium* (khapra beetle)

Treatment: T301-b-2—MB (“Q” label only) at NAP—tarpaulin

Temperature (°F)	Dosage Rate (lb/1,000 ft ³)	Minimum Concentration Readings (ounces) At:		
		0.5 hr	2 hrs	12 hrs
90 and above	2.5	30	20	15
80-89	3.5	42	30	20

The sorptive rates of commodities vary. When a commodity is suspected or known to be sorptive, take more gas readings than normal. See [Adding Gas and Extending Exposure Period to Commodities that are Fumigated Using Treatment Schedules Other Than T101-a-1 or Equivalent \(may include perishables\)](#) on page 2-4-33 for information on adding fumigant.

When both woodborers and khapra beetles are involved, use [T404-d Wood Products Including Containers](#) on page 5-5-24.

T301-b-3 Cottonseed meal (not for food or feed)

Pest: *Trogoderma granarium* (khapra beetle)

Treatment: T301-b-3—MB (“Q” label only) at NAP

NOTICE

Cottonseed meal treated under this schedule is **not** to be used for food or feed.

Temperature (°F)	Dosage Rate (lb/1,000 ft ³)	Minimum Concentration Readings (ounces) At:				
		0.5 hr	2 hrs	24 ¹ hrs	28 ² hrs	32 ² hrs
90 and above	4.0	48	32	25	–	–
80-89	6.0	72	48	30	–	–
70-79	8.0	96	64	35	–	–

- 1 In addition to the space concentration readings, you **must** take a commodity concentration reading. The minimum concentration reading for commodity reading is as follows:
For 90-96 °F—10 oz; for 80-89 °F—15 oz; and for 70-79 °F—20 oz.
- 2 Readings at 28 and 32 hours are optional.

T301-c Cotton and cotton products

Pest: *Globodera rostochiensis* (golden nematode)

Treatment: T301-c—MB (“Q” label) at NAP—chamber

Temperature (°F)	Dosage Rate (lb/1,000 ft ³)	Exposure Period (hours)
40 and above	8.0	16
	10.5	12

T301-d-1-1 Cotton and cotton products

Pest: *Anthonomus grandis* (boll weevil)

Treatment: T301-d-1-1—MB (“Q” label only) at NAP—tarpaulin

Temperature (°F)	Dosage Rate (lb/1,000 ft ³)	Minimum Concentration Readings (ounces) At:				
		0.5 hr	2 hrs	3 hrs	4 hrs	8 hrs
90 and above	2.5	30	20	–	–	–
80-89	3.0	36	28	–	–	–
70-79	4.0	48	36	–	–	–
60-69	4.0	50	–	34	–	–
55-59	5.0	64	–	48	–	–
50-54	5.5	70	–	–	50	–
40-49	6.0	80	–	–	54	40

T301-d-1-2 Cotton and cotton products

Pest: *Anthonomus grandis* (boll weevil)

Treatment: T301-d-1-2—Phosphine at NAP—tarpaulin or chamber

Temperature (°F)	Dosage Rate (g/1,000 ft ³)	Minimum Concentration Readings (ppm) at 72 Hours:
50 and above	36 ¹	225 ²

1 36 g/1,000 ft³ (28.3 m³) is equivalent to 1.27 g/m³

2 An average reading with no reading less than 50 ppm

NOTICE

Refer to [Table 5-4-5](#) for data on amount of phosphine liberated by various products.

Refer to [Equipment](#) on page [8-1-1](#) for a description of the MityVac pump and the PortaSens phosphine detector.

Treatment Schedules T300 - Schedules for Miscellaneous Plant Products

T301-a-1-1 Lint, linters, cottonseed meal and hulls, gin trash, waste, or other baled or bulk commodities (except samples)

T301-a-1-1 Lint, linters, cottonseed meal and hulls, gin trash, waste, or other baled or bulk commodities (except samples)

Pest: *Pectinophora* spp.

Treatment: T301-a-1-1—MB (“Q” label only) at NAP—chamber

Temperature (°F)	Dosage Rate (lb/1,000 ft ³) for:		Exposure Period (hours)
	Bulk consignments	Other than bulk consignments	
60 and above	6.0	6	12
	4.0	3	24
40-59	7.0	7	12
	5.0	4	24

T301-a-1-2 Lint, linters, cottonseed meal and hulls, gin trash, waste, or other baled or bulk commodities (except samples)

Pest: *Pectinophora* spp.

Treatment: T301-a-1-2—MB (“Q” label only) in 26” vacuum—chamber

Temperature (°F)	Dosage Rate (lb/1,000 ft ³)	Exposure Period (hours)
60 and above	8.0	3
40-59	9.0	3

NOTICE

For propagative seed cotton, refer to [T203-f-1 Cottonseed—Bagged, Packaged, or in Bulk](#) on page 5-3-34 through [T203-f-4 Cottonseed—Bagged, Packaged, or in Bulk](#) on page 5-3-36.

T301-a-6 Lint, linters, and cottonseed (bulk, sacked, or packaged cottonseed, lint or linters, cottonseed hulls, gin trash, and

T301-a-6 Lint, linters, and cottonseed (bulk, sacked, or packaged cottonseed, lint or linters, cottonseed hulls, gin trash, and all other baled or bulk cotton commodities)

Pest: *Pectinophora* spp.

Treatment: T301-a-6—Phosphine at NAP

Temperature (°F)	Dosage Rate (g/1,000 ft ³)	Minimum Concentration Readings (ppm) at:	
		72 hrs	120 hrs
50 and above	60 ¹	225 ²	50 ³

1 60 g/1,000 ft³ (28.3 m³) is equivalent to 2.1 g/m³

2 An average reading with no reading less than 50 ppm

3 An average of 50 ppm or more

Aerate commodity 24 hours and/or make appropriate tests for presence of gas.

NOTICE

Refer to [Table 5-4-5](#) for data on amount of phosphine liberated by various products.

Refer to [Equipment](#) on page 8-1-1 for a description of the MityVac pump and the PortaSens phosphine detector.

T301-a-2 Lint (except baled lint or linters), cottonseed hulls and meal, gin trash, waste, or other baled or bulk commodities (excluding samples)

Pest: *Pectinophora* spp.

Treatment: T301-a-2—MB (“Q” label only) at NAP—tarpaulin

Temperature (°F)	Dosage Rate (lb/1,000 ft ³)	Minimum Concentration Readings (ounces) At:			
		0.5 hr	2 hrs	12 hrs	24 hrs
40 and above	7.0	84	60	30	–
	5.0	60	40	–	20

T301-a-4 Packaged cottonseed

Pest: *Pectinophora* spp.

Treatment: T301-a-4—MB (“Q” label only) at NAP—tarpaulin

Temperature (°F)	Dosage Rate (lb/1,000 ft ³)	Minimum Concentration Readings (ounces) At:			
		0.5 hr	2 hrs	12 hrs	24 hrs
40 and above	7.0	84	60	30	–
	5.0	60	40	–	20

T301-a-5-1 Samples of cotton and cotton products

Pest: *Pectinophora* spp.

Treatment: T301-a-5-1—MB at NAP—chamber

Temperature (°F)	Dosage Rate (lb/1,000 ft ³)	Exposure Period (hours)
40 and above	3.0	24

T301-a-5-2 Samples of cotton and cotton products

Pest: *Pectinophora* spp.

Treatment: T301-a-5-2—MB in 26” vacuum—chamber

Temperature (°F)	Dosage Rate (lb/1,000 ft ³)	Exposure Period (hours)
40 and above	4.0	2

T301-e Cottonseed for food or feed

Pest: *Fusarium oxysporum* f. sp. *vasinfectum* strains VCG 01111 and VCG 01112

Treatment: 301-e—MB at NAP—tarpaulin

Temperature (°F)	Dosage Rate	Minimum Concentration Readings (ounces) At:						
		2 hrs	4 hrs	6 hrs	12 hrs	24 hrs	36 hrs	48 hrs
40 and above	7.0	60	50	50	35	20	–	–
	5.0	20	–	20	20	15	15	15

T302—Grains and Seeds Not Intended for Propagation

If grain and seeds are for propagation, use appropriate treatment in T203 schedules.

T302-g-1 Acorns not intended for propagation

Pest: *Cydia splendana* (nut fruit tortrix) and *Curculio* spp. (weevils)

Treatment: T302-g-1—MB at NAP—tarpaulin, chamber, or van container

Temperature (°F)	Dosage Rate (lb/1,000 ft ³)	Minimum Concentration Readings (ounces) At:					
		0.5 hr	2 hrs	3 hrs	4 hrs	5 hrs	6 hrs
90-95	4.0	58	32	34	—	—	—
80-89	4.0	58	32	—	34	—	—
70-79	5.0	72	40	—	42	—	—
60-69	5.0	72	40	—	—	40	—
50-59	6.0	85	48	—	—	50	—
40-49	6.0	85	48	—	—	—	48

T302-g-2 Acorns not intended for propagation

Pest: *Cydia splendana* (nut fruit tortrix) and *Curculio* spp. (weevils)

Treatment: T302-g-2—MB in 26" vacuum—chamber

Temperature (°F)	Dosage Rate (lb/1,000 ft ³)	Exposure Period (hours)
80-96	3.0	2
70-79	4.0	2
60-69	4.0	3
50-59	4.0	4
40-49	4.0	5

T302-a-1-1 Ear corn

Pest: Borers

Treatment: T302-a-1-1—MB at NAP—chamber only

Temperature (°F)	Dosage Rate (lb/1,000 ft ³)	Exposure Period (hours)
70 and above	2.0	6

T302-a-1-2 Ear corn

Pest: Borers

Treatment: T302-a-1-2—Dry heat

168 °F minimum air temperature for **not** less than 2 hours; ears spread in single layers on slats or wire shelves.

T302-c—Grains and seeds not intended for propagation, and plant gums

T302-c-1 Grains and seeds not intended for propagation, and plant gums¹

Pest: *Trogoderma granarium* (khapra beetle)

Treatment: T302-c-1—MB (“Q” label only) at NAP—tarpaulin

Temperature (°F)	Dosage Rate (lb/1,000 ft ³)	Minimum Concentration Readings (ounces) At:		
		0.5 hr	2 hrs	12 hrs
90 and above	2.5	30	20	15
80-89	3.5	42	30	20
70-79	4.5	54	40	25
60-69	6.0	72	50	30
50-59	7.5	90	60	35
40-49	9.0	108	70	40

The following commodities are considered as “grains and seeds not for propagation” and are on the MB labels at the rates in the bulleted list:

- ◆ 40 °F and above: barley, corn, oats, popcorn, processed food and grains, rice, rye, sorghum (milo), wheat
- ◆ 80 °F and above: dried beans and peas, dried faba beans, peanuts and tree nuts (almonds, Brazil nuts, bushnuts, butternuts, cashews, filberts, hickory nuts, macadamia nuts, pecans, pistachios, walnuts)
- ◆ 90 °F and above: seeds of dried herbs and spices (refer to T101-n-2-1-1)

¹ Plant gums are defined as "Any of numerous polysaccharide substances of plant origin that are gelatinous when moist but harden on drying. Plant gums include but are not limited to acacia gum, guar gum, gum arabic, locust gum, and tragacanth gum." [7 CFR 319.75-1]

FIFRA Section 18: 40 °F and above: unprocessed cucurbit seed, coffee bean (green unroasted), and oilseeds (See Appendix F: Crop Group 20 for a list of commodities included in the oilseed group.)

Sorptive rates of commodities vary. When a commodity is known or suspected to be sorptive (see T307—Khapra Beetle Infested Material on page 5-4-25), take more gas readings than normal. Additional fumigant is added as prescribed in Adding Gas and Extending Exposure Period to Commodities that are Fumigated Using Treatment Schedules Other Than T101-a-1 or Equivalent (may include perishables) on page 2-4-33.

When both woodborers and khapra beetles are involved, use T404-d Wood Products Including Containers on page 5-5-24.

T302-c-2 Grains and seeds not intended for propagation, and plant gums

Pest: *Trogoderma granarium* (khapra beetle)

Treatment: T302-c-2—MB (“Q” label gas) in 26” vacuum—chamber (load limit 75 percent of chamber volume)

The following commodities are considered as “grains and seeds not for propagation” and are on the MB labels at the rates in the bulleted list:

- ◆ 40 °F and above: barley, buckwheat, corn, oats, popcorn, processed food and grains, rice, rye, sorghum (milo), wheat

Temperature (°F)	Dosage Rate (lb/1,000 ft ³)	Exposure Period (hours)
60 and above	8.0	3
40-59	9.0	3

NOTICE

Items known to be sorptive or items whose sorptive properties are unknown are **not** to be fumigated in chambers at NAP unless gas readings are taken.

T302-c-3 Grains and seeds not intended for propagation, and plant gums

Pest: *Trogoderma granarium* (khapra beetle)

Treatment: T302-c-3—MB (“Q” gas only) in NAP—chamber

Temperature (°F)	Dosage Rate (lb/1,000 ft ³)	Exposure Period (hours)
90-96	2.5	12
80-89	3.5	12
70-79	4.5	12
60-69	6.0	12
50-59	10.0	12
40-49	12.0	12

The following commodities are considered as “grains and seeds not for propagation” and are on the MB labels at the rates in the bulleted list:

- ◆ 60 °F and above: barley, buckwheat, corn, oats, popcorn, processed food and grains, rice, rye, sorghum (milo), wheat

Sorptive rates of commodities vary. When a commodity is known or suspected to be sorptive, take more gas readings than normal. Additional fumigant is added as prescribed in [Adding Gas and Extending Exposure Period to Commodities that are Fumigated Using Treatment Schedules Other Than T101-a-1 or Equivalent \(may include perishables\)](#) on page 2-4-33.

NOTICE

Items known to be sorptive or items whose sorptive properties are unknown are **not** to be fumigated in chambers at NAP unless gas readings are taken.

When both woodborers and khapra beetles are involved, use Schedule T404-d

T302-d Grains and seeds not intended for propagation and contaminated with cottonseed

Pest: *Pectinophora* spp.

Treatment: See [T301-a-1-1 Lint, linters, cottonseed meal and hulls, gin trash, waste, or other baled or bulk commodities \(except samples\)](#) on page 5-4-6 or [T301-a-1-2 Lint, linters, cottonseed meal and hulls, gin trash, waste, or other baled or bulk commodities \(except samples\)](#) on page 5-4-6.

NOTICE

Alternate method—screening for removal of cottonseed contamination.

T302-e-1 Grains and seeds not intended for propagation

The following commodities are considered as “grains and seeds not for propagation” and are on the MB labels at the rates in the bulleted list:

- ◆ 40 F and above: barley, corn, oats, popcorn, processed food and grains, rice, rye, sorghum (milo), wheat, dried beans and peas, dried faba beans, peanuts and tree nuts (almonds, Brazil nuts, bushnuts, butternuts, cashews, filberts, hickory nuts, macadamia nuts, pecans, pistachios, walnuts), seeds of dried herbs and spices (refer to T101-n-2-1-1)

FIFRA Section 18:

- ◆ 40 F and above: unprocessed cucurbit seed, coffee bean (green unroasted), and oilseeds (See Appendix F: Crop Group 20 for a list of commodities included in the oilseed group)

Pest: Insects other than *Trogoderma granarium* (khapra beetle)

Treatment: T302-e-1—MB (“Q” label only) at NAP—chamber

Temperature (°F)	Dosage Rate (lb/1,000 ft ³)	Exposure Period (hours)
80-96	2.5	2.5
70-79	3.0	2.5
60-69	3.0	3
50-59	3.0	3.5
40-49	3.0	4

T302-e-2 Grains and seeds not intended for propagation

Pest: Insects other than *Trogoderma granarium* (khapra beetle)

Treatment: T302-e-2—MB (“Q” label only) at 26” vacuum—chamber

Temperature (°F)	Dosage Rate (lb/1,000 ft ³)	Exposure Period (hours)
80-96	2.5	2.5
70-79	3.0	2.5
60-69	3.0	3
50-59	3.0	3.5
40-49	3.0	4

NOTICE

Load limit is 50 percent of chamber volume. This vacuum treatment is primarily for material that is packed or packaged as to make fumigant penetration questionable.

T302-e-3 Grains and seeds not intended for propagation

Pest: Insects other than *Trogoderma granarium* (khapra beetle)

Treatment: T302-e-3—MB (“Q” label only) tarpaulin or chamber

The yellow color of the treatment indicates that the authority to conduct the treatment comes from an emergency action required by PPQ in order to mitigate the pest risk. The emergency action is an interim measure and is pending final regulatory approval.

Temperature (°F)	Dosage Rate (lbs./1000 ft ³)	Minimum Concentration Readings (ounces) At (x) hours:							
		0.5	2	4	5	6	7	8	10
80-96	2.5	30	20	20	15	—	—	—	—
70-79	3.0	36	24	24	18	—	—	—	—
60-69	3.0	36	24	24	—	—	17	—	—
50-59	3.0	36	24	24	—	17	—	17	—
40-49	3.0	36	24	24	—	17	—	17	17

NOTICE

The commodity must not exceed 30 percent of the entire tarped enclosure. Refer to [Fumigants—Methyl Bromide—Tarpaulin Fumigation](#) for instructions on calculating the enclosure size. Do not add moisture when fumigating dry seeds. Normally, dry seed shipments arriving in wet or damp conditions may be injured.

T302-f Grains and seeds (excluding *Rosmarinus* seed) not intended for propagation

Pest: Snails

Treatment: T302-f—Mechanical separation by screening or hand removal. If **not** feasible, REFUSE ENTRY when snails are of agricultural or public health significance, or treat using appropriate schedule as listed in T403-a.

NOTICE

For *Rosmarinus* seed, use [T203-h Rosmarinus Seeds](#) on page 5-3-38.

T302-b-1-1 Shelled corn

Treatment: T302-b-1-1 *Reserved*

T302-b-1-2 Shelled corn contaminated with cottonseed

Pest: *Pectinophora* spp.

Treatment: T302-b-1-2

See T301-a-1-1 Lint, linters, cottonseed meal and hulls, gin trash, waste, or other baled or bulk commodities (except samples) on page 5-4-6, or T301-a-1-2 Lint, linters, cottonseed meal and hulls, gin trash, waste, or other baled or bulk commodities (except samples) on page 5-4-6.

NOTICE

Shelled corn treated with T302-b-1-2 is **not** to be used for food or feed.

T303—Rice

T303-a (removed)

T303-a-1 through T303-a-3 have been removed. Effective November 1, 2011, APHIS reclassified Panicle Rice Mite (*Steneotarsonemus spinki*, PRM) to a non-quarantine pest.

T303-d-1 Articles made with rice straw

Pest: Fungal diseases of rice or internal feeders

Treatment: T303-d-1—Dry heat at 180-200 °F for 2 hours

T303-d-2 Articles made with rice straw

Pest: Fungal diseases of rice or internal feeders

Treatment: T303-d-2—Steam sterilization

Temperature (°F)	Pressure (lbs)	Exposure Period (minutes)
260	20	15
250	15	20

T303-d-2-1 Articles made with rice straw

Pest: Fungal diseases of rice or internal feeders

Treatment: T303-d-2-1—Steam sterilization, use [T303-b-1 Rice straw and hulls \(tightly packed\) imported for purposes other than approved processing](#) on page [5-4-17](#).

T303-d-2-3 Articles made with rice straw for indoor use only

Pest: Internal feeders

Treatment: T303-d-2-3—MB (“Q” label only) at NAP—tarpaulin or chamber

Temperature (°F)	Dosage Rate (lb/1,000 ft ³)	Minimum Concentration Readings (ounces) At:			
		0.5 hr	2 hrs	4 hrs	24 hrs
60 and above	2.5	30	20	20	15
50-59°	3.0	36	25	24	20
40-49	4.0	48	35	32	25

T303-d-2-2 Articles made with rice straw for indoor use only

Pest: Internal feeders

Treatment: T303-d-2-2—MB (“Q” label only) in 26” vacuum

Temperature (°F)	Dosage Rate (lb/1,000 ft ³)	Exposure Period (hours)
60 and above	2.5	2.5
50-59°	3.5	2.5
40-49	5.0	2.5

T303-b-1 Rice straw and hulls (tightly packed) imported for purposes other than approved processing

Pest: Fungal diseases of rice

Treatment: T303-b-1—Steam sterilization, for closely packed commodity

Introduce the live steam into a 28” vacuum until pressure reaches 10 lbs. and hold for 20 minutes. (Steam sterilization is **not** practical for the treatment of bales having a density greater than 30 lbs. per cubic foot.)

T303-b-2 Rice straw and hulls (loosely packed) imported for purposes other than approved processing

Pest: Fungal diseases of rice

Treatment: T303-b-2—Steam sterilization, for commodity packed as loose masses

Use [T303-b-1 Rice straw and hulls \(tightly packed\) imported for purposes other than approved processing](#) on page [5-4-17](#) or, if **without** initial vacuum, bleed air until steam vapor escapes.

T303-c-1 Rice straw and hulls imported in small lots of 25 lbs. or less

NOTICE

T303-c-1 is suspended until further notice. (01-14-2008)

Pest: Fungal diseases of rice

Treatment: T303-c-1—Dry heat at 212 °F for 1 hour

T304—Alpha (alfa) Grass and Handicrafts (*Stipa tenacissima*, *Ampelodesmos mauritanicus*)

T304-a Alpha (alfa) grass and handicrafts (*Stipa tenacissima*, *Ampelodesmos mauritanicus*)

Pest: Infested with *Harmolita* spp. (jointworms)

Treatment: T304-a—MB at NAP—chamber only

Temperature (°F)	Dosage Rate (lb/1,000 ft ³)	Exposure Period (hours)
60 and above	2.5	32
50-59°	3.5	32
40-49	4.5	32

T304-b Alpha (alfa) grass and handicrafts (*Stipa tenacissima*, *Ampelodesmos mauritanicus*)

Pest: Infested with *Harmolita* spp. (jointworms)

Treatment: T304-b—MB in 26" vacuum

Temperature (°F)	Dosage Rate (lb/1,000 ft ³)	Exposure Period (hours)
60 and above	2.5	2.5
50-59°	3.5	2.5
40-49	5.0	2.5

T305—Cut Flowers and Greenery

T305-a Cut flowers and greenery

NOTICE

The “external pests” controlled by this schedule do **not** include dormant snails. Refer to [T201-o-1 Host Plants of *Omalonyx* spp. and *Succinea* spp. \(Snails\)](#) on page 5-3-12 or [T201-p Plant Material Not Tolerant to Fumigation](#) on page 5-3-20.

Pest: External feeders, leaf miners¹, hitchhikers, surface pests, and slugs²

Treatment: T305-a—MB (“Q” label only) at NAP—tarpaulin or chamber

Temperature (°F)	Dosage Rate (lb/1,000 ft ³)	Minimum Concentration Readings (ounces) At:	
		0.5 hr	2 hrs
80-89	1.5	19	12
70-79	2.0	24	16
60-69	2.5	30	20
50-59	3.0	36	24
40-49	3.5	41	27
40-49 ¹	4	48	38

1 If treating for leaf miners at 40-49 °F, use the dosage rate of 4 lbs/1,000 ft³.

2 Quarantine-significant slugs of the families Agriolimacidae, Arionidae, Limacidae, Milacidae, Philomycidae, and Veronicellidae, including the following genera: *Agriolimax*, *Arion*, *Colosius*, *Deroceras*, *Diplosolenodes*, *Leidyula*, *Limax*, *Meghimatium*, *Milax*, *Pallifera*, *Pseudoveronicella*, *Sarasinula*, *Semperula*, *Vaginulus*, *Veroniella*. **Treat slugs at 60 °F (2.5 lbs.) or above.**

T305-b Cut flowers and greenery

Pest: Borers or soft scales

Treatment: T305-b—MB (“Q” label only) in 15” vacuum

NOTICE

Vacuum fumigation requires prior consent of the importer. If consent is denied, refuse entry unless T305-a plus hand removal of these pests is feasible. Vacuum fumigation is **not** required for soft scales known to be widely distributed in the U.S.

Temperature (°F)	Dosage Rate (lb/1,000 ft ³)	Exposure Period (hours)
80-90	2.5	2
70-79	3.0	2
60-69	3.0	2.5
50-59	3.0	3
40-49	3.0	3.5

T305-c Cut flowers and greenery

Pest: Mealybugs

Treatment: T305-c—MB (“Q” label only) at NAP—tarpaulin or chamber

Temperature (°F)	Dosage Rate (lb/1,000 ft ³)	Minimum Concentration Readings (ounces) At:	
		0.5 hr	2 hrs
80 and above	2.5	32	24
70-79	3.0	38	29
60-69	4.0	48	38

T306—Bags and Bagging Material, Covers

T306-a Bags and bagging material or covers used to contain root crops

Pest: *Globodera rostochiensis* (golden nematode)

Treatment: T306-a—MB (“Q” label only) in 26” vacuum

Temperature (°F)	Dosage Rate (lb/1,000 ft ³)	Exposure Period (hours)
40 and above	8.0	16
	10.5	12
	16.0	8

T306-b Bags and bagging material or covers used for cotton only

Pest: *Pectinophora* spp.

Treatment: T306-b—MB at NAP—chamber

Temperature (°F)	Dosage Rate (lb/1,000 ft ³)		Exposure Period (hours)
	Bulk consignments	Other than bulk consignments	
60 and above	6.0	6.0	12
	4.0	3.0	24
40-59	7.0	7.0	12
	5.0	4.0	24

T306-c—Bags and bagging material or covers

T306-c-1 Bags and bagging material or covers

Pest: *Trogoderma granarium* (khapra beetle)

Treatment: T306-c-1—MB (“Q” label only) at NAP

NOTICE

Concentration readings should be obtained within the commodity.
Concentration readings **not** required for chamber fumigations.

Temperature (°F)	Dosage Rate (lb/1,000 ft ³)	Minimum Concentration Readings (ounces) At:				
		0.5 hr	2 hrs	24 ¹ hrs	28 ¹ hrs	32 ¹ hrs
90 and above	4.0	48	32	25	–	–
80-89	6.0	72	48	30	–	–
70-79	8.0	96	64	35	–	–
60-69	12.0	144	96	50	–	–
50-59	12.0	144	96	50	50	–
40-49	12.0	144	96	50	50 ²	50

- 1 In addition to the space concentration readings, you **must** take a commodity concentration reading. The minimum concentration reading for commodity reading is as follows:
For 90-96 °F—10 oz; for 80-89 °F—15 oz; and for 70-79 °F—20 oz.
- 2 Optional

T306-c-2 Bags and bagging material or covers

Pest: *Trogoderma granarium* (khapra beetle)

Treatment: T306-c-2—MB (“Q” label only) in 26” vacuum

Temperature (°F)	Dosage Rate (lb/1,000 ft ³)	Exposure Period (hours)
60 and above	8.0	3
40-59	9.0	3

T306-d-1 Bagging from unroasted coffee beans

Pest: Various

Treatment: T306-d-1—MB (“Q” label only) at NAP

NOTICE

Concentration readings should be obtained within the commodity.
Concentration readings **not** required for chamber fumigations.

Temperature (°F)	Dosage Rate (lb/1,000 ft ³)	Minimum Concentration Readings (ounces) At:				
		0.5 hr	2 hrs	24 ¹ hrs	28 ¹ hrs	32 ¹ hrs
90 and above	4.0	48	32	25	–	–
80-89	6.0	72	48	30	–	–
70-79	8.0	96	64	35	–	–
60-69	12.0	144	96	50	–	–
50-59	12.0	144	96	50	50	–
40-49	12.0	144	96	50	50	50

- 1 In addition to the space concentration readings, you **must** take a commodity concentration reading. The minimum concentration reading for commodity reading is as follows:
For 90-96 °F—10 oz; for 80-89 °F—15 oz; and for 70-79 °F—20 oz.

T306-d-2 Bagging from unroasted coffee beans

Pest: Various

Treatment: T306-d-2—MB (“Q” label only) in 26” vacuum

Temperature (°F)	Dosage Rate (lb/1,000 ft ³)	Exposure Period (hours)
60 and above	8.0	3
40-59	9.0	3

NOTICE

Load limit maximum 75 percent of chamber volume.

T307—Khapra Beetle Infested Material

T307-a Feeds and milled products heated as part of the processing procedure, or other commodities that can be subjected to heat

Pest: Khapra beetle

Treatment: T307-a—Heat treatment

NOTICE

Do **not** use this treatment unless specifically authorized in each case by the Quarantine Policy, Analysis and Support (QPAS) office in Riverdale, MD.

180 °F in any part of a processing procedure or at 150 °F for a total of 7 minutes, the commodity being moved through or manipulated in the heated area in a manner to ensure that all parts meet the time and temperature requirements.

Reference Table for Miscellaneous Products Infested with Khapra beetle

Pest: Khapra beetle

Treatment: Summary of fumigation treatments

Table 5-4-1 Fumigation Treatment Options for Khapra Beetle Infested Material

Bags and bagging	See T306-c—Bags and bagging material or covers on page 5-4-23
Cotton products	See T301-b—Cotton and Cotton Products (Khapra Beetle) on page 5-4-2
Finely ground oily meals	See T306-c—Bags and bagging material or covers on page 5-4-23
Grains and seeds	See T302-c—Grains and seeds not intended for propagation, and plant gums on page 5-4-10
Flour	See T306-c—Bags and bagging material or covers on page 5-4-23
Sorptive materials (See Sorption on page 2-3-10 for a list of sorptive materials)	See T302-c—Grains and seeds not intended for propagation, and plant gums on page 5-4-10
Goatskins, lambskins, sheepskins (skins and hides),	See T416—Goatskins, Lambskins, Sheepskins (Skins and Hides) on page 5-5-61
Other miscellaneous products	See T302-c—Grains and seeds not intended for propagation, and plant gums on page 5-4-10

T308—Tobacco

T308-e Blended strip tobacco

Pest: *Lasioderma serricorne* (cigarette beetle) and *Ephestia elutella* (tobacco moth)

Treatment: T308-e—Vacuum-steam flow method

1. Evacuate the chamber to the wet bulb temperature of 35 °F (0.2 inches Hg. absolute or 29.8 inches Hg. vacuum) to remove air from the tobacco mass and facilitate steam penetration.
2. Introduce steam until 160 °F is reached while maintaining vacuum to evacuate gases pushed ahead of the steam. Hold at 160 °F for 3 minutes to allow the steam to condense within the tobacco mass for the temperature to equilibrate.
3. Re-evacuate to 110 °F.
4. Introduce steam to 135 °F for 3 minutes to allow the steam to condense within the tobacco mass and for the temperature to equilibrate.

T308-c Leaf tobacco

Pest: *Lasioderma serricorne* (cigarette beetle) and *Ephestia elutella* (tobacco moth)

Treatment: T308-c—Vacuum-steam flow process followed by reconditioning

For leaf tobacco—flowing steam at 170 °F for 15 minutes in 23” vacuum, followed by reconditioning of the tobacco to 12 to 13 percent moisture content.

T308-d Stored tobacco

Pest: *Lasioderma serricorne* (cigarette beetle) and *Ephestia elutella* (tobacco moth)

Treatment: T308-d—Kabat® (active ingredient —methoprene) is an insect growth regulator applied at the rate of 0.2 lbs. (3.9 fluid oz.) per 1,000 lbs. of tobacco

Application should be made directly to tobacco immediately prior to compaction in hogsheads. Assure complete coverage by using multi-directional sprays and tumbling. Kabat® may be applied by use of a proportional dilution apparatus or by preparation of a dilute spray solution.

T308-a-1 Tobacco (flue-cured and burley in hogshead and cases; Turkish in bales; cigar filler/binder in cases or bales; and

Follow mixing and application instructions on the label. Zoecon Corporation will be responsible for ensuring that receivers in foreign countries will accept this treatment in lieu of fumigation.

In most cases, indication of Kabat[®] treatment need **not** be shown on the phytosanitary certificate. PPQ prefers that tobacco exporting firms utilize the letterhead certification of treatment rather than relying on the phytosanitary certificate to convey this information to foreign receivers. However, if requested, an additional declaration may be made showing application rates as supplied by the exporter if it has been determined through periodic inspection of a firm’s facilities that application of the protectant is an integral part of the processing procedure.

T308-a-1 Tobacco (flue-cured and burley in hogshead and cases; Turkish in bales; cigar filler/binder in cases or bales; and cigar wrappers in bales)

Pest: *Lasioderma serricorne* (cigarette beetle) and *Ephestia elutella* (tobacco moth)

Treatment: T308-a-1—MB in 28” vacuum

Temperature (°F)	Dosage Rate(lb/1,000 ft ³)	Exposure Period (hours)
70 and above	4.0	4

T308-a-2 Tobacco (flue cured and burley in hogshead and cases; Turkish in bales; cigar filler/binder in cases or bales; and cigar wrappers in bales)

Pest: *Lasioderma serricorne* (cigarette beetle) and *Ephestia elutella* (tobacco moth)

Treatment: T308-a-2—MB at NAP—tarpaulin or chamber

Temperature (°F)	Dosage Rate (lb/1,000 ft ³)	Exposure Period (hours)
70 and above	1.25	72
45-69	2.0	72

Treatment Schedules T300 - Schedules for Miscellaneous Plant Products

T308-b-1 Tobacco (flue cured and burley in hogshead and cases; Turkish in bales; cigar filler/binder in cases or bales; and

T308-b-1 Tobacco (flue cured and burley in hogshead and cases; Turkish in bales; cigar filler/binder in cases or bales; and cigar wrappers in bales)

Pest: *Lasioderma serricorne* (cigarette beetle) and *Ephestia elutella* (tobacco moth)

Treatment: T308-b-1—Phosphine at NAP—tarpaulin or freight containers

Temperature (°F)	Dosage Rate (g/1,000 ft ³)	Minimum Concentration Readings (ppm) at:	
		96 hrs	144 hrs
Greater than 68	33 ¹	200	–
61-68	33 ¹	–	300

1 33 g/1,000 ft³ is equivalent to 1.17 g/m³

The tobacco industry's Sanitation Committee considers "starting time" as the time when the minimum concentration reading is reached. It is recommended that concentration monitoring be done every 6 hours leading up to "starting time," then again at completion (96 or 120 hours later). [Note that this concept differs from the "starting time" in other phosphine fumigation schedules. In those cases, "starting time" starts when the aluminum phosphide or magnesium phosphide are first introduced.]

NOTICE

Take gas concentration readings and temperature readings in the middle of a tightly packed bale. The fumigation does **not** begin until the gas concentration readings reach minimum required levels.

NOTICE

Refer to the [Equipment](#) section of this manual for a discussion of the MityVac hand-operated gas sampling pump and the PortaSens phosphine monitor. See [Table 5-4-5](#) for data on amount of phosphine liberated by various products.

T308-b-2 Tobacco (flue cured and burley in hogshead and cases; Turkish in bales; cigar filler/binder in cases or bales; and cigar wrappers in bales)

Pest: *Lasioderma serricornis* (cigarette beetle) and *Ephesia elutella* (tobacco moth)

Treatment: T308-b-2—Phosphine at NAP—warehouses

Temperature (°F)	Dosage Rate (g/1,000 ft ³)	Minimum Concentration Readings (ppm) at:	
		96 hrs	144 hrs
Greater than 68	20 ¹	200	–
61-68	20 ¹	–	300

1 20 g/1,000 ft³ is equivalent to 0.71 g/m³

The tobacco industry's Sanitation Committee considers "starting time" as the time when the minimum concentration reading is reached. It is recommended that concentration monitoring be done every 6 hours leading up to "starting time," then again at completion (96 or 120 hours later). [Note that this concept differs from the "starting time" in other phosphine fumigation schedules. In those cases, "starting time" starts when the aluminum phosphide or magnesium phosphide are first introduced.]

NOTICE

Take gas concentration readings and temperature readings in the middle of a tightly packed bale. The fumigation does **not** begin until the gas concentration readings reach minimum required levels.

NOTICE

Refer to [Table 5-4-5](#) for data on amount of phosphine liberated by various products.

T309—Broomcorn and Broomcorn Articles

T309-a Broomcorn and broomcorn articles

Pest: *Ostrinia nubilalis* (European corn borers), ticks, and sawflies

Treatment: T309-a—MB in 26” vacuum

Temperature (°F)	Dosage Rate (lb/1,000 ft ³)	Exposure Period (hours) For:	
		Sawflies	Other than sawflies
60 and above	2.5	5	2.5
50-59	3.5	5	2.5
40-49	5.0	5	2.5

T309-b-1 Broomcorn and broomcorn articles

Pest: *Ostrinia nubilalis* (European corn borers), ticks, and sawflies

Treatment: T309-b-1—MB at NAP—chamber

Temperature (°F)	Dosage Rate (lb/1,000 ft ³)	Exposure Period (hours)
60 and above	2.5	16
50-59	3.5	16
40-49	4.5	16

T309-b-2 Broomcorn and broomcorn articles

Pest: *Ostrinia nubilalis* (European corn borers), ticks, and sawflies

Treatment: T309-b-2—MB at NAP—Railroad car, refrigerated container, highway van, tarpaulin

Temperature (°F)	Dosage Rate (lb/1,000 ft ³)	Minimum Concentration Readings (ounces) At:			
		0.5 hr	2 hrs	4 hrs	24 hrs
60 and above	3.0	36	24	20	15
50-59	5.0	60	40	30	20
40-49	7.0	84	56	40	25

T309-c Broomcorn and broomcorn articles

Pest: *Ostrinia nubilalis* (European corn borers), ticks, and sawflies

Treatment: T309-c—Steam sterilization

Introduce live steam into 25” vacuum until pressure reaches 10 psi and 240 °F, then hold for 20 minutes.

T310—Tick-Infested Materials (Nonfood)

NOTICE

Always check the fumigant label for the proper dosage used on the commodity being treated.

T310-a Nonfood materials

Pest: Ticks

Treatment: T310-a—MB (“Q” label only) at NAP

NOTICE

Hold the infested commodity at the treatment temperature range listed in the schedule (or higher) for 48 hours or more prior to treatment.

Temperature (°F)	Dosage Rate (lb/1,000 ft ³)	Minimum Concentration Readings (ounces) At:							
		0.5 hr	2 hrs	3 hrs	4 hrs	5 hrs	7 hrs	8 hrs	16 hrs
90 and above	4.0	55	45	45	—	—	—	—	—
80-89	5.0	65	52	52	—	—	—	—	—
70-79	6.0	75	50	—	50	—	—	—	—
60-69	7.0	88	60	—	—	60	—	—	—
50-59	8.0	100	70	—	—	—	70	—	—
40-49	8.0	100	65	—	—	—	—	65	50

T310-b Nonfood materials

Pest: Ticks

Treatment: T310-b—MB (“Q” label only) in 26” vacuum

NOTICE

Hold the infested commodity at the treatment temperature range listed in the schedule (or higher) for 48 hours or more prior to treatment.

Temperature (°F)	Dosage Rate (lb/1,000 ft ³)	Exposure Period (hours)
80 and above	3.0	2.5
70-79	3.0	3.5
60-69	4.0	4
50-59	5.5	5

T310-c Nonfood materials

Treatment: T310-c (*Vacant*)

T310-d Nonfood materials

Pest: Ticks

Treatment: T310-d—Sulfuryl fluoride at NAP

Temperature (°F)	Dosage Rate (lb/1,000 ft ³)	Minimum Concentration Readings (ounces) At:		
		0.5 hr	2 hrs	24 hrs
70 and above	2.0	25	16	20
50-69	2.5	32	20	24
40-49	3.0	40	24	28

NOTICE

Fumigations below 50 °F to be used only on an emergency basis and specifically authorized by Quarantine Policy, Analysis and Support (QPAS) in Riverdale, MD.

T311—Hay, Baled

T311 Baled hay

Pest: *Mayetiola destructor* (Hessian fly), *Oulema melanopus* (cereal leaf beetle)

Treatment: T311—Phosphine at NAP

Temperature (°F)	Dosage Rate (g/1,000 ft ³)	Minimum Concentration Readings (ppm) at:			
		0.5 hr	2 hrs	24 hrs	168 hrs
50 and above	60	240	425	700	200

Aerate 24 hours or until a level at or below 0.3 ppm is determined.

See [Table 5-4-5](#) for data on amount of phosphine liberated by various products.

T312—Oak Logs and Lumber

There are two alternative treatments for the MB fumigation of Oak logs, T312-a and T312-a-Alternative. Do **not** combine the schedules.

See [Special Procedures for Adding Gas to Oak Logs Using T312 or T312-a-Alternative](#) on page 5-4-36 for the correct actions to take at each gas concentration reading. Refer to [Table 5-4-3](#) and [Table 5-4-4](#) for every reading.

The following is a list of important items to remember when conducting either of these treatments:

- ◆ Take gas concentration readings 30 minutes after adding gas and record the readings in the S&T-TMT electronic 429A and the electronic 429 database.
 - ❖ To access the 429 database, refer to [Commodity Treatment Information System \(CTIS\)](#).
- ◆ Run the fans for 30 minutes and take gas concentration readings whenever additional gas is added.
- ◆ Ensure that the gas concentration readings **do not differ more than 4 ounces** among the sampling lines. If they do, run the fans for 30 more minutes to equalize the gas.
- ◆ Use DriRite® and Ascarite® during the fumigation. Replace the DriRite® when it changes color from blue to pink. Replace the Ascarite® when the granules become hard or moist.
- ◆ Aerate the logs for a minimum of 48 hours. Follow aeration procedures under sections [Aerating Sorptive Commodities in Containers—Indoors and Outdoors](#) on page 2-4-46 and [Aerating Sorptive, Noncontainerized Cargo—Indoors and Outdoors](#) on page 2-4-44.
- ◆ Add additional time onto the end of the fumigation and record the gas concentration reading in the PPQ Form 429A and the electronic 429 database. Explain the reason the treatment was extended in the Remarks section.

NOTICE

The 72 hour reading must be taken even if the fumigation has been extended. Take the 72 hour reading and then take the extra reading as required by [Table 5-4-3](#) or [Table 5-4-4](#).

Refer to [Table 5-4-2](#) for metric equivalents for T312-a.

Table 5-4-2 Metric Equivalents for T312-a

Temperature (°F)	Dosage Rate (lbs/1,000 ft ³)	Temperature (°C)	Dosage Rate g/m ³
40 or above	15.0	4.4 or above	240

T312-a Oak Logs

Pest: Oak wilt disease

Treatment: T312-a—MB (“Q” label only) at NAP

Temperature (°F)	Dosage Rate (lb/1,000 ft ³)	Minimum Concentration Readings (ounces) At: ¹						
		0.5 hr ²	2 hrs ³	12 hrs	24 hrs ⁴	36 hrs	48 hrs	72 hrs
40 and above	15.0	240	240	200	240	160	120	80

- 1 Refer to [Table 5-4-3](#) for adding gas at each reading.
- 2 If the fumigation is conducted in a closed-door container, take the first reading at 1 hour instead of 0.5 hours.
- 3 If the fumigation is conducted in a closed-door container, take the second reading at 2.5 hours instead of 2 hours.
- 4 After 24 hours, add enough fumigant to bring the concentration up to 240 oz.

T312-a-Alternative Oak logs

Pest: Oak wilt disease

Treatment: T312-a-Alternative—MB (“Q” label only) at NAP

Temperature (°F)	Dosage Rate (lb/1,000 ft ³)	Minimum Concentration Readings (ounces) At: ¹				
		0.5 hr ²	2 hrs ³	24 hrs ⁴	48 hrs	72 hrs
40 and above	15.0	240	240	240	140	100

- 1 Refer to [Table 5-4-4](#) for adding gas at each reading.
- 2 If the fumigation is conducted in a closed-door container, take the first reading at 1 hour instead of 0.5 hours.
- 3 If the fumigation is conducted in a closed-door container, take the second reading at 2.5 hours instead of 2 hours.
- 4 After 24 hours, add enough fumigant to bring the concentration up to 240 oz.

Special Procedures for Adding Gas to Oak Logs Using T312 or T312-a-Alternative

There are two alternative treatments for the MB fumigation of oak logs. Refer to [Table 5-4-3](#) and [Table 5-4-4](#) for actions to take during the fumigation of oak logs using T312-a or T312-a-Alternative.

Use the formula in [Figure 5-4-1](#) to calculate the amount of gas to add to the enclosure:

$$1.6 \times \text{number of ounces below minimum} \times \frac{\text{volume in cubic feet}}{1,000 \text{ cubic feet}} \times 1/16 = \text{pounds of gas to add}$$

Figure 5-4-1 Formula for Determining the Amount of Gas to Add

After adding gas, run the fans for 30 minutes and take additional gas concentration readings.

Refer to [Table 5-4-3](#) if using T312-a and [Table 5-4-4](#) if using T312-a-Alternative to determine how much additional time must be added to the fumigation to compensate for the low gas concentrations.

EXAMPLE

The treatment schedule is T312-a-Alternative. The size of the enclosure is 2400 ft³. The required reading at 48 hours **must** be a minimum of 140 ounces. The actual lowest reading is 132 ounces. Calculate the amount of gas to add to the enclosure using the formula:

$$1.6 \times (\text{the number of ounces below } 140) \times (\text{volume in ft}^3)/1,000 \text{ ft}^3$$

ANSWER: 140-132=8

$$1.6 \times 8 \times 2400 = 30,720/1,000 = 30.72 \text{ ounces of gas to add}$$
$$30.72/16 = 1.92 \text{ pounds of gas to add}$$

Determine the amount of time to add by referring to [Table 5-4-4](#). In this example, 1 hour will be added to the total fumigation time.

Take the regularly scheduled reading at 72 hours (the minimum should be 100 ounces).

Take another reading at 73 hours (the minimum should be 100 ounces).

If the minimum is **not** 100 ounces, add more gas and time according to [Table 5-4-4](#).

Instructions for Adding Gas and Time to Schedule T312-a

Do **not** combine Schedules T312-a and T312-a-Alternative. The treatment **must** be aborted if any individual gas concentration reading is 50 percent or more below the minimum required concentration.

Table 5-4-3 Determine Gas Concentration Values and Corrections for Oak Log Fumigations Using Schedule T312-a

0.5 hour ¹	121-239	1. ADD gas, and 2. EXTEND exposure by 0.5 hour
	0-120	ABORT
2 hours ²	160-239	1. ADD gas, and 2. EXTEND exposure by 0.5 hour
	121-159	1. ADD gas, and 2. EXTEND exposure by 1.0 hour
	0-120	ABORT
12 hours	190-199	1. ADD gas, and 2. EXTEND exposure by 0.5 hour
	180-189	1. ADD gas, and 2. EXTEND exposure by 1.0 hour
	170-179	1. ADD gas, and 2. EXTEND exposure by 1.5 hours
	160-169	1. ADD gas, and 2. EXTEND exposure by 2.0 hours
	150-159	1. ADD gas, and 2. EXTEND exposure by 2.5 hours
	140-149	1. ADD gas, and 2. EXTEND exposure by 3.0 hours
	130-139	1. ADD gas, and 2. EXTEND exposure by 3.5 hours
	120-129	1. ADD gas, and 2. EXTEND exposure by 4.0 hours
	110-119	1. ADD gas, and 2. EXTEND exposure by 4.5 hours
	101-109	1. ADD gas, and 2. EXTEND exposure by 5.0 hours
	0-100	ABORT

Table 5-4-3 Determine Gas Concentration Values and Corrections for Oak Log Fumigations Using Schedule T312-a (continued)

24 hours	120-239	1. ADD gas to bring the total concentration to 240 ounces 2. DO NOT ADD TIME
	110-119	1. ADD gas, and 2. EXTEND exposure by 1.0 hour
	100-109	1. ADD gas, and 2. EXTEND exposure by 2.0 hours
	90-99	1. ADD gas, and 2. EXTEND exposure by 3.0 hours
	80-89	1. ADD gas, and 2. EXTEND exposure by 4.0 hours
	70-79	1. ADD gas, and 2. EXTEND exposure by 5.0 hours
	61-69	1. ADD gas, and 2. EXTEND exposure by 6.0 hours
	0-60	ABORT
36 hours	150-159	1. ADD gas, and 2. EXTEND exposure by 1.0 hour
	140-149	1. ADD gas, and 2. EXTEND exposure by 1.5 hours
	130-139	1. ADD gas, and 2. EXTEND exposure by 2.5 hours
	120-129	1. ADD gas, and 2. EXTEND exposure by 3.0 hours
	110-119	1. ADD gas, and 2. EXTEND exposure by 4.0 hours
	100-109	1. ADD gas, and 2. EXTEND exposure by 4.5 hours
	90-99	1. ADD gas, and 2. EXTEND exposure by 5.5 hours
	81-89	1. ADD gas, and 2. EXTEND exposure by 6.0 hours
	0-80	ABORT

Table 5-4-3 Determine Gas Concentration Values and Corrections for Oak Log Fumigations Using Schedule T312-a (continued)

48 hours	110-119	1. ADD gas, and 2. EXTEND exposure by 1.0 hour
	100-109	1. ADD gas, and 2. EXTEND exposure by 2.0 hours
	90-99	1. ADD gas, and 2. EXTEND exposure by 3.0 hours
	80-89	1. ADD gas, and 2. EXTEND exposure by 4.0 hours
	70-79	1. ADD gas, and 2. EXTEND exposure by 5.0 hours
	61-69	1. ADD gas, and 2. EXTEND exposure by 6.0 hours
	0-60	ABORT
72 hours	70-79	1. ADD gas, and 2. EXTEND exposure by 3.0 hours
	60-69	1. ADD gas, and 2. EXTEND exposure by 6.0 hours
	50-59	1. ADD gas, and 2. EXTEND exposure by 9.0 hours
	41-49	1. ADD gas, and 2. EXTEND exposure by 12.0 hours
	0-40	ABORT

- 1 If the fumigation is conducted in a closed-door container, take the first reading at 1 hour instead of 0.5 hours.
- 2 If the fumigation is conducted in a closed-door container, take the second reading at 2.5 hours instead of 2 hours.

NOTICE

If additional time has been added to the treatment, the 72 hour reading AND the extended time reading **MUST** be taken. If the minimum of 80 ounces is **not** met, time and gas **MUST** be added according to this table ([Table 5-4-3](#)).

Instructions for Adding Gas and Time to Schedule T312-a-Alternative

Do **not** combine schedules T312-a and T312-a-Alternative.

Table 5-4-4 Determine Gas Concentration Values and Corrections for Oak Log Fumigations Using Schedule T312-a-Alternative

0.5 hours ¹	121-139	1. ADD gas, and 2. DO NOT EXTEND EXPOSURE
	0-120	ABORT
2 hours ²	160-239	1. ADD gas, and 2. DO NOT EXTEND EXPOSURE
	121-159	1. ADD gas, and 2. EXTEND exposure by 1.0 hour
	0-120	ABORT
24 hours	140-239	1. ADD gas to bring the total concentration to 240 ounces 2. DO NOT ADD TIME
	130-139	1. ADD gas, and 2. EXTEND exposure by 1.0 hour
	120-129	1. ADD gas, and 2. EXTEND exposure by 2.5 hours
	110-119	1. ADD gas, and 2. EXTEND exposure by 4.0 hours
	100-109	1. ADD gas, and 2. EXTEND exposure by 5.5 hours
	90-99	1. ADD gas, and 2. EXTEND exposure by 7.0 hours
	80-89	1. ADD gas, and 2. EXTEND exposure by 8.5 hours
	71-79	1. ADD gas, and 2. EXTEND exposure by 10.0 hours
	0-70	ABORT

Table 5-4-4 Determine Gas Concentration Values and Corrections for Oak Log Fumigations Using Schedule T312-a-Alternative (continued)

48 hours	130-139	1. ADD gas, and 2. EXTEND exposure by 1.0 hour
	120-129	1. ADD gas, and 2. EXTEND exposure by 2.5 hours
	110-119	1. ADD gas, and 2. EXTEND exposure by 4.5 hours
	100-109	1. ADD gas, and 2. EXTEND exposure by 6.0 hours
	90-99	1. ADD gas, and 2. EXTEND exposure by 8.5 hours
	80-89	1. ADD gas, and 2. EXTEND exposure by 9.5 hours
	71-79	1. ADD gas, and 2. EXTEND exposure by 11 hours
	0-70	ABORT
72 hours	90-99	1. ADD gas, and 2. EXTEND exposure by 1.5 hours
	80-89	1. ADD gas, and 2. EXTEND exposure by 4.0 hours
	70-79	1. ADD gas, and 2. EXTEND exposure by 7.5 hours
	60-69	1. ADD gas, and 2. EXTEND exposure by 8.5 hours
	51-59	1. ADD gas, and 2. EXTEND exposure by 11.0 hours
	0-50	ABORT

- 1 If the fumigation is conducted in a closed-door container, take the first reading at 1 hour instead of 0.5 hours.
- 2 If the fumigation is conducted in a closed-door container, take the second reading at 2.5 hours instead of 2 hours.

NOTICE

If additional time has been added to the treatment, the 72 hour reading AND the extended time reading **MUST** be taken. If the minimum of 100 ounces is **not** met, time and gas **MUST** be added according to this table (Table 5-4-4).

T312-b Oak Lumber

Pest: Oak wilt disease

Treatment: T312-b—MB (“Q” label only) at NAP

Temperature (°F)	Dosage Rate (lb/1,000 ft ³)	Minimum Concentration Readings (ounces) At:					
		0.5 hr ¹	2 hrs ²	12 hrs	24 hrs ³	36 hrs	48 hrs
40 and above	15.0	240	160	100	40	120	80

- 1 If the fumigation is conducted in a closed-door container, take the first reading at 1 hour instead of 0.5 hours.
- 2 If the fumigation is conducted in a closed-door container, take the second reading at 2.5 hours instead of 2 hours.
- 3 After 24 hours, add enough fumigant to bring the concentration up to 240 oz.

T313—Christmas Trees

NOTICE

Cut trees at least 2 weeks prior to treatment in order to reduce possible damage by the fumigant to the trees.

T313-a Cut conifer Christmas trees

Pest: *Lymantria dispar* (gypsy moth) egg masses

Treatment: T313-a—MB (“Q” label only) at NAP—tarpaulin or chamber

Temperature (°F)	Dosage Rate (lb/1,000 ft ³)	Minimum Concentration Readings (ounces) At:				
		0.5 hr	2.5 hrs	3 hrs	4 hrs	4.5 hrs
75 and above	1.5	18	12	–	–	–
70-74	2.0	24	16	–	–	–
60-69	2.5	30	–	24	–	–
	3.0	36	24	–	–	–
50-59	3.0	36	–	–	24	–
	4.0	48	32	–	–	–
40-49	3.5	42	–	–	–	28
	5.0	60	40	–	–	–

T313-b Cut pine Christmas trees and pine logs

Pest: *Tomicus piniperda* (pine shoot beetle)

Treatment: T313-b—MB (“Q” label only) at NAP—chamber or tarpaulin

Temperature (°F)	Dosage Rate (lb/1,000 ft ³)	Minimum Concentration Readings (ounces) At:			
		2 hrs	3 hrs	3.5 hrs	4 hrs
60 and above	3.0	43	–	–	36
	4	57	48	–	–
50-59	3.5	50	–	–	42
	4.0	57	–	48	–
40-49	4.0	57	–	–	48

NOTICE

If treating pine Christmas trees for both gypsy moth egg masses and the pine shoot beetle, use [T313-b Cut pine Christmas trees and pine logs](#) on page 5-4-44.

T313-c Cut Christmas trees (Araucariaceae, Cephalotaxaceae, Cupressaceae, Pinaceae, Podocarpaceae, Sciadopityaceae, Taxaceae)

Pest: External feeders, leaf miners, needle miners, sheath miners, hitchhikers, surface pests, and slugs³

Treatment: T313-c—MB (“Q” label only) at NAP—chamber or tarpaulin

The yellow color of this treatment indicates that the authority to conduct the treatment comes from an emergency action required by PPQ in order to mitigate the pest risk. The emergency action is an interim measure and is pending regulatory action. The treatment is subject to change or removal based on public comment (7 CFR 305.3(b)(2)).

Temperature (°F)	Dosage Rate (lb/1,000 ft ³)	Minimum Concentration Readings (ounces) At:	
		0.5 hr	2.5 hr
80 and above	1.5	19	12
70-79	2	24	16
60-69	2.5	30	20
50-59	3	36	24
40-49	4	48	32

³ Quarantine-significant slugs of the families Agriolimacidae, Arionidae, Limacidae, Milacidae, Philomycidae, and Veronicellidae, including the following genera: *Agriolimax*, *Arion*, *Colosius*, *Deroceras*, *Diplosolenodes*, *Leidyula*, *Limax*, *Meghimatium*, *Milax*, *Pallifera*, *Pseudoveronicella*, *Sarasinula*, *Semperula*, *Vaginulus*, *Veronicella*. **Treat slugs at 60 °F (2.5 lbs.) or above.**

T314—Logs and Firewood

These heat treatment procedures may employ steam, hot water, kilns, or any other method that raises the temperature of the center of the log to the minimum required temperature for the time specified. Procedures for obtaining internal log temperature can be found in chapter [Fumigants—Methyl Bromide—Tarpaulin Fumigation](#).

The heat treatment must be performed at an approved facility that maintains a current compliance agreement. The PPQ official will review facility treatment records to ensure the treatment temperature and duration requirements have been met.

Contact USDA-APHIS-PPQ Pest Survey Detection and Exclusion Laboratory at (508) 563-9303 ext. 259 for a list of approved facilities, temperature monitoring equipment, and operational guidelines.

NOTICE

For annual facility certification guidelines, follow the procedures in [Certifying Facilities for the Heat Treatment of Firewood](#) on page 6-9-1.

T314-a Regulated Wood Articles⁴, Including *Fraxinus* (Ash Logs and Firewood) and all Hardwood Firewood From Emerald Ash Borer Quarantine Areas

Pest: *Agrilus planipennis* (emerald ash borer)

Treatment: T314-a—Heat treatment

Unit	Temperature	Time (minutes)
°F	140.0	60
°C	60.0	60

⁴ Regulated articles of *Fraxinus* spp. from Canada include: firewood of all hardwood (non-coniferous) species; nursery stock, green lumber, and other material living, dead, cut, or fallen, including logs, stumps, roots, branches, and composted and uncomposted chips. (7CFR 319.40-5(n)).

T314-b All logs (including firewood) from gypsy moth quarantine areas⁵

Pest: *Lymantria dispar* (gypsy moth egg masses)

Treatment: T314-b—Heat treatment

Unit	Temperature	Time (minutes)
°F	132.8	30
°C	56.0	30

T314-c Regulated wood articles⁶

Pest: Various wood pests

Treatment: T314-c—Heat treatment

Unit	Temperature	Time (minutes)
°F	160.0	75
°C	71.1	75

⁵ If the regulated article originates from areas quarantined for BOTH gypsy moth and emerald ash borer, use T314-a.

⁶ Regulated wood articles are considered to be unprocessed logs; lumber; any whole tree; any cut tree or any portion of a tree **not** solely consisting of leaves, flowers, fruits, buds, or seeds; bark; cork; laths; hog fuel; sawdust; painted raw wood products; wood mulch; wood shavings; pickets; stakes; shingles; solid wood packing materials; humus; compost; and litter. (7CFR 319.40-1)

Amount of Phosphine Liberated by Various Products

Calculate amount of product needed by using the amount of phosphine released as shown in the right column.

Table 5-4-5 Amount of Phosphine Liberated by Various Products

Product	Type	Unit and Weight in Grams	Grams of Phosphine ¹
Degesch Fumi-Cel [®]	MP	1 plate; 117.0	33.0
Degesch Fumi-Strip [®]	MP	16 plates; 1872.0	528.0
Degesch Phostoxin [®]	AP	1 tablet; 3.0	1.0
Degesch Phostoxin [®] Tablet Prepac Rope	AP	1 prepac; 99.0 (strip or rope of 33 tablets)	33.0
Detia	AP	1 tablet; 3.0	1.0
Detia Rotox AP	AP	1 pellet; 0.6	0.2
Detia Gas EX-B	AP	1 bag or sachet; 34.0	11.4
Fumiphos tablets	AP	1 tablet; 3.0	1.0
Fumiphos pellets	AP	1 pellet; 0.6	0.2
Fumiphos bags	AP	1 bag; 34.0	11.0
Fumitoxin [®]	AP	1 tablet; 3.0	1.0
Fumitoxin [®]	AP	1 pellet; 0.6	0.2
Fumitoxin [®]	AP	1 bag; 34.0	11.0
Gastoxin [®]	AP	1 tablet; 3.0	1.0
Gastoxin [®]	AP	1 pellet; 0.6	0.2
"L" Fume	AP	1 pellet; 0.5	0.18
	AP	1 pellet; 0.6	0.22
Phos-Kill	AP	1 tablet; 3.0	1.1
Phos-Kill	AP	1 pellet; 0.6	0.22
Phos-Kill	AP	1 bag; 34.0	12.0

1 Reacts with moisture in the air to yield grams of phosphine.

Treatment Schedules

T400 - Schedules for Miscellaneous Products

Contents

Commodities treated with the schedules in this chapter are **not** to be used for food or feed.

- T401—Railroad Cars (Empty) **5-5-3**
- T402—Containers, Ships, and Surrounding Areas **5-5-4**
- T403—Miscellaneous Cargo (Nonfood, Nonfeed Commodities) **5-5-10**
- T404—Wood Products Including Containers **5-5-18**
- T405—Bags and Bagging Material **5-5-31**
- T406—Golden Nematode Contaminations **5-5-31**
- T407—Mechanical Cotton Pickers and Other Cotton Equipment **5-5-35**
- T408—Soil as Such and Soil Contaminating Durable Commodities **5-5-36**
- T409—Aircraft **5-5-40**
- T410—Tick Infestations **5-5-55**
- T411—Ant Infestations—Nonplant Products **5-5-55**
- T412—Noxious Weed Seeds (Devitalization Treatment) **5-5-56**
- T413—Brassware From Mumbai (Bombay), India **5-5-57**
- T414—Inanimate, Nonfood Articles with Gypsy Moth Egg Masses **5-5-58**
- T415—Garbage and Quarantine Material Interceptions for Destruction
5-5-59
- T416—Goatskins, Lambskins, Sheepskins (Skins and Hides) **5-5-61**

NOTICE

Exposure period may be extended for any commodity which **cannot** be used for food or propagation. This extension is only a matter of convenience for the importer and is intended only for the purpose of reducing treatment costs. The request for extension **must** come from the importer or his authorized representative and should be confirmed in writing. A letter is **not** required for each treatment. A single blanket request should be considered as acceptable and renewed each year, as required.

During the extended exposure period, the concentrations **must** remain stable and the prescribed minimums be met at the end of the extension. Otherwise, the treatment may be voided and retreatment required. Examples of commodities for which extended exposure periods may be approved include: cotton piece goods, baled cotton, bagging, wood, marble, soil as such, etc. Examples of commodities for which **no** extension may be approved include: cottonseed, grain, tobacco, etc. An extension of exposure period for other purposes is **not** permitted **except** as may be prescribed in various schedules for concentration readings below minimum.

Additional safety precautions, including additional aeration, may be required because of the extended exposure period. The PPQ officer or the commercial fumigator will specify any needed precautions.

T401—Railroad Cars (Empty)

T401-a Railroad Cars (Empty)

Pest: *Pectinophora gossypiella* (pink bollworm) and fruit flies

Treatment: T401-a—MB (“Q” label only) at NAP

Temperature (°F)	Dosage Rate (lb/1,000 ft ³)	Exposure Period (hours)
40 and above	4.0	12
	8.0	3

T401-b Railroad Cars (Empty)

Pest: *Trogoderma granarium* (khapra beetle)

Treatment: T401-b—MB (“Q” label only) at NAP—tarpaulin covered car

Temperature (°F)	Dosage Rate (lb/1,000 ft ³)	Minimum Concentration Readings (ounces) At:		
		0.5 hr	2 hrs	12 hrs
90 and above	2.5	30	20	15
80-89	3.5	42	30	20
70-79	4.5	54	40	25
60-69	6.0	72	50	30
50-59	7.5	90	60	35
40-49	9.0	108	70	40

T401-c Railroad Cars (Empty)

Pest: For nematode cysts

Treatment: T401-c—High pressure steam cleaning. The debris and/or runoff from the cleaning procedure **must** be handled in a manner approved by local and port authority guidelines.

T402—Containers, Ships, and Surrounding Areas

⚠ DANGER

These schedules use insecticides that may be toxic to fish, aquatic invertebrates, small mammals, birds, and bees. Do **not** apply directly to water, or to areas where surface water is present or to intertidal areas below the mean high water mark. Do **not** apply where runoff is likely to occur. Do **not** apply these insecticides or allow them to drift to blooming crops or weeds if bees are visiting the treatment area. ALWAYS refer to the labels for specific environmental, physical, and chemical hazards, mixing and application instructions.

Apply these insecticides according to the manufacturer's labels and all state and local restrictions. Direct the spray to areas where the insects congregate, with special attention to corners, cracks, and crevices. Before using any insecticide, verify that it is registered for use in YOUR city, state, or county.

T402-b-3-1 Pest: *Trogoderma granarium* (Khapra Beetle)

Treatment: T402-b-3-1—General surface, perimeter, spot, mist, or crack and crevice treatment

Refer to [Table 5-5-7](#) for a partial site list. Always refer to the manufacturer's label for specific areas of use.

Changes to [Table 5-5-1](#) are effective immediately under authorization of 7 CFR 305.3(b) and are subject to change pending notice and public comment:

- ◆ Add β-Cyfluthrin, Chlorfenapyr, and Cyfluthrin
- ◆ Delete Malathion

Table 5-5-1 T402-b-3-1 Chemical Alternatives

Active Ingredient ¹	Examples of Trade Names and EPA Registration Numbers (list not all-inclusive) ²
β-Cyfluthrin 10,11.8, 20, 24.3, 80% a.i.	Tempo® 1 (#432-1304); Tempo® 10 WP (#432-1305); Tempo® Ultra SC (#432-1363); Tempo® SC Ultra Premise spray (#11556-124); Tempo® Ultra WSP (#432-1377); Tempo® Ultra WP (#432-1304)
Chlorfenapyr 21.45% a.i.	Phantom® Termiticide -Insecticide (#241-392)
Cyfluthrin 6, 20, 24.4% a.i.	Cy-Kick® CS (#499-304); OPTEM® PT 600 ME (#499-304); TC 62 (#499-489); Tempo® 2 (#432-1299); Tempo® 20 WSP (#432-1301); Tempo® 20 WP (#432-1302)
Deltamethrin 4.75% a.i.	Suspend SC, K-Othrine® SC (#432-763) D-FENSE SC, Delta SC (#53883-276)

1 Apply at the highest rate allowed for the site on the label. (active ingredient = a.i.)

2 No endorsement is intended for the particular items listed and no discrimination is intended toward those products or companies that may **not** be listed. Use other formulations as long as the application method, site, and rate are listed on the label.

T402-b-3-2 Deleted

T402-d Pests: Miscellaneous Hitchhiking Insects (E.g., Crickets, Scarab Beetles, Ants, Africanized Honeybee Swarms, Spotted Lanternfly)

Treatment: T402-d—General surface, perimeter, spot, mist, or crack and crevice treatment

NOTICE

Use β -Cyfluthrin for spotted lanternfly (*Lycorma delicatula*) adults and nymphs, **not** egg masses.

Refer to [Table 5-5-7](#) for a partial site list. Always refer to the manufacturer's label for specific areas of use.

Table 5-5-2 T402-d Chemical Alternatives

Active Ingredient ¹	Examples of Trade Names and EPA Registration Numbers (list not all-inclusive) ²
Chlorpyrifos	Whitmire PT [®] , Duraguard ME (#499-367)
β -Cyfluthrin 11.8% a.i.	Tempo Ultra [®] SC (#432-1363)
Cyfluthrin 6% a.i.	Cy-Kick [®] CS, OPTEM [®] (#499-304)
Cypermethrin 25.3% a.i.	Demon [®] EC (#100-1004)
Deltamethrin 4.75% a.i.	Suspend SC, K-Othrine [®] (#432-763) D-FENSE [™] SC, Delta SC (#53883-276)
Lambda-Cyhalothrin 9.7% a.i.	Cyonara [™] 9.7, Cyzmic [™] CS, Demand [®] CS (#100-1066)
Malathion 57% EC	Clean Crop Malathion (#34704-108)

1 Apply at the highest rate allowed for the site on the label. (active ingredient = a.i.)

2 **No** endorsement is intended for the particular items listed and **no** discrimination is intended toward those products or companies that may **not** be listed. Use other formulations as long as the application method, site, and rate are listed on the label.

T402-c Empty Holds (Precautionary Treatment for Grain Exports)

Pest: **Without** khapra beetle infestation

Treatment: T402-c—MB at NAP

Treatment Schedules T400 - Schedules for Miscellaneous Products

T402-a-1 Ship Holds and Any Nonplant Cargo Material Within Holds

Temperature (°F)	Dosage Rate (lb/1,000 ft ³)	Exposure Period (hours)
60 and above	1.0	10
50-59	1.0	12
40-49	1.5	12

NOTICE

Operate fans during gas introduction and for 30 minutes thereafter. During exposure period, operate fans for 30 minutes every 3 hours.

NOTICE

If khapra beetle is present, see [T401-b Railroad Cars \(Empty\)](#) on page 5-5-3.

T402-a-1 Ship Holds and Any Nonplant Cargo Material Within Holds

Pest: Quarantine-significant snails of the family Achatinidea, including the following genera: *Achatina*, *Archachatina*, *Lignus*, *Limicolaria*, *Lissachatina*

NOTICE

Do **not** use this treatment against snails in the subfamily Subulininae.

Treatment: T402-a-1—MB (“Q” label only) at NAP

Temperature (°F)	Dosage Rate (lb/1,000 ft ³)	Minimum Concentration Readings (ounces) At:		
		0.5 hr	2 hrs	24 hrs
55 and above	8.0	96	65	35

T402-a-2 Ship Holds and Any Nonplant Cargo Material Within Holds

Pest: Quarantine-significant snails of the family Geomitridae, Hygromiidae, including the following genera: *Backeljaia*, *Candidula*, *Cernuella*, *Cochlicella*, *Helicella*, *Helicopsis*, *Hygromia*, *Monacha*, *Monachoides*, *Platytheba*, *Pseudotruchia*, *Trochoidea*, *Xerolenta*, *Xeropicta*, *Xeroplexa*, *Xerosecta*, *Xerotricha*

Treatment: T402-a-2—MB (“Q” label only) at NAP

Temperature (°F)	Dosage Rate (lb/1,000 ft ³)	Minimum Concentration Readings (ounces) At:				
		0.5 hr	2 hrs	24 hrs	48 hrs	72 hrs
55 and above	8.0	95	64	62	60	40

T402-a-3 Ship Holds and Any Nonplant Cargo Material Within Holds

Pest: Quarantine-significant snails of the families Helicidae and Succineidae, including the following genera: *Arianta*, *Cepaea*, *Cornu*, *Helix*, *Massylaea*, *Omalonyx*, *Otala*, *Succinea*, *Theba*

Treatment: T402-a-3—MB (“Q” label only) at NAP

Temperature (°F)	Dosage Rate (lb/1,000 ft ³)	Minimum Concentration Readings (ounces) At:					
		0.5 hr	2 hrs	10 hrs	12 hrs	16 hrs	24 hrs
80 and above	6.0	70	48	40	–	–	–
55-79	6.0	70	48	–	–	40	–
40-54	8.0	96	64	–	–	–	39

T402-b-1 Ship Holds and Storerooms That Do Not Contain Finely Milled Products, Such as Flour or Appreciable Quantities of Tightly Packed Cargo, Such as Baled Materials

Pest: *Trogoderma granarium* (khapra beetle)

Treatment: T402-b-1—MB (“Q” label only) at NAP—tarpaulin covered car

Temperature (°F)	Dosage Rate (lb/1,000 ft ³)	Minimum Concentration Readings (ounces) At:		
		0.5 hr	2 hrs	12 hrs
90 and above	2.5	30	20	15
80-89	3.5	42	30	20
70-79	4.5	54	40	25
60-69	6.0	72	50	30
50-59	7.5	90	60	35
40-49	9.0	108	70	40

T402-b-2 Ship Holds and Storerooms That Contain Milled Products or With Appreciable Quantities of Tightly Packed or Baled Materials

Pest: *Trogoderma granarium* (khapra beetle)

Treatment: T402-b-2—MB (“Q” label only) at NAP

Temperature (°F)	Dosage Rate (lb/1,000 ft ³)	Minimum Concentration Readings (ounces) At:		
		0.5 hr	4 hrs	24 hrs ¹
90-96	4.0	48	35	25
80-89	6.0	72	50	30
70-79	8.0	96	65	35

1 In addition to the space concentration readings, you **must** take a commodity concentration reading. The minimum concentration reading for commodity reading is as follows: For 90-96 °F—10 oz.; for 80-89 °F—15 oz.; for 70-79°F—20 oz.

NOTICE

Concentration readings are **not** required for chamber fumigation.

NOTICE

Some ships’ masters or agents prefer to abandon flour or other finely milled products to qualify for the 12 hour schedule ([T401-b Railroad Cars \(Empty\)](#) on page 5-5-3). This practice should **not** be discouraged if PPQ approved incineration or steam sterilization facilities are available within the port city. Small quantities may be burned or boiled on board the vessel, but in **no** case should the material be removed from treatment in PPQ facilities. Such articles **must** be left in the storeroom during the 12-hour fumigation and then removed under PPQ safeguards. This will serve to reduce the possibility of pest dispersal when the articles are removed under PPQ supervision.

T402-e Articles Regulated for Gypsy moth (*Lymantria dispar*) and Spotted Lanternfly (*Lycorma delicatula*) Egg Masses

Treatment: T402-e —Surface Application and Physical Removal

1. Mix equal amounts of an APHIS-approved dormant oil spray and water to make a 50% mix. Make a fresh mix each day treatments are applied.

NOTICE

Currently, the only approved dormant oil spray is Golden Pest Spray Oil (Stoller Enterprises, Inc.; EPA Reg. No. 57538-11). No endorsement is intended and no discrimination is intended toward those products or companies not listed.

2. Physically remove the egg mass using a wire brush or paint scraper.
3. Apply the dormant oil spray to the egg mass and the area where the egg mass was removed using a small hand sprayer or a paint brush. Spray or paint individual egg masses until completely saturated. Agitate the mixture while treating.
4. Dispose of the egg masses according to local port procedures.

Golden Pest Spray Oil (EPA Reg. No. 57538-11) has been added under authorization of 7 CFR 305.3(b)(1)(3), is effective immediately, and is subject to change pending notice and public comment. (December 2021)

Apply according to the manufacturer labels and all state and local restrictions. Verify that it is registered for use in YOUR city, state, or county.

For life stages **other than** egg masses, refer to [T402-d Pests: Miscellaneous Hitchhiking Insects \(E.g., Crickets, Scarab Beetles, Ants, Africanized Honeybee Swarms, Spotted Lanternfly\)](#).

T403—Miscellaneous Cargo (Nonfood, Nonfeed Commodities)

T403-a-1 Miscellaneous Cargo (Nonfood, Nonfeed Commodities)

Pest: Quarantine-significant snails of the family Achatinidae, including the following genera: *Achatina*, *Archachatina*, *Lignus*, *Limicolaria*, *Lissachatina*

NOTICE

Do **not** use this treatment against snails in the subfamily Subulininae.

Treatment: T403-a-1—Use T402-a-1 for temperatures of 55 °F and above, use T403-a-6 for temperatures below 55 °F.

NOTICE

Commodity or product temperature **must** reach treatment temperature before exposure time begins.

T403-a-2-1 Miscellaneous Cargo (Nonfood, Nonfeed Commodities)

Pest: Quarantine-significant snails of the family Geomitridae and Hygromiidae, including the following genera: *Backeljaia*, *Candidula*, *Cernuella*, *Cochlicella*, *Helicella*, *Helicopsis*, *Hygromia*, *Monacha*, *Monachoides*, *Platytheba*, *Pseudotrachia*, *Trochoidea*, *Xerolenta*, *Xeropicta*, *Xeroplexa*, *Xerosecta*, *Xerotricha*

Treatment: T403-a-2-1—MB (“Q” label only) at NAP

Temperature (°F)	Dosage Rate (lb/1,000 ft ³)	Minimum Concentration Readings (ounces) At:				
		0.5 hr	2 hrs	24 hrs	48 hrs	72 hrs
55 and above	8.0	95	64	60	60	40

T403-a-2-2 Miscellaneous Cargo (Nonfood, Nonfeed Commodities)

Pest: Quarantine-significant snails of the family Geomitridae and Hygromiidae, including the following genera: *Backeljaia*, *Candidula*, *Cernuella*, *Cochlicella*, *Helicella*, *Helicopsis*, *Hygromia*, *Monacha*, *Monachoides*, *Platytheba*, *Pseudotrachia*, *Trochoidea*, *Xerolenta*, *Xeropicta*, *Xeroplexa*, *Xerosecta*, *Xerotricha*

Treatment: T403-a-2-2—MB in 26” vacuum

Temperature (°F)	Dosage Rate (lb/1,000 ft ³)	Exposure Period (hours)
70 and above	8.0	16

T403-a-2-3 Miscellaneous Cargo (Nonfood, Nonfeed Commodities)

Pest: Quarantine-significant snails of the family Geomitridae and Hygromiidae, including the following genera: *Backeljaia*, *Candidula*, *Cernuella*, *Cochlicella*, *Helicella*, *Helicopsis*, *Monacha*, *Platytheba*, *Pseudotrichia*, *Trochoidea*, *Xerolenta*, *Xeropicta*, *Xeroplexa*, *Xerosecta*, *Xerotricha*

Treatment: T403-a-2-3—Cold treatment (for temperatures below 55 °F)

Temperature (°F)	Exposure Period (hours)
0	48

T403-a-3 Miscellaneous Cargo (Nonfood, Nonfeed Commodities)

Pest: Quarantine-significant slugs of the families Agriolimacidae, Arionidae, Limacidae, Milacidae, Philomycidae, and Veronicellidae, including the following genera: *Agriolimax*, *Arion*, *Colosius*, *Deroceras*, *Diplosolenodes*, *Leidyula*, *Limax*, *Meghimatium*, *Milax*, *Pallifera*, *Pseudoveronicella*, *Sarasinula*, *Semperula*, *Vaginulus*, *Veronicella*

Treatment: T403-a-3—MB at NAP

Temperature (°F)	Dosage Rate (lb/ 1,000 ft ³)	Minimum Concentration Readings (ounces) At:	
		0.5 hr	2 hrs
90-96	1.0	12	9
80-89	1.25	15	12
70-79	1.5	18	15
60-69	1.75	22	19

T403-a-4-1 Miscellaneous Cargo (Nonfood, Nonfeed Commodities)

Pest: Quarantine-significant snails of the family Helicidae, including the following genera: *Arianta*, *Cepaea*, *Cornu*, *Helix*, *Massylaea*, *Otala*, *Theba*

Treatment: T403-a-4-1—MB at NAP

Temperature (°F)	Dosage Rate (lb/1,000 ft ³)	Minimum Concentration Readings (ounces) At:					
		0.5 hr	2 hrs	10 hrs	12 hrs	16 hrs	24 hrs
80 and above	6.0	70	48	40	–	–	–
55-79	6.0	70	48	–	–	40	–
40-54	8.0	96	64	–	–	–	39

T403-a-4-2 Miscellaneous Cargo (Nonfood, Nonfeed Commodities)

Pest: Quarantine-significant snails of the family Helicidae, including the following genera: *Cepaea*, *Cornu*, *Helix*, *Massylaea*, *Otala*, *Theba*

Treatment: T403-a-4-2—MB (“Q” label only) in 26” vacuum

Temperature (°F)	Dosage Rate (lb/1,000 ft ³)	Exposure Period (hours)
70 and above	6.0	6

T403-a-4-3 Miscellaneous Cargo (Nonfood, Nonfeed Commodities)

Pest: Quarantine-significant snails of the family Helicidae, including the following genera: *Arianta*, *Cepaea*, *Cornu*, *Helix*, *Otala*, *Theba*

Treatment: T403-a-4-3—Cold treatment, use [T403-a-6-1 Miscellaneous Cargo \(Nonfood, Nonfeed Commodities\)](#) on page 5-5-14 for temperatures below 55 °F.

T403-a-5-1 Miscellaneous Cargo (Nonfood, Nonfeed Commodities)

Pest: Quarantine-significant snails of the families Camaenidae (including the former Bradybaenidae) and Succineidae, including the following genera:
Acusta, Bradybaena, Cathaica, Omalonyx, Succinea

Treatment: T403-a-5-1—MB (“Q” label only) at NAP

Temperature (°F)	Dosage Rate (lb/ 1,000 ft ³)	Minimum Concentration Readings (ounces) At:			
		0.5 hr	2 hrs	10 hrs	16 hrs
80 and above	6.0	72	48	40	–
40-79	6.0	70	48	–	40

T403-a-5-2 Miscellaneous Cargo (Nonfood, Nonfeed Commodities)

Pest: Quarantine-significant snails of the families Camaenidae (including the former Bradybaenidae) and Succineidae, including the following genera:
Bradybaena, Cathaica, Omalonyx, Succinea

Treatment: T403-a-5-2—MB (“Q” label only) in 26” vacuum

Temperature (°F)	Dosage Rate (lb/1,000 ft ³)	Exposure Period (hours)
40 and above	6.0	6

T403-a-5-3 Miscellaneous Cargo (Nonfood, Nonfeed Commodities)

Pest: Quarantine-significant snails of the families Camaenidae (including the former Bradybaenidae) and Succineidae, including the following genera:
Bradybaena, Cathaica, Omalonyx, Succinea

Treatment: 403-a-5-3—Cold treatment, use [T403-a-6-1 Miscellaneous Cargo \(Nonfood, Nonfeed Commodities\)](#)

NOTICE

Commodity or product **must** reach treatment temperature before exposure time begins.

T403-a-6-1 Miscellaneous Cargo (Nonfood, Nonfeed Commodities)

Pest: Quarantine-significant snails sensitive to cold treatment, members of the families Camaenidae (including the former Bradybaenidae), Geomitridae, Helicidae, Helicellidae, Hygromiidae, and Succineidae, including the following genera: *Blackeljaia*, *Bradybaena*, *Candidula*, *Cepaea*, *Cathaica*, *Cernuella*, *Cochlicella*, *Helicella*, *Theba*, *Trochoidea*, *Xerolenta*, *Xeropicta*, *Xerosecta*, *Xerotricha*

Treatment: T403-a-6-1—Cold Treatment

Temperature (°F)	Exposure Period (hours)
0	48

T403-a-6-2 Miscellaneous Cargo (Nonfood, Nonfeed Commodities)

Pest: Quarantine-significant snails sensitive to cold treatment, certain members of the family Helicidae, including the following genera: *Helix*, *Otala*

Treatment: T403-a-6-2—Cold treatment

Temperature (°F)	Exposure Period (hours)
0	32
10	48

T403-a-6-3 Miscellaneous Cargo (Nonfood, Nonfeed Commodities)

Pest: Quarantine-significant snails sensitive to cold treatment, of the family Achatinidae, including the following genera: *Achatina*, *Archachatina*, *Lignus*, *Limicolaria*, *Lissachatina*

NOTICE

Do **not** use this treatment against snails in the subfamily Subulininae.

Treatment: T403-a-6-3—Cold treatment

Temperature (°F)	Exposure Period (hours)
0	8
10	16
20	24

T403-b Miscellaneous Cargo (Nonfood, Nonfeed Commodities)

Pest: *Trogoderma granarium* (khapra beetle)

Treatment: T403-b—MB at NAP, use [T401-b Railroad Cars \(Empty\)](#) on page 5-5-3 or [T402-b-2 Ship Holds and Storerooms That Contain Milled Products or With Appreciable Quantities of Tightly Packed or Baled Materials](#) on page 5-5-8.

T403-c Miscellaneous Cargo (Nonfood, Nonfeed Commodities)

Pest: *Globodera rostochiensis* (golden nematode)

Treatment: T403-c—MB (“Q” label only) in 26” vacuum

Temperature (°F)	Dosage Rate (lb/1,000 ft ³)	Exposure Period (hours)
40 and above	8.0	16
	10.5	12
	16.0	8

T403-d Miscellaneous Cargo (Nonfood, Nonfeed Commodities)

Pest: Wood borers or termites

Treatment: T403-d see T404 schedules

T403-e-1-1 Miscellaneous Cargo (Nonfood, Nonfeed Commodities) That is Not Sorptive or Difficult to Penetrate

Pest: Quarantine-significant insects **not** specifically provided for elsewhere in nonfood or nonfeed commodities

Treatment: T403-e-1-1—MB (“Q” label only) at NAP—tarpaulin

Temperature (°F)	Dosage Rate (lb/1,000 ft ³)	Minimum Concentration Readings (ounces) At:		
		0.5 hr	2hrs	12 hrs
90 and above	2.5	30	20	15
80-89	3.5	42	30	20
70-79	4.5	54	40	25
60-69	6.0	72	50	30
50-59	7.5	90	60	35
40-49	9.0	108	70	40

T403-e-1-2 Miscellaneous Cargo (Nonfood, Nonfeed Commodities) That is Sorptive or Difficult to Penetrate

Pest: Quarantine-significant insects **not** specifically provided for elsewhere in nonfood or nonfeed commodities

Treatment: T403-e-1-2—MB (“Q” label only) at NAP

Temperature (°F)	Dosage Rate (lb/1,000 ft ³)	Minimum Concentration Readings (ounces) At:				
		0.5 hr	4 hrs	24 hrs	28 hrs	32 hrs
90-96	4.0	48	35	25 ¹	—	—
80-89	6.0	72	50	30 ¹	—	—
70-79	8.0	96	65	35 ¹	—	—
60-69	12.0	144	95	50 ¹	—	—
50-59	12.0	144	95	—	50 ¹	—
40-49	12.0	144	95	—	—	50 ¹

1 In addition to the space concentration readings, you **must** take a commodity concentration reading. The minimum concentration reading for commodity reading is as follows: For 90-96 °F—10 oz.; for 80-89 °F—15 oz.; for 70-79°F—20 oz.; for 60-69 °F—30 oz.; for 50-59 °F—30 oz.; and 40-49 °F—30 oz.

This fumigation schedule may be used, for example, on finely milled products and on material that is tightly packed or baled.

T403-e-2 Miscellaneous Cargo (Nonfood, Nonfeed Commodities) That is Not Sorptive or Difficult to Penetrate

Pest: Quarantine-significant pests other than insects, including quarantine-significant snail families Helicarionidae and Streptaxidae, and subfamily Subulininae

Treatment: T403-e-2—MB (“Q” label only) at NAP—tarpaulin or chamber

Temperature (°F)	Dosage Rate (lb/1,000 ft ³)	Minimum Concentration Readings (ounces) At:			
		0.5 hr	2 hrs	24 hrs	48 hrs
40 and above	10.0	140	130	120	80

T403-f Miscellaneous Cargo (Nonfood, Nonfeed Commodities)

Pest: *Pieris* spp. (cabbageworms, all life stages) and all other *Lepidoptera*¹. Also hitchhiking insects, including non-*Lepidoptera*.

Treatment: T403-F—MB at NAP

Temperature (°F)	Dosage Rate (lb/1,000 ft ³)	Minimum Concentration Readings (ounces) At:	
		0.5 hr	3 hrs
70 and above	3.0	36	16
60-69	3.5	40	19
50-59	4.0	45	21
45-49	4.5	49	24
40-44	5.0	54	27

¹ A 3-hour exposure easily kills all Lepidopterous hitchhikers, including gypsy moth, and is preferred over using the much longer schedules that are aimed more at khapra beetles (T404-b-1 and T402-b-2). This schedule should not be used for mollusks (snails and slugs), any insect with cryptic habits (e.g., ants or borers), or for insects in diapause.

T404—Wood Products² Including Containers

T404-b-5-1 Surface Spray for the Following Pests: Borers (Wood Wasps, Anobiidae, Bostrichiadae, Cerambycidae, and Lyctidae), Carpenter Ants, and Other Wood Infesting Ants, Carpenter Bees, and Termites

Treatment: T404-b-5-1—Surface application

Refer to [Table 5-5-7](#) for label-approved surfaces. Always refer to the manufacturer’s label for specific areas of use.

Table 5-5-3 T404-b-5-1 Chemical Alternatives

Active Ingredient ¹	Examples of Trade Names and EPA Registration Numbers (list not all-inclusive) ²
Chlorpyrifos	Whitmire PT, Duraguard ME (#499-367)
Cypermethrin 25.3% a.i.	Demon [®] EC (#100-1004)

- 1 Apply at the highest rate allowed for the site and the pest on the label. (active ingredient = a.i.)
- 2 **No** endorsement is intended of the particular items listed and **no** discrimination is intended toward those products or companies that may **not** be listed. Use other formulations as long as the application method, site, and rate are listed on the label.

T404-a Wood Products Including Containers

Pest: *Globodera rostochiensis* (golden nematode)

Treatment: T404-a—MB (“Q” label only) in 26” vacuum

Temperature (°F)	Dosage Rate (lb/1,000 ft ³)	Exposure Period (hours)
40 and above	8.0	16
	10.5	12
	16.0	8

² Bamboo: use [T404-d Wood Products Including Containers](#) on page 5-5-24 for the fumigation of any bamboo products.

T404-b-2 Wood Products Including Containers

Pest: Borers (wood wasps, carpenter ants, carpenter bees, and termites)

Treatment: T404-b-2—SF at NAP

Temperature (°F)	Dosage Rate (lb/1,000 ft ³)	Minimum Concentration Readings (ounces) At:						
		0.5 hr	2 hrs	4 hrs	12 hrs	16 hrs	24 hrs	32 hrs
70 and above	4.0	48	45	40	–	32	–	–
60-69	4.0	48	45	40	36	–	32	–
50-59	5.0	60	56	52	48	–	40	–
40-49	6.5	76	71	66	60	–	52	–
	5.0	60	57	53	49	–	44	40

NOTICE

Do **not** use a filter containing sodium hydroxide (Ascarite®) with this fumigant.

Sulfuryl fluoride (SF) is **NOT** an approved quarantine treatment for wood-boring beetles because SF has difficulty in penetrating insect eggs; therefore, many eggs will still hatch following fumigation. SF treatment of wood should be authorized only for brood-tending species of insects, such as termites, bees, wasps, and ants. Even if all eggs are **not** killed, the hatching larvae will die of starvation due to lack of care.

T404-b-1-1 Wood Products Including Containers

WARNING

An Ascarite® filter **must** be mounted on the T/C analyzer when taking concentration readings for T404-b-1-1 treatment.

Pest: See the pest list in [Table 5-5-5](#).

Treatment: T404-b-1-1—MB at NAP—tarpaulin or chamber

Temperature (°F)	Dosage Rate (lb/ 1,000 ft ³)	Minimum Concentration Readings (ounces) At:			
		0.5 hr ¹	2 hrs ²	4 hrs ³	16 hrs ³
70 and above	3.0	36	30	27	25
40-69	5.0	60	51	46	42

- 1 If the fumigation is conducted in a closed-door container, take the first reading at 1 hour instead of 0.5 hours.
- 2 If the fumigation is conducted in a closed-door container, take the second reading at 2.5 hours instead of 2 hours.
- 3 If the 4- and 16-hour readings would occur outside of normal working hours, then the fumigation may be extended to a total of 24 hours, instead of 16. In that case, the 24-hr. minimum concentration reading would be 25 (for the initial 3 lb. dosage), or 42 (for the initial 5 lb. dosage).

Table 5-5-4 Metric Equivalents for T404-b-1-1

Temperature (°F)	Dosage Rate (lb/1,000 ft ³)	Temperature (°C)	Dosage Rate (g/m ³)
70 or above	3.0	21 or above	48
46-69	5.0	5-20	80

T404-b-1-2 Wood Products Including Containers

Pest: See the pest list in [Table 5-5-5](#)

Treatment: T404-b-1-2—MB in 26” vacuum

Temperature (°F)	Dosage Rate (lb/1,000 ft ³)	Exposure Period (hours)
70 and above	4.0	4
40-69	4.0	5

T404-b-4 Wood Products Including Containers

Pest: See the pest list in [Table 5-5-5](#)

Treatment: T404-b-4—Kiln sterilization

Dry Bulb Temperature (°F)	Wet Bulb Depression (°F)	Relative Humidity (%)	Moisture Content (%)	Thickness of Lumber (inches)	Treatment Time After Kiln Reaches Conditions (hours)
140	7	82	13.8	1	3
				2	5
				3	7
130	16	60	9.4	1	10
				2	12
				3	14
125	15	61	9.7	1	46
				2	48
				3	50

Table 5-5-5 Pest List for T404-b-1-1, T404-b-1-2, and T404-b-4

<p>Coleoptera (beetles):</p> <ul style="list-style-type: none"> ◆ Buprestidae (metallic or flat-headed borers) ◆ Cerambycidae (long-horned or round-headed borers) ◆ Curculionidae (wood-boring and root-feeding weevils) also includes: <ul style="list-style-type: none"> ❖ Scolytinae (bark/engraver beetles; also ambrosia/timber beetles) ❖ Platypodinae (pin-hole borers) ◆ Lymexylonidae (ship timber beetles) ◆ Passalidae (bess beetles) ◆ Platypodidae (pin-hole borers) ◆ Rhizophagidae (root-eating beetles) ◆ Salpingidae (narrow-wasted bark beetles) ◆ Scolytidae (bark/engraver beetles; also ambrosia/timber beetles) ◆ Trogositidae (bark-gnawing beetles)
<p>Hymenoptera (bees, wasps, and ants):</p> <ul style="list-style-type: none"> ◆ Formicidae (carpenter ants) ◆ Orussidae (parasitic wood wasps) ◆ Siricidae (wood wasps) ◆ Syntexicae (incense-cedar wood wasps) ◆ Xylocopidae (carpenter bees) ◆ Xyphydriidae (wood wasps)

Table 5-5-5 Pest List for T404-b-1-1, T404-b-1-2, and T404-b-4 (continued)

Isoptera (termites)
Lepidoptera (moths):
◆ Cossidae (carpenter worms)
◆ Sesiidae (clear-winged moths)

NOTICE

1. Minimum concentration **must** be met in chamber fumigations of sorptive materials. (Refer to [Sorption](#) on page 2-3-10.)
2. For fumigation of hardboard (Masonite), an initial dosage of 10 lb/1,000 ft³ is recommended. Inspector should be prepared to provide extra attention to maintaining minimum concentrations when fumigating this commodity.
3. If both termites and borers are present at 40-69 °F, use [T404-b-1-1 Wood Products Including Containers](#) on page 5-5-20 with exposure extended to 20 hours. Use same minimum concentrations.
4. Water vapor or other gases may be evolved during the fumigation and give false (additive) readings on the gas analyzer. Use an both and Ascarite® filter and a Drierite® filter if the wood is uncured (green) or if the wood is manifested as guatamba wood.
5. If the 4- and 16-hour readings would occur outside of normal working hours, then the fumigation may be extended to a total of 24 hours instead of 16. In that case, the 24-hr minimum concentration reading would be 25 (for the initial 3 lb dosage), or 42 (for the initial 5 lb dosage).
6. When conducting the fumigation with the container doors open, resume use of fans anytime a difference of **4 oz. or more** occurs between the highest and lowest reading.
7. When conducting the fumigation with the container doors closed, resume use of fans anytime a difference of **10 oz. or more** occurs between the highest and lowest reading.
8. Readings more than 5 oz. below minimum at end of exposure negates treatment. For readings less than 5 oz. below minimum at the end of exposure period, add 2 oz/1,000 ft³ for each ounce below minimum and extend exposure for 4 hours.
9. A reduction in dosage is allowed when fumigating nonsorptive commodities, such as marble, shells, metal containers, etc., which have infested crating associated with them, providing the following additional conditions are met:
 - Use only new 4-mil or 6-mil tarpaulins.
 - **No** truck trailer, van, or railroad car fumigations are permitted unless the carrier is covered with a 6-mil tarpaulin, which is then sealed to the ground.
 - Use five or more sampling leads to determine minimum concentrations.
10. When fumigating wood commodities (e.g., dunnage, crating, logs) the proper fumigation temperature may be determined by inserting the tip of a dial thermometer or other temperature probe in a hole in the wood. A hole can be made with an electric or hand-powered drill or an awl. The hole diameter should be just large enough to insert the probe shaft (to lessen the influence of surrounding air). The depth should be 2 inches or half the thickness of the wood. Different areas of the load should be probed and the lowest temperature used in determining fumigation temperature. Determine the wood temperature 5 to 10 minutes after drilling the hole to allow the heat generated during drilling to dissipate.

T404-c-1-1 Wood Products Including Containers

WARNING

If using a T/C analyzer, an Ascarite® filter **must** be mounted when taking concentration readings for T404-c-1-1.

Pest: Termites

Treatment: T404-c-1-1—MB at NAP—tarpaulin or chamber

Temperature (°F)	Dosage Rate (lb/1,000 ft ³)	Minimum Concentration Readings (ounces) At:				
		0.5 hr	2 hrs	4 hrs	16 hrs	24 hrs
40 and above	3.0	36	30	27	25	24

NOTICE

Minimum concentration **must** be met in NAP chamber fumigations of sorptive materials. See [Sorption](#) on page 2-3-10 for a list of sorptive materials.

If **both termites** and **borers** are present at 40-60 °F, use [T404-b-1-1 Wood Products Including Containers](#) on page 5-5-20 with exposure extended to 20 hours. Use same minimum concentrations.

T404-c-1-2 Wood Products Including Containers

Pest: Termites

Treatment: T404-c-1-2—MB in 26” vacuum

Temperature (°F)	Dosage Rate (lb/1,000 ft ³)	Exposure Period
70 and above	4.0	3
40-69	4.0	4

T404-c-2 Wood Products Including Containers

Pest: Termites

Treatment: T404-c-2—SF at NAP (Do **not** use filters containing Ascarite® with this fumigant.)

Temperature (°F)	Dosage Rate (lb/ 1,000 ft ³)	Minimum Concentration Readings (ounces) At:			
		0.5 hr	2 hrs	16 hrs	24 hrs
70 and above	1.0	12	8	8	–
60-69	1.5	18	12	–	8
50-59	2.5	32	20	–	20

T404-d Wood Products Including Containers

WARNING

If using a T/C Analyzer, an Ascarite® filter **must be used**.

Pest: Borers and *Trogoderma granarium* (khapra beetle)

Treatment: T404-d—MB at NAP—tarpaulin or chamber

Temperature (°F)	Dosage Rate (lb/1,000 ft ³)	Minimum Concentration Readings (ounces) At:				
		0.5 hr ¹	2 hrs ²	4 hrs	16 hrs ³	24 hrs ³
80 and above	3.5	36	33	30	25	17
70-79	4.5	50	45	40	25	22
60-69	6.0	65	55	50	42	29
50-59	7.5	80	70	60	42	36
40-49	9.0	85	76	70	42	42

- 1 If the fumigation is conducted in a closed-door container, take the first reading at 1 hour instead of 0.5 hours.
- 2 If the fumigation is conducted in a closed-door container, take the second reading at 2.5 hours instead of 2 hours.
- 3 If the 16-hour reading is **not** performed, the 24-hour reading **must** have the following minimum concentrations: For 80 °F or above—25 oz.; for 70-79°F—25 oz.; for 60-69 °F—42 oz.; for 50-59 °F—42 oz.; and 40-49 °F—42 oz.

Table 5-5-6 Metric Equivalentents for T404-d

Temperature (°F)	Dosage Rate (lb/1,000 ft ³)	Temperature (°C)	Dosage Rate (g/m ³)
80 or above	3.5	27 or above	56
70-79	4.5	21-26	72
60-69	6.0	16-20	96
50-59	7.5	10-15	120
40-49	9.0	5-9	144

When fumigating containerized bamboo:

- ◆ If the bamboo is packaged, the packaging must be permeable to methyl bromide. If it is not permeable, require the fumigator to remove or puncture the packaging.
- ◆ Bamboo must be on pallets or have at least 2 inches of clearance at the bottom of the container. If the bamboo is being fumigated in a refrigerated container, the 2" clearance cannot be created by the I-beam floor of the container, the bamboo bundles, or by steel poles.



Photo Courtesy of USDA-APHIS-PPQ

Figure 5-5-1 Example of Inadequate Spacing Under Bamboo Bundles



Figure 5-5-2 Example of Inadequate Spacing Under Bamboo Bundles

- ◆ There must be at least 18" of clearance on the top of the commodity to allow for gas circulation and introduction fans.



Figure 5-5-3 Example of Adequate Space Above Bamboo Bundles

Partial Site List for Chemical Treatments

Always refer to the manufacturer’s label for specific areas of use. [Table 5-5-7](#) is **not** all-inclusive and is intended as a quick reference for PPQ officials. The label of the chemical you are using **must** list the site you want to treat.

Table 5-5-7 Partial Site List

Active Ingredient	Partial Site List
Deltamethrin	Food/feed and nonfood/nonfeed areas of: aircraft (cargo only), apartment buildings, bakeries, bottling facilities, breweries, buses, cafeterias, candy plants, canneries, dairy product processing plants, food manufacturing plants, food processing plants, food service establishments, granaries and grain mills, hospitals, hotels, houses, industrial buildings, installations, kitchens, laboratories, mausoleums, meat, poultry, and egg processing and packaging plants, mobile and motor homes, nursing homes, offices, railcars, restaurants, schools, ships and vessels, trailers, trucks, warehouses, wineries
Chlorfenapyr	Basements, bathrooms/lavatories, breweries, building foundations, canneries, concrete slabs, dairies, domestic dwelling, eating establishments, food marketing/storage/distribution facilities, food processing plants, garages, garbage rooms, hospitals, hotels/motels/tourist courts, meat/poultry processing plants, nursing homes, sewers, storage areas, supermarkets, wood structures, zoos
Chlorpyrifos	Indoors, pet kennels, general surface application, barrier application, spot or crack and crevice applications, general outdoor treatment, perimeter treatments, turf grass, ornamentals, commercial ornamentals, greenhouses, and nurseries
β-Cyfluthrin	Food/feed and nonfood/nonfeed areas of: aircraft (cargo only), apartment buildings, bakeries, bottling facilities, breweries, buses, cafeterias, candy plants, canneries, dairy product processing plants, food manufacturing plants, food processing plants, food service establishments, granaries and grain mills, hospitals, hotels, houses, industrial buildings, installations, kitchens, laboratories, mausoleums, meat, poultry, and egg processing and packaging plants, mobile and motor homes, nursing homes, offices, outdoor pest control, perimeter spray, railcars, restaurants, schools, ships and vessels, trailers, trucks, warehouses, wineries
Cyfluthrin	In and around buildings and structures; on residential, commercial and recreational areas of turf; on ornamentals in landscapes and interior plantscapes; modes of transport; wood infesting pests; apartments, calf hutches, calving pens and parlors, campgrounds, empty chicken houses, dairy areas, dog kennels, food storage areas, grain mills, granaries, hog barns, homes, horse barns, hospitals, hotels, meat packing plants, food processing plants, milk rooms, motels, nursing homes, rabbit hutches, resorts, restaurants and other food handling establishments, schools, supermarkets, transportation equipment (buses, boats, ships, trains, trucks, planes (cargo area only), utilities, warehouses, commercial and industrial buildings
Cypermethrin	Buildings and structures and immediate surroundings, modes of transport, industrial buildings, houses, apartment buildings, laboratories, buses, greenhouses, and nonfood/nonfeed areas of stores, warehouses, vessels, railcars, trucks, trailers, aircraft (cargo areas only), schools, nursing homes, hospitals (non-patient areas), restaurants, hotels and food manufacturing, processing, and servicing establishments, outdoor surfaces, barrier treatment, treatment of preconstruction lumber and logs

Table 5-5-7 Partial Site List (continued)

Active Ingredient	Partial Site List
Lambda-Cyhalothrin	Perimeter treatments, indoor and outdoor treatments, aircraft (cargo and other non-cabin areas only), apartment buildings, boiler rooms, buses, closets, correctional facilities, decks, entries, factories, fencing, floor drains (that lead to sewers), food granaries, food grain mills, food manufacturing, processing and serving establishments; furniture, garages, garbage rooms, greenhouses (noncommercial), hospitals, hotels and motels; houses, industrial buildings, laboratories, livestock/poultry housing, landscape vegetation, locker rooms, machine rooms, mausoleums, mobile homes, mop closets, mulch, nursing homes, offices, patios, pet kennels, porches, railcars, restaurants, storage rooms, schools, sewers (dry), stores, trailers, trees, trucks, utility passages, vessels, vestibules, warehouses, wineries, and yards
Malathion	Perimeter barrier treatments, outdoor surfaces, ornamentals, turf, mushroom houses, grain elevators and silos being prepared to store barley, corn, oats, rye, or wheat

T404-e—Approved Marking for Regulated Wood Packing Material

The wood packing material³ **must** be stamped in a visible location on each article, with a legible and permanent mark that indicates the article has met the treatment required. The mark **must** be approved by the International Plant Protection Convention (IPPC). The currently approved mark is shown in [Figure 5-5-4](#). XX would be replaced by the country code, 000 by the producer number, and YY by the treatment type (HT or MB).

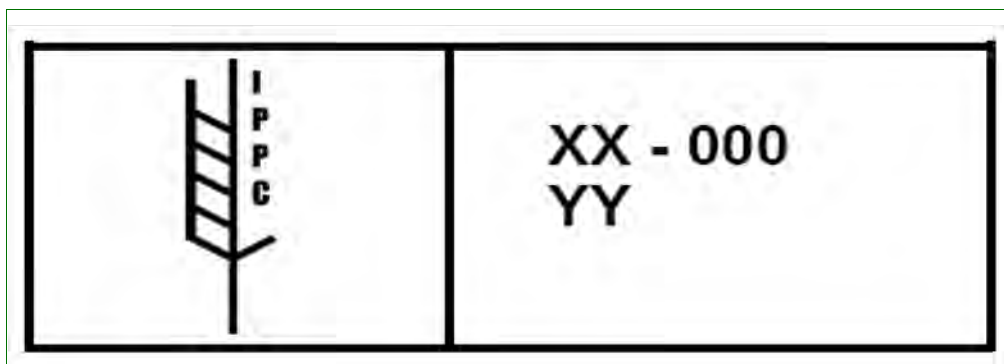

Figure 5-5-4 Example of International Plant Protection Convention Marking

T404-e-1—Regulated Wood Packing Material (WPM)

Pest: Various

- 3 Regulated wood packing material is defined as all types of wood packaging materials used for or for use with cargo to prevent damage, including, but **not** limited to: dunnage, crating, pallets, packing blocks, drums, cases, and skids. **Excluded** from the definition of packaging materials are:
- ◆ Pieces of wood that are less than 6mm or 0.24 inches in any dimension
 - ◆ Loose wood packing materials, such as wood shavings, excelsior, etc.
 - ◆ Processed wood packing materials that have received more than primary processing, such as plywood, corrugated board, fiberboard, veneer, whiskey and wine barrels, oriented strand boards, etc.

Treatment: T404-e-1—MB at NAP—tarpaulin

Temperature (°F)	Dosage Rate (lb/1,000 ft ³)	Minimum Concentration Readings (ounces) At:				
		0.5 hr ¹	2 hrs ²	4 hrs	16 hrs	24 hrs
69.8 and above	3.0	36	36	31	28	24
61-69.8	3.5	42	42	36	32	28
51.8-61	4.0	48	48	42	36	32

- 1 If the fumigation is conducted in a closed-door container, take the first reading at 1.0 hour instead of 0.5 hours.
- 2 If the fumigation is conducted in a closed-door container, take the second reading at 2.5 hour instead of 2.0 hours.

Table 5-5-8 Metric Equivalents for T404-e-1

Temperature (°F)	Dosage Rate (lb/1,000 ft ³)	Temperature (°C)	Dosage Rate (g/m ³)
69.8 or above	3.0	21 or above	48
61-69.8	3.5	16-20.9	56
51.8-61	4.0	11-15.9	64

T404-e-2 Regulated Wood Packing Material (WPM)

Pest: Various

Treatment: T404-e-2

Heat treatment to achieve a minimum core temperature of 56 °C (132.8 °F) for a minimum of 30 minutes. Treatments **must** be conducted in USDA-approved facilities. Contact S&T-TMT for facility specifications.

T404-f *Pinus radiata* Wood Chips From Chile and *Eucalyptus* Wood Chips From South America

Treatment: T404-f—Surface pesticide

Refer to [Table 5-5-9](#) for the chemical name and percentage of active ingredients. Spray the wood chips with the pesticide mixture so that all the chips are completely exposed to the chemicals. To prevent against infestation by plant pests, safeguard the wood chips during the interval between treatment and export.

Treatment Schedules T400 - Schedules for Miscellaneous Products

T404-f *Pinus radiata* Wood Chips From Chile and *Eucalyptus* Wood Chips From South America

Table 5-5-9 Pesticide Treatment for *Pinus radiata* and *Eucalyptus* Wood Chips

Percentage of Active Ingredient (a.i.)	Pesticide
64.8	didecyl dimethyl ammonium chloride
7.6	3-iodo-2-propynyl butylcarbamate
44.9	chlorpyrifos phosphorothioate

T405—Bags and Bagging Material

See T306 schedules.

T406—Golden Nematode Contaminations

T406-a Miscellaneous Cargo (Nonfood, Nonfeed Commodities)

Pest: *Globodera rostochiensis* (golden nematode)

Treatment: T406-a—MB in 26” vacuum, use [T403-c Miscellaneous Cargo \(Nonfood, Nonfeed Commodities\)](#) on page 5-5-15.

T406-c Piers, Barges, Railroad Cars, Automobiles, Used Farm Equipment, etc.

Pest: *Globodera rostochiensis* (golden nematode)

Treatment: T406-c—Steam cleaning

Steam at high pressure until all soil is removed. Treated surfaces should be thoroughly wet and heated. The debris and/or runoff from the cleaning procedure **must** be handled in a manner approved by local and port authority guidelines.

T406-b Used Farm Equipment, Construction Equipment, Containers, etc.

Pest: *Globodera rostochiensis* (golden nematode)

Treatment: T406-b—MB (“Q” label only) at NAP—tarpaulin or chamber

Temperature (°F)	Dosage Rate (lb/1,000 ft ³)	Minimum Concentration Readings (ounces) At:		
		0.5 hr	2 hrs	24 hrs
60 and above	15.0	180	120	120

NOTICE

Soil should be easily crumbled, but **not** wet. The soil should **not** exceed 12 inches in the smallest dimension.

T406-d Used Farm Equipment (Without Cabs), Construction Equipment (Without Cabs), and Used Containers

Pest: *Globodera rostochiensis* (golden nematode)

Treatment: T406-d—Steam at NAP—tarpaulin or tent

Steam heat for 60 minutes after all temperature sensors reach 140 °F (60 °C).
(See sensor placement and other requirements below)

NOTICE

This treatment **must** be conducted under the following minimum ambient air temperatures, which will vary with the volume of the treatment enclosure:

- ◆ For treatment enclosures of 4,000 ft³ or less, the minimum air temperature is 40 °F.
- ◆ For treatment enclosures greater than 4,000 ft³ and less than or equal to 6,000 ft³, the minimum air temperature is 60 °F.

This treatment is **not** recommended for treatment enclosures greater than 6,000 ft³.

Step 1: Determine if the temperature and volume requirements can be met

If you **cannot** meet the temperature and enclosure volume requirements, do **not** use this treatment.

Step 2: Assemble articles to be treated

Place articles to be treated as close together as possible. Arrange articles to allow space for placement of the steam distribution manifold.

Step 3: Place the steam distribution manifold pipe beneath articles to be treated

Assemble the steam distribution manifold and place beneath the articles to be treated in order to facilitate steam distribution. A flexible steam introduction hose, approximately 20 feet in length, connects the steam generator to a 10 foot long U-shaped pipe capped at the ends, with 0.5 inch holes every 12 inches. This pipe serves as the steam distribution manifold.

Step 4: Place temperature recording sensors on the article to be treated

Enclosures of 4,000 ft³ or less

When treatment is being conducted in enclosures of 4,000 ft³ or less, use at least 4 temperature recording sensors in addition to the sensor on the steam generator. Place sensors in hard-to-treat cracks or crevices on the equipment or containers. Position sensors in the following locations:

1. Front high—near the top of the front of the equipment or load

2. Center middle—midway from the top and bottom of the center of the equipment or load
3. Center bottom—bottom of the center of the equipment or load, but at least 3 inches above the floor if the equipment is flush with the floor
4. Rear bottom—bottom of the rear of the equipment, but at least 3 inches above the floor if the equipment is flush with the floor

Enclosures greater than 4,000 ft³ and less than or equal to 6,000 ft³

When the treatment is being conducted in enclosures greater than 4,000 ft³ and less than or equal to 6,000 ft³, use at least 8 temperature recording sensors in addition to the sensor on the steam generator. Again, place sensors in hard-to-treat cracks or crevices on the equipment or containers. Position probes in the following locations:

1. Front high—near the top of the left side of the front of the equipment or load
2. Front low—bottom of the right side of the front of the equipment or load, but at least 3 inches above the floor if the equipment is flush with the floor
3. Center high—near the top of the center of the equipment or load on the right side
4. Center middle—midway from the top and bottom of the center of the equipment or load
5. Center low—bottom of the center of the equipment or load on the left side, but at least 3 inches above the floor if the equipment is flush with the floor
6. Rear high—near the top of the rear of the equipment on the right side
7. Rear middle—midway from the top and bottom of the rear of the equipment
8. Rear low—bottom of the rear of the equipment or load on the left side, but at least 3 inches above the floor if the equipment is flush with the floor

Step 5: Enclose the article to be treated with a tarpaulin or tent

If a tarpaulin (6 mil plastic) is used instead of a tent, pad sharp edges of the equipment or containers before covering with the tarp.

If the equipment or containers will be moved into an enclosure, such as a tent, it may be more practical to place the temperature sensors after this step. In

either case, the front of the equipment or load and the front of the enclosure should face in the same direction.

Step 6: Place the steam generator at an open end of the enclosure and seal the enclosure

The steam generator is placed approximately 20 feet from the front of the enclosure and connected to a steam introduction line (hose). The steam introduction line is connected to the steam distribution manifold pipe which is situated under the articles to be treated. The enclosure is sealed at the base, including the point at which the introduction line enters the enclosure. An airtight seal is **not** essential for steam treatment; therefore, small pinholes are acceptable.

Step 7: Steam heat the enclosure for 60 minutes after all temperature sensors reach a minimum 140 °F (60 °C)

NOTICE

Use only a steam generator approved by APHIS.

The maximum temperature in the enclosure should **not** exceed 160 °F (71 °C).

Record the temperature once every 2 minutes during the treatment.

T407—Mechanical Cotton Pickers and Other Cotton Equipment

T407 Mechanical Cotton Pickers and Other Cotton Equipment

Pest: *Pectinophora gossypiella* (pink bollworm)

Treatment: T407—MB (“Q” label only) at NAP—tarpaulin, chamber, railroad car, or van

Temperature (°F)	Dosage Rate (lb/1,000 ft ³)	Minimum Concentration Readings (ounces) At:				
		0.5 hr	2 hrs	3 hrs	4 hrs	12 hrs
40 and above	4.0	48	–	–	–	21
	8.0	96	–	64	–	–

NOTICE

This treatment is designed to kill exposed larvae, larvae within green cotton bolls or single locks of seed cotton, or loose trash. Any materials such as sacked or bulked seed, cotton waste, lint, linters, or any packaged commodity shall be treated in accordance with T301.

T408—Soil as Such and Soil Contaminating Durable Commodities

T408-e-1 Herbarium Specimens of Mosses and Liverworts in Soil and Originating in Golden Nematode-free Countries

Pest: (precautionary)

Treatment: T408-e-1—MB (“Q” label only) in 26” vacuum (precautionary fumigation)

Temperature (°F)	Dosage Rate (lb/1,000 ft ³)	Exposure Period (hours)
70 and above	2.0	3.5

T408-e-2 Herbarium Specimens of Mosses and Liverworts in Soil and Originating in Golden Nematode-free Countries

Pest: *Globodera rostochiensis* (golden nematode)

Treatment: T408-e-2—MB (“Q” label only) in 26” vacuum

Temperature (°F)	Dosage Rate (lb/1,000 ft ³)	Exposure Period (hours)
40 and above	8.0	16
	10.5	12
	16.0	8

T408-a Soil As Such

Two alternative treatments

Pest: Various pests and pathogens found in soil (including striga)

Treatment: T408-a—Dry heat

Temperature (°F)	Exposure Period
230 to 249	16 hours
250 to 309	2 hours
310 to 379	30 minutes
380 to 429	4 minutes
430 to 450	2 minutes

Spread soil evenly throughout the treatment chamber. Soil depth **must not** exceed 6 inches. Take temperature readings using a calibrated temperature probe at various locations throughout the entire mass. The exposure period does **not** begin until the entire mass reaches treatment temperature, as verified by a calibrated temperature probe.

NOTICE

Contact S&T-TMT for information regarding placement and number of temperature probes.

T408-b Soil As Such

Pest: Various pests and pathogens found in soil

Treatment: T408-b—Steam—250 °F at 15 lbs pressure (psi) for 0.5 hour

Preheat laboratory autoclaves. Restrict soil depth to 2 inches when treating quantities of soil in trays. Restrict each package weight to 5 lbs. or less when treating individual packages. Load with adequate spacing. Large commercial steam facilities which operate at pressures up to 60 lbs. psi will permit treatment of greater soil depth.

T408-b-1 Soil Contaminating Durable Commodities (e.g., Equipment, Cobblestone, Marble)

Pest: Various pests and pathogens found in soil

Treatment: Steam cleaning

Steam at high pressure until all soil is removed. Treated surfaces should be thoroughly wet and heated. The debris and/or runoff from the cleaning procedure **must** be handled in a manner approved by local and port authority guidelines.

T408-c-1 Soil As Such

Pest: *Globodera rostochiensis* (golden nematode)

Treatment: T408-c-1—MB (“Q” label only) in 26” vacuum, see [T403-c Miscellaneous Cargo \(Nonfood, Nonfeed Commodities\)](#) on page 5-5-15 for loose and friable material only.

Soil to be fumigated in containers—**no** dimensions of which can exceed 24 inches.

T408-c-2 Soil As Such

Pest: *Globodera rostochiensis* (golden nematode)

Treatment: T408-c-2—MB (“Q” label only) at NAP—tarpaulin or chamber

Temperature (°F)	Dosage Rate (lb/1,000 ft ³)	Minimum Concentration Readings (ounces) At:		
		0.5 hr	2 hrs	24 hrs
60 and above	15.0	180	120	72

NOTICE

Soil should be friable, moist, but **not** wet. Soil **must not** be more than 12 inches in depth. If stacked in containers, 12 inches of space **must** be left between levels.

T408-d-1 Soil As Such

Pest: Insects

Treatment: T408-d-1—Screening through 16 mesh screens will remove most larvae and pupae, **except** smaller types

T408-d-2 Soil As Such

Pest: Insects

Treatment: T408-d-2—Freezing—0 °F for 5 days

T408-f Soil Contaminated Durable Commodities (e.g., Equipment, Cobblestone, Marble) (Precautionary Treatment)

Pest: Soil fungi, nematodes, and certain soil insects

Treatment: T408-f—Steam cleaning

Steam at high pressure until all soil is removed. Treated surfaces should be thoroughly wet and heated.

The debris and/or runoff from the cleaning procedure **must** be handled in a manner approved by local and port authority guidelines.

T408-g-1 Soil Contaminated Nonfood or Nonfeed Commodities

Pest: *Striga* spp. (witchweed)

Treatment: T408-g-1—MB (“Q” label only)—tarpaulin

Temperature (°F)	Dosage Rate (lb/1,000 ft ³)	Exposure Period (hours)
60 and above	10.0	24
	20.0	15.5

T408-g-2 Soil Contaminated Nonfood or Nonfeed Commodities

Pest: *Striga* spp. (witchweed)

Treatment: T408-g-2—MB (“Q” label only)—tarpaulin

Temperature (°F)	Dosage Rate (lb/1,000 ft ³)	Minimum Concentration Readings (ounces) At:		
		0.5 hr	2 hrs	24 hrs
60 and above	15.0	164	120	72

NOTICE

Soil **must** be friable, moist, but **not** wet. The soil shall **not** exceed 12 inches in least dimension.

T409—Aircraft

Refer to the Chemical Treatments section for [Aerosols](#) on page 2-12-1 for application information.

Airbus

website: <http://www.airbus.com/home/>

Boeing (includes McDonald Douglas aircraft)

website: <http://www.boeing.com/>

T409-a Aircraft (cargo holds only)

Pest: *Trogoderma granarium* (khapra beetle)

Treatment: T409-a—General surface, perimeter, spot, mist, or crack and crevice

Changes to Table 5-5-10 are effective immediately under authorization of 7 CFR 305.3(b) and are subject to change pending notice and public comment:

- ◆ Add β -Cyfluthrin and Cyfluthrin

Table 5-5-10 T409-a Chemical Alternatives

Active Ingredient ¹	Examples of Trade Names and EPA Registration Numbers (list not all inclusive) ²
β -Cyfluthrin 10,11.8, 20, 24.3, 80% a.i.	Tempo® 1 (#432-1304); Tempo® 10 WP (#432-1305); Tempo® Ultra SC (#432-1363); Tempo® SC Ultra Premise spray (#11556-124); Tempo® Ultra WSP (#432-1377); Tempo® Ultra WP (#432-1304)
Cyfluthrin 6, 20, 24.4% a.i.	Cy-Kick® CS (#499-304); OPTEM® PT 600 ME (#499-304); TC 62 (#499-489); Tempo® 2 (432-1299); Tempo® 20 WSP (#432-1301); Tempo® 20 WP (#432-1302)
Deltamethrin 4.75% a.i.	Suspend SC, K-Othrine® SC (#432-763, D-FENSE SC, Delta SC (#53883-276)

- 1 Apply at the highest rate allowed for the site on the label (active ingredient = a.i.) Follow application instructions on the label.
- 2 No endorsement is intended of the particular items listed and no discrimination is intended toward those products or companies that may not be listed. Use other formulations provided the application method, site, and rate are listed on the label.

T409-b Aircraft

Pest: Hitchhiking insect pests, except khapra beetle

Two alternative treatments—T409-b-1 and T409-b-3

NOTICE

No endorsement is intended of the particular items listed and no discrimination is intended toward those products or companies that may not be listed. Use other formulations provided the application method, site, and rate are listed on the label.

CAUTION

Do **not** subject these chemicals to extreme temperatures.

The aircraft volumes and aerosol calculations in [Table 5-5-11](#) through [Table 5-5-33](#) represent standard configurations of aircraft and are provided for convenience only; always follow the label and verify your calculations. Check with the captain or contact aircraft manufacturers to determine if the aircraft has been modified from the standard configuration and determine the actual volume, if needed.

If the aircraft you are treating is **not** listed, use the formula in [Figure 2-12-1](#) on page [2-12-2](#) to calculate the spray time.

T409-b-1 Aircraft

Treatment: T409-b-1—d-phenothrin aerosol (10 percent) (EPA reg# 10308-21)

10% d-phenothrin is **not** approved for use in California, **except** in Federal installations such as military airports.

Application Rate (g/1000 ft ³)	Spray Rate (g/sec)	Turn off ventilation system and seal the cargo space for (x) minutes	Ventilate the space for (x) minutes
8	5 ¹	15 minutes	15 - 30

1 To control the spray time within smaller spaces, use the red extender tube on the nozzle of the aerosol can. When the extender tube is used, the spray rate is 2.5 grams per second.

NOTICE

Aerosol disinfestation of U.S. military aircraft **must** conform to requirements in the “Department of Defense Customs and Border Clearance Policies and Procedures” DoD 4500.9 (Defense Transportation Regulation Part V).

T409-b-2 (Placeholder)

This is a placeholder for a future treatment.

T409-b-3 Aircraft

Treatment: T409-b-3—2% d-phenothrin + 2% permethrin (EPA reg# 83795-1—Callington 1-Shot™)

CAUTION

Do **not** apply in the passenger cabin area of the aircraft or when passengers or crew are present.

Application Rate (g/1000 ft ³)	Spray Rate (g/sec)	Turn off ventilation system and seal the cargo space for (x) minutes	Ventilate the space for (x) minutes
40	2	15	30
30 ¹			

¹ The 30 g/1000 ft³ application rate has been added under authorization of 7 CFR 305.3(b) (1) (iii), is effective immediately, and is subject to change pending notice and public comment. (November 2022)

If using the 40 g rate, calculate application time manually using the formula in [Figure 2-12-1](#) on page 2-12-2.

Table 5-5-11 Airbus Industries

Aircraft, Model, and Series	Area	Volume ft ³	Aerosol Calculations		
			1,000 ft ³ Units	T409-b-1 Spray Time in Seconds	T409-b-3 (30 g rate) Cans/Spray Time in Seconds
A300	Cabin	27,000	27.1	43.5	6 cans
	Pit-#1	3,722	3.7	6.0	56 sec
	Pit-#2	1,265	1.3	2.0	20 sec
	Pit-#3	565	0.6	1.0	9 sec
A300-600R (passenger) (long range)	Cabin	Calculate manually	Calculate manually	Calculate manually	Calculate manually
	Forward	1,134	1.1	2.0	17sec
	Aft	1,134	1.1	2.0	17sec
	Bulk	400	0.4	0.5	6 sec
A300-600 (freighter)	Main	9,950	10.0	16.0	2 cans
	Pit-Fwd	1,900	1.9	3.0	29 sec
	Pit-Aft	2,250	2.2	3.5	33 sec
A300-600 (FEDEX)	Main	19,069	19.1	30.5	4 cans
	Pit-Fwd	2,684	2.7	4.5	41 sec
	Pit-Aft	2,154	2.2	3.5	33 sec
	Pit-Back	742	0.7	1.0	11 sec
A300 (convertible)	Main	11,943	11.9	19.0	3 cans
A300B4 (freighter)	Main	9,950	10.0	16.0	2 cans
	Pit-Fwd	1,900	1.9	3.0	29 sec
	Pit-Aft	1,850	1.9	3.0	29 sec
A310 (freighter)	Main	7,950	8.0	13.0	2 cans
	Pit-Fwd	1,260	1.3	2.0	20 sec
	Pit-Aft	1,550	1.6	2.5	24 sec
A310 (FEDEX)	Main	14,650	14.7	23.5	3 cans
	Pit-Fwd	1,942	1.9	3.0	29 sec
	Pit-Aft	1,271	1.3	2.0	20 sec
	Pit-Back	742	0.7	1.0	11 sec
A320-200 (passenger)	N/A	982	0.9	1.5	14 sec

Table 5-5-12 Antonov

Aircraft, Model, and Series	Area	Volume ft ³	Aerosol Calculations		
			1,000 ft ³ Units	T409-b-1 Spray Time in Seconds	T409-b-3 (30 g rate) Cans/Spray Time in Seconds
AN 124 and 126	N/A	26,485	26.5	42.5	6 cans

Treatment Schedules T400 - Schedules for Miscellaneous Products

T409-b-3 Aircraft

Table 5-5-13 ATR

Aircraft, Model, and Series	Area	Volume ft ³	Aerosol Calculations		
			1,000 ft ³ Units	T409-b-1 Spray Time in Seconds	T409-b-3 (30 g rate) Cans/Spray Time in Seconds
ATR 42 (CTO) (Container Transport Option)	Bulk	890	0.9	1.5	14 sec
ATR 72 (CTO)	Bulk	1,285	1.3	2.0	20 sec

Table 5-5-14 BAC (British Aircraft Corp.)

Aircraft, Model, and Series	Area	Volume ft ³	Aerosol Calculations		
			1,000 ft ³ Units	T409-b-1 Spray Time in Seconds	T409-b-3 (30 g rate) Cans/Spray Time in Seconds
11-200, 300, and 400	Cabin	4,056	4.1	6.5	62 sec
	Pit-Fwd	380	0.4	0.5	6 sec
	Pit-Aft	154	0.2	0.5	3 sec
111-500	Cabin	5,094	5.1	8.0	1 can
	Pit-Fwd	451	0.5	1.0	8 sec
	Pit-Aft	260	0.3	0.5	5 sec
VC 10	Cabin	6,750	6.8	11.0	2 cans
	Pit-Fwd	744	0.7	1.0	11 sec
	Pit-Aft	820	0.8	1.5	12 sec
Super VC 10	Cabin	7,850	7.9	12.5	2 cans
	Pit-Fwd	744	0.7	1.0	11 sec
	Pit-Aft	820	0.8	1.5	12 sec

Table 5-5-15 BAC (Aerospatale)

Aircraft, Model, and Series	Area	Volume ft ³	Aerosol Calculations		
			1,000 ft ³ Units	T409-b-1 Spray Time in Seconds	T409-b-3 (30 g rate) Cans/Spray Time in Seconds
Concorde	Cabin	5,100	5.1	8.0	1 can
	Pit-Fwd	241	0.2	0.5	8 sec
	Pit-Aft	468	0.5	1.0	15 sec

Table 5-5-16 Boeing

Aircraft, Model, and Series	Area	Volume ft ³	Aerosol Calculations		
			1,000 ft ³ Units	T409-b-1 Spray Time in Seconds	T409-b-3 (30 g rate) Cans/Spray Time in Seconds
707-120, 120B, and 220	Cabin	7,484	7.5	12.0	2 cans
	Pit-Fwd	755	0.8	1.5	12 secs
	Pit-Aft	910	0.9	1.5	14 secs
	Fl. Deck	451	0.5	1.0	8 secs
707-320C	Bulk	7,548	7.5	12.0	2 cans
707-320, 420	Cabin	8,074	8.0	13.0	2 cans
	Pit-Fwd	870	0.9	1.5	14 sec
	Pit-Aft	905	0.9	1.5	14 sec
	Fl. Deck	451	0.5	1.0	8 sec
720	Cabin	6,860	6.9	11.0	2 cans
	Pit-Fwd	688	0.7	1.0	11 sec
	Pit-Aft	690	0.7	1.0	11 sec
	Fl. Deck	451	0.5	1.0	8 sec
727-100C	Bulk	4,168	4.2	7.0	63 sec
727-100 (passenger)	Cabin	4,560	4.6	7.5	1 can
	Pit-Fwd	900	0.9	1.5	14 sec
	Pit-Aft	425	0.4	0.5	6 sec
	Fl. Deck	451	0.5	1.0	8 sec
727-200C	Bulk	8,032	8.0	13.0	2 cans
727-200 (passenger)	Cabin	6,561	6.6	10.5	2 cans
	Pit-Fwd	690	0.7	1.0	11 sec
	Pit-Aft	760	0.8	1.5	12 sec
	Fl. Deck	451	0.5	1.0	8 sec
737-100	Cabin	4,636	4.6	7.5	1 can
	Pit-Fwd	280	0.3	0.5	5 sec
	Pit-Aft	406	0.4	0.5	6 sec
737-200 (passenger)	Cabin	4,636	4.6	7.5	1 can
	Pit-Fwd	370	0.4	0.5	6 sec
	Pit-Aft	505	0.5	1.0	8 sec
737-200C	Bulk	3,602	3.6	6.0	54 secs
737-300	Cabin	4,900	4.9	8.0	1 can
	Pit-Fwd	425	0.4	1.0	6 sec
	Pit-Aft	650	0.7	1.0	11 sec
	Fl. Deck	225	0.3	0.5	5 sec
737-400	Cabin	5,600	5.6	9.0	2 cans
	Pit-Fwd	600	0.6	1.0	9 sec
	Pit-Aft	770	0.8	1.5	12 sec
	Fl. Deck	225	0.2	0.5	3 sec
737-500	Cabin	4,340	4.3	7.0	65 secs
	Pit-Fwd	290	0.3	0.5	5 sec
	Pit-Aft	535	0.5	1.0	8 sec
	Fl. Deck	255	0.3	0.5	5 sec
747 Combi	—	6,886	6.9	11.0	2 cans

Treatment Schedules T400 - Schedules for Miscellaneous Products

T409-b-3 Aircraft

Table 5-5-16 Boeing (continued)

Aircraft, Model, and Series	Area	Volume ft ³	Aerosol Calculations		
			1,000 ft ³ Units	T409-b-1 Spray Time in Seconds	T409-b-3 (30 g rate) Cans/Spray Time in Seconds
747F	—	22,952	23.0	37.0	5 cans
747-100, 200	Cabin	27,650	27.7	44.5	6 cans
	Pit-Fwd	3,485	3.5	6.0	53 sec
	Pit-Aft	3,015	3.0	5.0	45 sec
	Fl. Deck	920	0.9	1.5	14 sec
	U. Deck	1,370	1.4	2.0	21 sec
	Belly	1,000	1.0	1.5	15 sec
747-300, 400	Cabin	27,650	27.7	44.5	6 cans
	Pit-Fwd	3,485	3.5	5.5	53 sec
	Pit-Aft	3,015	3.0	5.0	45 sec
	Fl. Deck	920	0.9	1.5	14 sec
	U. Deck	2,800	2.8	4.5	42 sec
	Belly	1,000	1.0	1.5	15 sec
757-200 (passenger)	Pit-Fwd	652	0.6	1.0	9 sec
	Pit-Aft	1,086	1.1	2.0	17 sec
757-200PF	Bulk	8,405	8.4	13.5	2 cans
767-200	Main	14,255	14.3	23.0	3 cans
	Pit-Fwd	1,470	1.5	2.5	23 sec
	Pit-Aft	1,470	1.5	2.5	23 sec
767-300 (passenger)	Cabin	10,497	10.5	17.0	2 cans
	Pit-Fwd	1,920	1.9	3.0	29 sec
	Pit-Aft	1,680	1.7	2.5	26 sec
	Aft+Bulk	430	0.4	0.5	6 sec
777-200	Cabin	20,700	20.7	33.0	5 cans
	Pit-Fwd	280	0.3	0.5	5 sec
	Pit-Aft	4,630	4.6	7.5	1 can
	Aft+Bulk	4,220	4.2	6.5	63 sec

Table 5-5-17 Canadair

Aircraft, Model, and Series	Area	Volume ft ³	Aerosol Calculations		
			1,000 ft ³ Units	T409-b-1 Spray Time in Seconds	T409-b-3 (30 g rate) Cans/Spray Time in Seconds
CL-44	Bulk	6,235	6.2	10.0	2 cans
CL-440	Bulk	13,798	13.8	22.0	3 cans

Table 5-5-18 Casa

Aircraft, Model, and Series	Area	Volume ft ³	Aerosol Calculations		
			1,000 ft ³ Units	T409-b-1 Spray Time in Seconds	T409-b-3 (30 g rate) Cans/Spray Time in Seconds
C-212	N/A	777	0.8	10.0	12 sec
ATR 72 (CTO)	N/A	1,528	1.5	22.0	23 sec

Table 5-5-19 Cessna

Aircraft, Model, and Series	Area	Volume ft ³	Aerosol Calculations		
			1,000 ft ³ Units	T409-b-1 Spray Time in Seconds	T409-b-3 (30 g rate) Cans/Spray Time in Seconds
Caravan	N/A	452	0.5	1.0	8 sec

Table 5-5-20 Convair

Aircraft, Model, and Series	Area	Volume ft ³	Aerosol Calculations		
			1,000 ft ³ Units	T409-b-1 Spray Time in Seconds	T409-b-3 (30 g rate) Cans/Spray Time in Seconds
240	Cabin	1,650	1.7	2.5	26 sec
	Pit-Fwd	193	0.2	0.5	3 sec
	Belly	88	0.1	— ¹	2 sec
340 & 44-	Cabin	18.16	1.8	3.0	27 sec
	Pit-Fwd	158	0.2	0.5	3 sec
	Pit-Aft	193	0.2	0.5	3sec
	Belly	78	0.1	— ¹	2 sec
880 & 800M	Cabin	5,802	5.8	9.5	2 cans
	Pit-Fwd	415	0.4	0.5	6 sec
	Pit-Aft	488	0.5	1.0	8 sec
990	Cabin	6,336	6.3	10.0	2 cans
	Pit-Fwd	488	0.5	1.0	8 sec
	Pit-Aft	497	0.5	1.0	8 sec

1 In these small volume spaces, use the extender and calculate the application time using a rate of 2.5 grams per second. At a rate of 2.5 grams per second, the following table will give the spray time:

1,000 ft ³ Units	Spray Time in Seconds
0.10.5	
0.20.5	
0.31.0	
0.41.5	

Table 5-5-21 de Havilland

Aircraft, Model, and Series	Area	Volume ft ³	Aerosol Calculations		
			1,000 ft ³ Units	T409-b-1 Spray Time in Seconds	T409-b-3 (30 g rate) Cans/Spray Time in Seconds
Dash 7, Series 100 (all cargo)	N/A	240	0.2	0.5	3 sec
DHC-6 Twin Otter, Series 300 (cargo version)	Fwd	38	0.1	__1	2 sec
	Aft	38	0.1	__1	2 sec
	Bulk	384	0.4	0.5	6 sec
Dash 7, Series 100, Combi (50 passengers)	N/A	240	0.2	0.5	3 sec
Dash 7, Series 100, Combi (18 passengers)	N/A	240	0.2	0.5	3 sec
Dash 8, Series 300, Combi (49 passengers)	N/A	400	0.4	0.5	6 sec
Dash 8, Series 100, Combi (37 passengers)	N/A	300	0.3	0.5	5 sec
Dash 8, Series 100, Combi (20 passengers)	N/A	775	0.8	1.5	12 sec

1 In these small volume spaces, use the extender and calculate the application time using a rate of 2.5 grams per second. At a rate of 2.5 grams per second, the following table will give the spray time:

<u>1,000 ft³ Units</u>	<u>Spray Time in Seconds</u>
0.10.5	
0.20.5	
0.31.0	
0.41.5	

Table 5-5-22 Dornier

Aircraft, Model, and Series	Area	Volume ft ³	Aerosol Calculations		
			1,000 ft ³ Units	T409-b-1 Spray Time in Seconds	T409-b-3 (30 g rate) Cans/Spray Time in Seconds
228-212	N/A	642	0.6	1.0	9 sec

Table 5-5-23 Embraer

Aircraft, Model, and Series	Area	Volume ft ³	Aerosol Calculations		
			1,000 ft ³ Units	T409-b-1 Spray Time in Seconds	T409-b-3 (30 g rate) Cans/Spray Time in Seconds
EMB-120 Brasilia	N/A	1,193	1.2	2.0	18 sec
EMB-110 Brasilia	N/A	523	0.5	1.0	8 sec

Table 5-5-24 Fairchild

Aircraft, Model, and Series	Area	Volume ft ³	Aerosol Calculations		
			1,000 ft ³ Units	T409-b-1 Spray Time in Seconds	T409-b-3 (30 g rate) Cans/Spray Time in Seconds
Expediter	N/A	580	0.6	1.0	9 sec
Metro II & IIA	N/A	580	0.6	1.0	9 sec
F27	Cabin Pit	2,900 192	2.9 0.2	4.5 0.5	44 sec 3 sec
FH11227	Cabin Pit	3,200 192	3.2 0.2	5.0 0.5	48 sec 3 sec

Table 5-5-25 Fokker

Aircraft, Model, and Series	Area	Volume ft ³	Aerosol Calculations		
			1,000 ft ³ Units	T409-b-1 Spray Time in Seconds	T409-b-3 (30 g rate) Cans/Spray Time in Seconds
F27	N/A	198	0.2	0.5	3 sec
F28	N/A	290	0.3	0.5	5 sec
F100C	Bulk	2,070	2.0	3.0	30 sec

Treatment Schedules T400 - Schedules for Miscellaneous Products

T409-b-3 Aircraft

Table 5-5-26 Lockheed

Aircraft, Model, and Series	Area	Volume ft ³	Aerosol Calculations		
			1,000 ft ³ Units	T409-b-1 Spray Time in Seconds	T409-b-3 (30 g rate) Cans/Spray Time in Seconds
Electra	Cabin	5,160	5.2	8.5	1 can
	Pit-Fwd	254	0.3	0.5	5 sec
	Pit-Aft	274	0.3	0.5	5sec
L1011 (100) (200) (250)	Cabin	23,100	23.1	37.0	5 cans
	Pit-Fwd	1,600	1.6	2.5	24 sec
	Pit-Ctr	1,600	1.6	2.5	24sec
	Pit-Aft	700	0.7	1.0	11 sec
	Galley	1,380	1.4	2.0	21 sec
L-1011-1	Cargo Holds	3,900	3.9	6.0	59 secs
L-100-30	N/A	6,057	6.1	10.0	2 cans

Table 5-5-27 McDonnell Douglas

Aircraft, Model, and Series	Area	Volume ft ³	Aerosol Calculations		
			1,000 ft ³ Units	T409-b-1 Spray Time in Seconds	T409-b-3 (30 g rate) Cans/Spray Time in Seconds
DC-3	Bulk	1,300	1.3	2.0	20 sec
DC-6 (cargo)	Bulk	3,354	3.4	5.5	51 sec
DC-6 (passenger)	Cabin	4,332	1.3	7.0	20 sec
	Pit-Fwd	200	0.2	0.5	3 sec
	Pit-Aft	173	0.2	0.5	3sec
DC-6A	Cabin	4,375	4.4	7.0	66 secs
	Pit-Fwd	267	0.3	0.5	5 sec
	Pit-Aft	300	0.3	0.5	5 sec
DC-6B	Cabin	4,375	4.4	7.0	66 secs
	Pit-Fwd	276	0.3	0.5	5 sec
	Pit-Aft	242	0.2	0.5	3 sec
DC-7B	Cabin	4,612	4.6	7.0	1 can
	Pit-Fwd	267	0.3	0.5	5 sec
	Pit-Aft	364	0.4	0.5	6 sec
DC-7C	Cabin	4,778	4.8	7.5	1 can
	Pit-Fwd	312	0.3	0.5	5 sec
	Pit-Aft	339	0.3	0.5	5 sec
DC-8-50	Cabin	12,911	12.9	20.5	3 cans
	Pit-Fwd	690	0.7	1.0	11 sec
	Pit-Aft	700	0.7	1.0	11 sec
DC-8-54F	Main	5,984	6.0	9.5	2 cans
	Pit-Fwd	690	0.7	1.0	11 sec
	Pit-Aft	700	0.7	1.0	11 sec

Table 5-5-27 McDonnell Douglas (continued)

Aircraft, Model, and Series	Area	Volume ft ³	Aerosol Calculations		
			1,000 ft ³ Units	T409-b-1-Spray Time in Seconds	T409-b-3 (30 g rate) Cans/Spray Time in Seconds
DC-8-55F	Main	5,878	5.9	9.5	2 cans
	Pit-Fwd	690	0.7	1.0	11 sec
	Pit-Aft	700	0.7	1.0	11 sec
DC-8-61 & 63	Cabin	15,955	16.0	25.5	4 cans
	Pit-Fwd	1,290	1.3	2.0	20 sec
	Pit-Aft	1,210	1.2	2.0	18 sec
DC-8-62	Cabin	13,739	13.7	22.0	3 cans
	Pit-Fwd	799	0.8	1.5	12 sec
	Pit-Aft	816	0.8	1.5	12 sec
DC-8-62CF	Main	6,442	6.4	10.0	2 cans
	Pit-Fwd	800	0.8	1.5	12 sec
	Pit-Aft	815	0.8	1.5	12 sec
DC-8-63F and DC-8-73F	Main	10,350	10.4	16.5	2 cans
	Pit-Fwd	1,290	1.3	2.0	20 sec
	Pit-Aft	1,210	1.2	2.0	18 sec
DC-8-71CF	Main	8,148	8.1	13.0	2 cans
	Pit-Fwd	1,290	1.3	2.0	20 sec
	Pit-Aft	1,210	1.2	2.0	18 sec
DC-8-61CF & 71-CF	Main	15,472	15.5	25.0	3 cans
	Pit-Fwd	1,290	1.3	2.0	20 sec
	Pit-Aft	1,210	1.2	2.0	18 sec
DC-9-10	Cabin	4,056	4.1	6.5	62 sec
	Pit-Fwd	1,000	1.0	1.5	15 sec
	Pit-Aft	619	0.6	1.0	9 sec
DC-9-10AF	Main	2,386	2.4	4.0	36 sec
	Pit-Fwd	373	0.4	0.5	6 sec
	Pit-Aft	327	0.3	0.5	5 sec
DC-9-30	Cabin	5,094	5.1	8.0	1 can
	Pit-Fwd	1,386	1.4	2.0	21 sec
	Pit-Aft	832	0.8	1.5	12 sec
DC-9-32AF	Main	3,300	3.3	5.5	50 sec
	Pit-Fwd	562	0.6	1.0	9 sec
	Pit-Aft	333	0.3	0.5	5 sec
DC-9-33CF	Main	2,944	2.9	4.5	44 sec
	Pit-Fwd	562	0.6	1.0	9 sec
	Pit-Aft	333	0.3	0.5	5 sec
DC-40	Cabin	5,535	5.5	9.0	1 can
	Pit-Fwd	1,290	1.3	2.0	20 sec
	Pit-Aft	1,040	1.0	1.5	15 sec

Treatment Schedules T400 - Schedules for Miscellaneous Products

T409-b-3 Aircraft

Table 5-5-27 McDonnell Douglas (continued)

Aircraft, Model, and Series	Area	Volume ft ³	Aerosol Calculations		
			1,000 ft ³ Units	T409-b-1-Spray Time in Seconds	T409-b-3 (30 g rate) Cans/Spray Time in Seconds
DC-10-10CF & 10F, also DC-10-30CF & 30F	Main	12,236	12.2	19.5	3 cans
	Pit-Fwd	3,020	3.0	5.0	45 sec
	Pit-Ctr	1,935	1.9	3.0	29 sec
	Pit-Aft	510	0.5	1.0	8 sec
	Fl. Deck	400	0.4	0.5	6 sec
MD8-61/63	Main	11,173	11.2	18.0	3 cans
	Pit-Fwd	1,290	1.3	2.0	20 sec
	Pit-Aft	1,210	1.2	2.0	18 sec
MD8-62	Main	8,862	8.9	14.0	2 cans
	Pit-Fwd	800	0.8	1.5	12 sec
	Pit-Aft	815	0.8	1.5	12 sec
MD9-10	Main	3,582	3.6	6.0	54 sec
	Pit-Fwd	393	0.4	0.5	6 sec
	Pit-Aft	254	0.3	0.5	5sec
MD9-30	Main	4,525	4.5	7.0	68 sec
	Pit-Fwd	562	0.6	1.0	9 sec
	Pit-Aft	333	0.3	0.5	5 sec
MD9-40	Main	4,926	4.9	8.0	74 sec
	Pit-Fwd	618	0.6	1.0	9 sec
	Pit-Aft	350	0.4	0.5	6 sec
MD-11-F	Main Deck	15,530	15.5	25.0	3 cans
	Lower Deck	4,976	5.0	8.0	1 can
MD-11 Combi	Main	5,822	5.8	9.5	2 cans
	Pit-Fwd	3,655	3.7	6.0	56 sec
	Pit-Ctr	2,685	2.7	4.5	41 sec
	Pit-Aft	510	0.5	1.0	8 sec
MD-80 JT8D-217	Lower Hold	1,253	1.3	2.0	20 sec
MD-80 JT8D-219	Lower Hold	1,013	1.0	1.5	15 sec
MD-81 & 82	Cargo	1,253	1.3	2.0	20 sec
MD-83	Cargo	1,013	1.0	1.5	15 sec
MD-87	Cargo	938	0.9	1.5	14 sec
		or 697	0.7	1.0	11 sec
MD-88	Cargo	1,013	1.0	1.5	15 sec
		or 1,253	1.3	2.0	20 sec

Table 5-5-28 SAAB

Aircraft, Model, and Series	Area	Volume ft ³	Aerosol Calculations		
			1,000 ft ³ Units	T409-b-1 Spray Time in Seconds	T409-b-3 (30 g rate) Cans/Spray Time in Seconds
340 B/QC	N/A	1,303	1.3	2.0	20 sec

Table 5-5-29 Shorts

Aircraft, Model, and Series	Area	Volume ft ³	Aerosol Calculations		
			1,000 ft ³ Units	T409-b-1 Spray Time in Seconds	T409-b-3 (30 g rate) Cans/Spray Time in Seconds
330	N/A	1,230	1.2	2.0	18 sec
360 and 360-F	N/A	1,450	1.5	2.5	23 sec

Table 5-5-30 Sidely

Aircraft, Model, and Series	Area	Volume ft ³	Aerosol Calculations		
			1,000 ft ³ Units	T409-b-1 Spray Time in Seconds	T409-b-3 (30 g rate) Cans/Spray Time in Seconds
Carvelle	Cabin	5,600	5.6	9.0	2 cans
	Pit-Fwd	258	0.3	0.5	5 sec
	Pit-Aft	116	0.1	— ¹	2 sec

- 1 In these small volume spaces, use the extender and calculate the application time using a rate of 2.5 grams per second. At a rate of 2.5 grams per second, the following table will give the spray time:

1,000 ft³ Units Spray Time in Seconds

0.10.5

0.20.5

0.31.0

0.41.5

Table 5-5-31 Tupolev

Aircraft, Model, and Series	Area	Volume ft ³	Aerosol Calculations		
			1,000 ft ³ Units	T409-b-1 Spray Time in Seconds	T409-b-3 (30 g rate) Cans/Spray Time in Seconds
TU-154	Bulk	5,000	5.0	8.0	1 can

Treatment Schedules T400 - Schedules for Miscellaneous Products

T409-b-3 Aircraft

Table 5-5-32 Vickers

Aircraft, Model, and Series	Area	Volume ft ³	Aerosol Calculations		
			1,000 ft ³ Units	T409-b-1 Spray Time in Seconds	T409-b-3 (30 g rate) Cans/Spray Time in Seconds
Merchantman	Bulk	5,040	5.0	8.0	1 can
Viscount	Bulk	3,000	3.0	5.0	45 sec

Table 5-5-33 Military Aircraft

Aircraft, Model, and Series	Area	Volume ft ³	Aerosol Calculations		
			1,000 ft ³ Units	Spray Time in Seconds	T409-b-3 (30 g rate) Cans/Spray Time in Seconds
C-5A	Main	46,651	46.7	74.5	10 cans
	U. Deck	6,147	6.1	10.0	2 cans
	Fwd & Fl. Deck	5,147	5.1	8.0	1 can
	U. Floor	6,294	6.3	10.0	2 cans
C-17	Main	20,875	20.9	33.5	5 cans
C-26	Cabin	500	0.5	1.0	8 sec
	Pit	198	0.2	0.5	3 sec
C-130	Main	8,340	8.3	13.5	2 cans
C-130 LG382		4,737	4.7	7.5	1 can
C-130 LG385G		6,057	6.1	10.0	2 cans
C-135	Cabin	6,000	6.0	9.5	2 cans
C-141	Main	12,000	12.0	19.0	3 cans
C-141B	Main	13,701	13.7	22.0	3 cans
KC-10	Cabin	4,056	4.1	6.5	62 secs
	Pit-Fwd	1,000	1.0	1.5	15 sec
	Pit-Aft	619	0.6	1.0	9 sec

T410—Tick Infestations

T410 Nonplant Articles (i.e., Bat Guano, Fence Posts, etc.)

Pest: Ticks

Treatment: Use T310 schedules, Tick-infested materials (nonfood)

T411—Ant Infestations—Nonplant Products

Pest: Ants

Treatment: T411—MB at NAP

Temperature (°F)	Dosage Rate (lb/1,000 ft ³)	Minimum Concentration Readings (ounces) At:				
		0.5 hr	2.5 hrs	3 hrs	3.5 hrs	4 hrs
90-96	2.0	24	16	–	–	–
80-89	2.5	30	24	–	–	–
70-79	3.0	36	24	–	–	–
60-69	3.0	36	–	24	–	–
50-59	3.0	36	–	–	24	–
40-49	3.0	36	–	–	–	24

T412—Noxious Weed Seeds (Devitalization Treatment)

T412-a *Guizotia abyssinica* (Niger Seed)

Pest: Weed seeds of the following genera:

Asphodelus fistulosus (onionweed)
Digitaria spp. (includes African couchgrass)
Oryza spp. (red rice)
Paspalum scrobiculatum (Kodo-millet)
Prosopis spp. (includes mesquites)
Solanum viarum (tropical soda apple)
Striga spp. (witchweed)
Urochloa panicoides (liver-seed grass)

Treatment: T412-a—Dry heat treatment at 248 °F (120 °C) for 15 minutes

NOTICE

Do **not** start counting time until the entire mass reaches the required temperature.

T412-b-1 Noxious Weed Seeds (Devitalization Treatment)

Pest: *Cuscuta* spp.

Treatment: T412-b-1—Dry heat—commodity heated to 212 °F (100 °C) for 15 minutes

T412-b-2 Noxious Weed Seeds (Devitalization Treatment)

Pest: *Cuscuta* spp.

Treatment: T412-b-2—Steam heat—commodity heated to 212 °F (100 °C) for 15 minutes

T412-b-3 Deleted

T413—Brassware From Mumbai (Bombay), India

T413-a Brassware From Mumbai (Bombay), India

Pest: *Trogoderma granarium* (khapra beetle)

Treatment: T413-a—MB at NAP—tarpaulin or chamber

Temperature (°F)	Dosage Rate (lb/1,000 ft ³)	Minimum Concentration Readings (ounces) At:		
		0.5 hr	2hrs	12 hrs
90 and above	2.5	30	20	15
80-89	3.5	42	30	20
70-79	4.5	54	40	25
60-69 ¹	6.0	72	50	30
50-59	7.5	90	60	35
40-49 ²	9.0	108	70	40

1 Use MB 100 gas at 60 °F or above.

2 Use MB "Q" gas at 40 °F or above.

NOTICE

When both woodborers and khapra beetles are involved, use schedule [T404-d Wood Products Including Containers](#) on page 5-5-24.

T413-b Brassware From Mumbai (Bombay), India

Treatment: T413-b—MB in 26" vacuum

Temperature (°F)	Dosage Rate (lb/1,000 ft ³)	Exposure Period (hours)
60 and above ¹	8.0	3
40-59 ²	9.0	3

1 Use MB 100 gas at 60 °F or above.

2 Use MB "Q" gas at 40 °F or above.

NOTICE

Load limit is 75 percent of chamber volume.

T414—Inanimate, Nonfood Articles with Gypsy Moth Egg Masses

T414 Inanimate, Nonfood Articles with Gypsy Moth Egg Masses

Pest: Gypsy moth (*Lymantria dispar*) egg masses

Treatment: T414—MB at NAP—tarpaulin or chamber

Temperature (°F)	Dosage Rate (lb/1,000 ft ³)	Minimum Concentration Readings (ounces) At:				
		0.5 hr	4 hrs	8 hrs	12 hrs	16 hrs
50 and above	3.5	42	28	–	–	–
	2.5	30	20	14	–	–
	2.0	24	16	12	12	10
40-49	4.5	54	36	–	–	–
	3.25	38	26	18	–	–
	2.25	30	20	14	14	12

NOTICE

Use T414 to treat articles such as outdoor household articles, quarry products, lumber, logs, and timber products.

T415—Garbage and Quarantine Material Interceptions for Destruction

Three alternative treatments are approved. The treatments can be used for commodity destruction. Refer to the Glossary for the definitions of quarantine material interceptions (QMI) and garbage.

Authorized users must refer to the APHIS *Regulated Garbage Program Manual* for guidance on handling regulated garbage.

T415-a Garbage and Quarantine Material Interceptions for Destruction

Pest: Insect pests and pathogens

Treatment: T415-a—Heat treatment—Incinerate to ash

NOTICE

Caterers under compliance agreement incinerating QMI and garbage **must** comply with the following conditions:

- ◆ Incinerator **must** be capable of reducing the material to ash.
- ◆ Incinerator **must** be maintained adequately to assure continued operation.

T415-b Garbage and Quarantine Material Interceptions for Destruction

Pest: Insect pests and pathogens

Treatment: T415-b—Dry heat or steam—commonly heated to internal temperature of 212 °F (100 °C) for 30 minutes followed by burial in a landfill.

NOTICE

Caterers under compliance agreement sterilizing QMI and garbage **must** comply with the following conditions:

- ◆ The sterilizer **must** be capable of heating the material to an internal temperature of 212 °F and maintaining it at that temperature for a minimum of 30 minutes.
- ◆ Reevaluate and adjust the sterilization cycle twice a year using a thermocouple to recalibrate the temperature recording device. Adjusting the sterilization cycle semiannually will assure that all material processed is heated to a minimum internal temperature of 212 °F for at least 30 minutes, and that the temperature recording device accurately reflects the internal temperature of the sterilizer.

NOTICE

Observe all reevaluations and adjustments.

- ◆ The operator is to date and initial time/temperature records for each batch of material sterilized. The supervisor is to review and sign each time/temperature record. The facility **must** retain records for 6 months for review by PPQ.
- ◆ Clean the drain in the bottom of the sterilizer between each cycle to assure proper heat circulation.

T415-c Garbage and Quarantine Material Interceptions for Destruction

Pest: Insect pests and plant pathogens

Treatment: T415-c—Grinding and discharge into an approved sewage system

CAUTION

Do **not** use T415-c for:

- ◆ Animal byproducts
- ◆ Animal products
- ◆ Soil

NOTICE

Use T415-c to grind fleshy, non-fibrous fruits and vegetables as long as the fruit or vegetable does not have a seed that would prevent grinding (e.g. mango). Grinding and discharging is allowed into an approved sewage system. An approved sewage system is designed and operated in such a way as to preclude the discharge of sewage effluents onto land surfaces or into lagoons or other stationary waters, is adequate to prevent the dissemination of plant pests, and is certified by an appropriate government official as currently complying with the applicable laws for environmental protection.

T416—Goatskins, Lambskins, Sheepskins (Skins and Hides)

Three alternative treatments

NOTICE

Fur, horsehair articles, and leather goods (skins and hides) may cause off-odors that may be unacceptable when exposed to MB.

NOTICE

Do not fumigate items known to be sorptive or items whose sorptive properties are unknown in NAP chambers unless gas concentration readings are taken.

T416-a-1 Goatskins, Lambskins, Sheepskins (Skins and Hides)

Pest: *Trogoderma granarium* (khapra beetle)

Treatment: T416-a-1—MB (“Q” gas only) at NAP—tarpaulin

Temperature (°F)	Dosage Rate (lb/1,000 ft ³)	Minimum Concentration Readings (ounces) At:		
		0.5 hr	2hrs	12 hrs
90 and above	2.5	30	20	15
80-89	3.5	42	30	20
70-79	4.5	54	40	25
60-69	6.0	72	50	30
50-59	7.5	90	60	35
40-49	9.0	108	70	40

The sorptive rates of commodities vary. When a commodity is known or suspected to be sorptive (see [Sorption](#) on page 2-3-10), take more gas readings than normal. Additional fumigant is added as prescribed in [Adding Gas and Extending Exposure Period to Commodities that are Fumigated Using Treatment Schedules Other Than T101-a-1 or Equivalent \(may include perishables\)](#) on page 2-4-33.

When both woodborers and khapra beetles are involved, use [T404-d Wood Products Including Containers](#) on page 5-5-24.

T416-a-2 Goatskins, Lambskins, Sheepskins (Skins and Hides)

NOTICE

Load limit is 75 percent of chamber volume.

Pest: *Trogoderma granarium* (khapra beetle)

Treatment: T416-a-2—MB (“Q” label gas) in 26” vacuum

Temperature (°F)	Dosage Rate (lb/1,000 ft ³)	Exposure Period (hours)
60 and above	8.0	3
40-59	9.0	3

T416-a-3 Goatskins, Lambskins, Sheepskins (Skins and Hides)

Pest: *Trogoderma granarium* (khapra beetle)

Treatment: T416-a-3—MB (“Q” gas only) in NAP—chamber

Temperature (°F)	Dosage Rate (lb/1,000 ft ³)	Exposure Period (hours)
90-96	2.5	12
80-89	3.5	12
70-79	4.5	12
60-69	6.0	12
50-59	10.0	12
40-49	12.0	12

Amount of Phosphine Liberated by Various Products

Calculate amount of product needed by using the amount of phosphine released as shown in the right column.

Table 5-5-34 Amount of Phosphine Liberated by Various Products

Product	Type	Unit and Weight in Grams	Grams of Phosphine ¹
Degesch Fumi-Cel [®]	MP	1 plate; 117.0	33.0
Degesch Fumi-Strip [®]	MP	16 plates; 1872.0	528.0
Degesch Phostoxin [®]	AP	1 tablet; 3.0	1.0
Degesch Phostoxin [®] Tablet Prepac Rope	AP	1 prepac; 99.0 (strip or rope of 33 tablets)	33.0
Detia	AP	1 tablet; 3.0	1.0
Detia Rotox AP	AP	1 pellet; 0.6	0.2
Detia Gas EX-B	AP	1 bag or sachet; 34.0	11.4
Fumiphos tablets	AP	1 tablet; 3.0	1.0
Fumiphos pellets	AP	1 pellet; 0.6	0.2
Fumiphos bags	AP	1 bag; 34.0	11.0
Fumitoxin [®]	AP	1 tablet; 3.0	1.0
Fumitoxin [®]	AP	1 pellet; 0.6	0.2
Fumitoxin [®]	AP	1 bag; 34.0	11.0
Gastoxin	AP	1 tablet; 3.0	1.0
Gastoxin	AP	1 pellet; 0.6	0.2
"L" Fume	AP	1 pellet; 0.5	0.18
	AP	1 pellet; 0.6	0.22
Phos-Kill	AP	1 tablet; 3.0	1.1
Phos-Kill	AP	1 pellet; 0.6	0.22
Phos-Kill	AP	1 bag; 34.0	12.0

1 Reacts with moisture in the air to yield grams of phosphine.

Treatment Schedules

T500 - Schedules for Plant Pests or Pathogens

Contents

General Schedules

- T501—Infestation of *Chrysomyxa* spp., *Cercospora* spp., and *Phoma chrysanthemi* on Various Commodities **5-6-4**
- T502—Treatment for Infestation of Potato Cyst Nematode on Various Commodities **5-6-6**
- T503—Treatments for Infestations of Downy Mildews and *Physoderma* Diseases of Maize **5-6-7**
- T504—Treatment for Infestation of Flag Smut on Various Commodities **5-6-7**
- T505—Treatment for Infestation of *Chrysomyxa* spp. on Various Commodities **5-6-8**
- T506—Treatment for Infestation of Potato Cyst Nematode on Various Commodities **5-6-8**
- T507—Treatment for Infestation of *Phyllosticta bromeliae*, *Uredo*, and *Septoria gentianae* (Gentian Leaf Spot) on Various Commodities **5-6-10**
- T508—Treatment for Infestation of Rusts on Various Commodities **5-6-10**
- T509—Treatment for Infestation of Various Plant Pests of Camellia and Orchids **5-6-11**
- T510—Treatment for Infestation of Various Corn-Related Diseases **5-6-12**
- T511—Precautionary Treatment for *Xanthomonas axonopodis*, pv. *citri* (Citrus Canker) **5-6-12**
- T512—(Deleted) **5-6-14**
- T513—Treatment for Infestations of *Ascochyta* on Various Commodities **5-6-14**
- T514—Treatment for Infestations of *Xanthomonas albilineans* and *X. vasculorum* **5-6-14**
- T515—Treatment for Infestations of Various Sugarcane-Related Diseases **5-6-15**
- T516—(Deleted) **5-6-16**
- T517—(Deleted) **5-6-16**
- T518—Treatment for Infestations of Various Rice-Related Diseases **5-6-16**
- T519—Treatment for Infestations of Various Rice-Related Diseases **5-6-17**
- T520—Treatment for Infestation of *Verticillium albo-atrum* on Various Commodities **5-6-17**
- T521—Treatment for Infestation of Plant Pathogenic Fungi and Bacteria on Articles Made with Dried Plant Material **5-6-17**

Hot Water Treatments

- T551—Treatment for Infestation of *Globodera rostochiensis* and *G. pallida* (Nematodes) on *Convallaria* (Pips) **5-6-19**
- T552—Treatment for Infestation of *Ditylenchus dipsaci* and *D. destructor* **5-6-19**
- T553—Treatment for Infestations of Nematodes on Various Plant Commodities **5-6-20**
- T554—Treatment for Infestations of *Ditylenchus dipsaci* and *D. destructor* on *Hyacinthus* **5-6-21**
- T555—Treatment for Infestations of *Ditylenchus dipsaci* on *Narcissus* **5-6-21**
- T556—Treatment for Infestations of Root-Knot Nematodes (*Meloidogyne* spp.) on *Calla* **5-6-22**
- T557—Treatment for Infestations of *Meloidogyne* spp. and *Pratylenchus* spp. on *Chrysanthemum* (not including *Pyrethrum*) **5-6-22**
- T558—Treatment for Infestations of *Pratylenchus* Surface Diseases on *Fragaria* (Strawberry) **5-6-22**
- T559—Treatment for Infestations of Foliar Nematodes on *Begonia* and *Oryza* (Paddy Rice) **5-6-22**
- T560—Treatment for Infestations of *Meloidogyne* spp. on *Rosa* **5-6-23**
- T561—Treatment for Infestations of *Cercospora mamaonis* and *Phomopsis carica-papayae* on Papayas **5-6-23**
- T562—(Deleted) **5-6-23**
- T563—(Deleted) **5-6-23**
- T564—Treatment for Infestations of Foliar Nematodes on Various Commodities **5-6-23**
- T565—Treatment for Infestations of Nematodes on Various Commodities **5-6-24**
- T566—Treatment for Infestations of Various Diseases on Broomcorn, Broomcorn Articles, and *Lilium* (Bulbs) **5-6-25**
- T567—Treatment for Infestations of Bulb Nematodes on Various Commodities **5-6-25**
- T568—Treatment for Infestations of Foliar Nematodes on *Senecio* **5-6-25**
- T569—Treatment for Infestations of Foliar Nematodes on *Fragaria* (Strawberry) **5-6-26**
- T570—Treatment for Infestations of Various Diseases on *Acalypha* and *Aconitum* **5-6-26**
- T571—(Deleted) **5-6-26**

The following section lists the recommended treatments or actions to be applied to items or commodities found infected with various diseases, or infested with various plant pests, including nematodes. Commodities may include cut flowers and greenery, propagative plant materials, as well as entire plants. Due to recent restrictions and prohibitions on the use of certain chemicals, every effort has been made to substitute the best alternative

treatment available to us. The diseases and commodities for which these treatments are recommended are listed in the Index to Schedules, and with the following treatment schedules. Ports should endeavor to make post-treatment examinations or arrange to have the consignee or importer submit data concerning the material following the treatment. Ports should forward any information of this nature to:

USDA-APHIS-PPQ-S&T-TMT
Science and Technology, Treatment Mitigation Technology
13601 Old Cutler Road, Bldg. 63
Miami, FL 33158 USA
Phone: 305-278-4877
Fax: 305-278-4898
email: ppqmt@usda.gov

T501—Infestation of *Chrysomyxa* spp., *Cercospora* spp., and *Phoma chrysanthemi* on Various Commodities

T501-1—Azalea

Pest: *Chrysomyxa* spp.

Treatment: T501-1—Remove infected parts and treat all plants of same species in consignment with an EPA-registered copper sulfate, copper sulfate pentahydrate, or copper oxychloride sulfate pesticide product according to label rates and directions.

Regulatory Authority

"4-4-50 Bordeaux" has been replaced with any EPA-registered copper product. Changes are effective immediately under authorization of 7 CFR 305.3((b)(1)(iv)) and are subject to change pending notice and comment. (November 2020)

NOTICE

See alternative treatment [T505-1—Azaleodendron](#) for *Chrysomyxa* spp.

T501-2—Azaleodendron

Pest: *Chrysomyxa* spp.

Treatment: T501-2—Remove infected parts and treat all plants of same species in consignment with an EPA-registered copper sulfate, copper sulfate pentahydrate, or copper oxychloride sulfate pesticide product according to label rates and directions.

Regulatory Authority

"4-4-50 Bordeaux" has been replaced with any EPA-registered copper product. Changes are effective immediately under authorization of 7 CFR 305.3((b)(1)(iv)) and are subject to change pending notice and comment. (November 2020)

NOTICE

See alternative treatment [T505-1—Azaleodendron](#) for *Chrysomyxa* spp.

T501-4—Chrysanthemum

Pest: *Phoma chrysanthemi*

Treatment: T501-4—Remove infected parts and treat all plants of same species in consignment with an EPA-registered copper sulfate, copper sulfate

pentahydrate, or copper oxychloride sulfate pesticide product according to label rates and directions.

Regulatory Authority

"4-4-50 Bordeaux" has been replaced with any EPA-registered copper product. Changes are effective immediately under authorization of 7 CFR 305.3((b)(1)(iv)) and are subject to change pending notice and comment. (November 2020)

T501-5—Christmas Trees

Pest: *Phoma chrysanthemi*

Treatment: T501-5—Remove infected parts and treat all plants of same species in consignment with an EPA-registered copper sulfate, copper sulfate pentahydrate, or copper oxychloride sulfate pesticide product according to label rates and directions.

Regulatory Authority

"4-4-50 Bordeaux" has been replaced with any EPA-registered copper product. Changes are effective immediately under authorization of 7 CFR 305.3((b)(1)(iv)) and are subject to change pending notice and comment. (November 2020)

T501-3—Orchid

Pest: *Cercospora* spp.

Treatment: T501-3—Remove infected parts and treat all plants of same species in consignment with an EPA-registered copper sulfate, copper sulfate pentahydrate, or copper oxychloride sulfate pesticide product according to label rates and directions.

Regulatory Authority

"4-4-50 Bordeaux" has been replaced with any EPA-registered copper product. Changes are effective immediately under authorization of 7 CFR 305.3((b)(1)(iv)) and are subject to change pending notice and comment. (November 2020)

T501-6—Rhododendron

Pest: *Chrysomyxa* spp.

Treatment: T501-6—Remove infected parts and treat all plants of same species in consignment with an EPA-registered copper sulfate, copper sulfate

Treatment Schedules T500 - Schedules for Plant Pests or Pathogens

T502—Treatment for Infestation of Potato Cyst Nematode on Various Commodities

pentahydrate, or copper oxychloride sulfate pesticide product according to label rates and directions.

Regulatory Authority

"4-4-50 Bordeaux" has been replaced with any EPA-registered copper product. Changes are effective immediately under authorization of November CFR 305.3(b)(1)(iv) and are subject to change pending notice and comment. (October 2020)

NOTICE

See alternative treatment [T505-2—Rhododendron](#) for *Chrysomyxa* spp.

T502—Treatment for Infestation of Potato Cyst Nematode on Various Commodities

T502-1—Bags and Bagging Used for Commodities Grown in Soil

Treatment: T502-1—Methyl bromide chamber 26" vacuum

Temperature (°F)	Dosage Rate (lb/1,000 ft ³)	Exposure Period (hours)
40 and above	8.0	16

T502-2—Covers Used for Commodities Grown in Soil

Treatment: T502-2—Methyl bromide—chamber 26" vacuum

Temperature (°F)	Dosage Rate (lb/1,000 ft ³)	Exposure Period (hours)
40 and above	8.0	16

T502-3—Soil

Treatment: T502-3—Methyl bromide—chamber 26" vacuum

Temperature (°F)	Dosage Rate (lb/1,000 ft ³)	Exposure Period (hours)
40 and above	8.0	16

T503—Treatments for Infestations of Downy Mildews and Physoderma Diseases of Maize

T503-1—Bags and Bagging (Used) for Small Grains

Pest: Diseases listed in 7CFR 319.24: Downy mildews and *Physoderma* diseases of maize

Treatment: T503-1-2—Hot water treatment—soak in water slightly below boiling (212 °F) for 1 hour.

Treatment: T503-1-3—Live steam for 10 minutes at 240 °F, NAP. For baled material, live steam at 10 pounds pressure for 20 minutes.

Treatment: T503-1-4—Dry heat at 212 °F for 1 hour. Treat small bales **only**.

T503-2—Covers Used for Small Grains

Pest: Diseases listed in 7CFR 319.24: Downy mildews and *Physoderma* diseases of maize

Treatment: T503-2-2—Hot water treatment—soak in water slightly below boiling (212 °F) for 1 hour.

Treatment: T503-2-3—Live steam for 10 minutes at 240 °F, NAP. For baled material, live steam at 10 pounds pressure for 20 minutes.

Treatment: T503-2-4—Dry heat at 212 °F for 1 hour. Treat small bales **only**.

T504—Treatment for Infestation of Flag Smut on Various Commodities

T504-1—Bags and Bagging (Used) for Small Grains

Pest: Flag smut

Treatment: T504-1-1—Dry heat at 212 °F for 1 hour. Treat small bales **only**.

Treatment: T504-1-2—Steam at 10 pounds pressure at 242 °F (114 °C) for 20 minutes.

T504-2—Covers Used for Wheat

Pest: Flag smut

Treatment: T504-2-1—Dry heat at 212 °F for 1 hour. Treat small bales **only**.

Treatment: T504-2-2—Steam at 10 pounds pressure at 242 °F (114 °C) for 20 minutes.

T505—Treatment for Infestation of *Chrysomyxa* spp. on Various Commodities

T505-1—Azaleodendron

Pest: *Chrysomyxa* spp.

Treatment: T505-1-1—Treat with mancozeb or other approved fungicide of equal effectiveness according to label rates and directions.

Treatment: T505-1-2—See alternative treatment [T501—Infestation of *Chrysomyxa* spp., *Cercospora* spp., and *Phoma chrysanthemi* on Various Commodities](#)

T505-2—Rhododendron

Pest: *Chrysomyxa* spp.

Treatment: T505-2-1—Treat with mancozeb or other approved fungicide of equal effectiveness according to label rates and directions.

Treatment: T505-2-2—See alternative treatment [T501-6—Rhododendron](#)

T506—Treatment for Infestation of Potato Cyst Nematode on Various Commodities

T506-1—Containers

Pest: Potato cyst nematode

Treatment: T506-1-1—MB (“Q” label **only**) in 26” vacuum

Temperature	Dosage Rate (lb/1,000 ft ³)	Exposure Period
40 °F or above	8.0 lbs	16 hrs
	10.5 lbs	12 hrs
	16.0 lbs	8 hrs

Treatment: T506-1-3—High pressure steam. See T506-2-3.

T506-2—Nonplant Articles

Pest: Potato cyst nematode

Treatment: T506-2-1—MB (“Q” label **only**) in 26” vacuum

Temperature	Dosage Rate (lb/1,000 ft ³)	Exposure Period
40 °F or above	8.0 lbs	16 hrs
	10.5 lbs	12 hrs
	16.0 lbs	8 hrs

Treatment: T506-2-3—High pressure steam

Live steam is introduced into a closed chamber containing the material to be treated until the required temperature and pressure are indicated. The temperature/pressure relationship is maintained at or above this point for the required exposure period. The exposure period will depend on the nature of the material, quantity, and its penetrable condition.

For loosely packed materials which permit rapid and complete penetration of steam to all parts of the mass, **no** initial vacuum is needed, but air **must** be released until steam vapor escapes, and exposure at 20 pounds pressure for 10 minutes, 15 pounds for 15 minutes, or 10 pounds for 20 minutes is sufficient.

For tightly packed material, such as soil, special measures are needed to ensure rapid heat penetration to all parts of the material. Soil, if in large containers, **will not** allow adequate treatment under normal sterilization exposure periods.

Quicker penetration of the steam is obtained by first exhausting the air in the chamber to a high vacuum and then introducing live steam until the required positive pressure is reached.

T507—Treatment for Infestation of *Phyllosticta bromeliae*, *Uredo*, and *Septoria gentianae* (Gentian Leaf Spot) on Various Commodities

T507-1—Bromeliads—Deleted

Pest: *Phyllosticta bromeliae*, *Uredo* spp.

Regulatory Authority

Captan is no longer labeled for use on Bromeliads. T507-1 has been removed under authorization of 7 CFR 305.3((b)(1)(iv)) and is subject to change pending notice and comment. Refuse entry, reexport, or destroy the commodity. (November 2020)

Treatment: T507-1—deleted

T507-2—*Gentiana*—Deleted

Pest: *Septoria gentianae*

Regulatory Authority

Captan is no longer labeled for use on *Gentiana*. T507-2 has been removed under authorization of 7 CFR 305.3((b)(1)(iv)) and is subject to change pending notice and comment. Refuse entry, reexport, or destroy the commodity. (November 2020)

Treatment: T507-2—deleted

T508—Treatment for Infestation of Rusts on Various Commodities

T508-1—Orchids (to Florida)

Pest: Rusts

Treatment: T508-1—***For rust-infected consignments to Florida:*** Refuse entry to all infected plants and all other plants of the same species or variety in the consignment.

Regulatory Authority

Captan is no longer labeled for use on orchids. It has been removed under authorization of 7 CFR 305.3((b)(1)(iv)) and is subject to change pending notice and comment. Refuse entry, reexport, or destroy the commodity. (October/November 2020)

For rusts on orchids to states other than Florida, follow the procedures in [T509—Treatment for Infestation of Various Plant Pests of Camellia and Orchids](#).

T509—Treatment for Infestation of Various Plant Pests of Camellia and Orchids

T509-1—Camellia

Pest: *Cylindrosporium camelliae*

Treatment: T509-1-1—**Light infection:** Remove infected leaves and dip or spray plant with an EPA-registered copper sulfate, copper sulfate pentahydrate, or copper oxychloride sulfate pesticide product according to label rates and directions. Dry quickly and thoroughly before release.

Regulatory Authority

"4-4-50 Bordeaux" has been replaced with any EPA-registered copper product. Changes are effective immediately under authorization of 7 CFR 305.3((b)(1)(iv)) and are subject to change pending notice and comment. (November 2020)

Treatment: T509-1-2—**Heavy infection:** Refuse entry.

T509-2—Orchids

Pest:

Hemileia spp.
Leptosphaeria spp.
Mycosphaerella spp.
Opiodothella orchidearum
Phomopsis orchidophilia
Phyllachora spp.
Phyllosticta spp.
Sphenospora spp.
Sphaerodothis spp.
Uredo spp. (except *U. scabies*)

Treatment: T509-2-1—**Light infection:** Remove infected leaves and dip or spray plant with an EPA-registered copper sulfate, copper sulfate pentahydrate, or copper oxychloride sulfate pesticide product according to label rates and directions. Dry quickly and thoroughly before release.

Regulatory Authority

"4-4-50 Bordeaux" has been replaced with any EPA-registered copper product. Changes are effective immediately under authorization of 7 CFR 305.3((b)(1)(iv)) and are subject to change pending notice and comment. (November 2020)

Treatment: T509-2-2—**Heavy infection:** Refuse entry.

T510—Treatment for Infestation of Various Corn-Related Diseases

T510-1—Corn (Seed) (Commercial Lots Not for Propagation)

Pest: Various corn-related diseases

Treatment: T510-1—Live steam from jet or nozzle into loose masses of material until all parts reach 212 °F.

T510-2—Corn (seed) (small lots for propagation but not for food, feed, or oil purposes)

Pest: Various corn-related diseases

Treatment: T510-2—Treat seeds with a dry application of Mancozeb in combination with Captan according to label rates and directions. Disinfect small bags (weighing 60 lbs. or less) with:

- ◆ Dry heat at 212 °F for 1 hour or
 - ◆ Steam at 10 pounds pressure at 240 °F for 20 minutes
-

T511—Precautionary Treatment for *Xanthomonas axonopodis*, pv. *citri* (Citrus Canker)

T511-1—Seeds of *Citrus* spp., *Fortunella* spp., *Clausena lansium* and *Poncirus trifoliata* (and all cultivars, varieties, and hybrids)

Pest: *Xanthomonas axonopodis*, pv. *citri* (citrus canker)

Treatment: T511-1

1. Wash the seed to remove the pulp.
2. Immerse the seeds in water heated to 125 °F (51.6 °F) or higher for 10 minutes.
3. Then, immerse seed in a solution containing 0.525% (5,250 parts per million) sodium hypochlorite for at least 2 minutes.

Regulatory Authority

Changes to sodium hypochlorite concentration and pH are effective immediately under authorization of 7 CFR 305.3((b)(1)(iv)) and are subject to change pending notice and comment. (October 2020)

See [Sodium Hypochlorite \(Bleach\) Treatments](#) on page 2-13-5 for dilution tables and pH adjustment directions. In general, adjust the pH to 5.5 to 7.0 using acetic acid (white vinegar) under a fume hood or in a well-ventilated area, and mix the following dilutions:

- ◆ Using 8.25%, 8.3%, 8.5%, or 8.6% sodium hypochlorite formulations, mix 1 part in 15 parts of water.

4. Drain, dry, and repack near original moisture content.

The use site **must** be listed on the label. To minimize corrosion of surfaces in contact with bleach, thoroughly wash down all work areas.

T511-2—Fruit of *Citrus* spp., *Fortunella* spp., *Clausena lansium* and *Poncirus trifoliata* (and all cultivars, varieties, and hybrids)

Pest: *Xanthomonas axonopodis*, pv. *citri* (citrus canker)

Treatment: T511-2

There are three chemical treatments approved for use **as part of a systems approach at an approved packing house in the exporting country.**

Table 5-6-1 Citrus Canker Chemical Treatments

Chemical Name	Concentration
Sodium hypochlorite	0.02% (200 ppm) (pH=5.5 - 7.0)
Sodium o-phenyl phenate	1.86 - 2.0 % of the total solution
Peroxyacetic acid	85 ppm

Regulatory Authority

Changes to sodium hypochlorite pH are effective immediately under authorization of 7 CFR 305.3((b)(1)(iv)) and are subject to change pending notice and comment. (October 2020)

See [Sodium Hypochlorite \(Bleach\) Treatments](#) on page 2-13-5 for dilution tables and pH adjustment directions. In general, adjust the pH to 5.5 to 7.0 using acetic acid (white vinegar) under a fume hood or in a well-ventilated area, and mix the following dilutions:

- ◆ Using 8.4% sodium hypochlorite formulation, mix 1 part in 419 parts of water.
- ◆ Using 12.5% sodium hypochlorite formulation, mix 1 part in 624 parts of water.

The use site must be listed on the label. To minimize corrosion of surfaces in contact with bleach, thoroughly wash down all work areas.

T512—(Deleted)

T513—Treatment for Infestations of *Ascochyta* on Various Commodities

T513-1—Orchids

Pest: *Ascochyta* spp.

Treatment: T513-1—Defoliate if leaf-borne **only**; refuse entry if pseudo-bulbs infected.

T514—Treatment for Infestations of *Xanthomonas albilineans* and *X. vasculorum*

T514-1—Saccharum (Sugarcane) (Seed pieces)

Pest: *Xanthomonas albilineans* and *X. vasculorum*

Treatment: T514-1—Presoak in water at room temperature for 24 hours, then immerse in water at 122 °F for 3 hours.

 **CAUTION**

This treatment may damage sprouted cane.

T514-2—Saccharum (Sugarcane) (True seed (fuzz))—Deleted

Pest: *Xanthomonas albilineans* and *X. vasculorum*

Regulatory Authority

Sodium hypochlorite is no longer labeled for use on sugarcane. T514-2 has been removed under authorization of 7 CFR 305.3((b)(1)(iv)) and is subject to change pending notice and comment. Refuse entry, reexport, or destroy the commodity. (October 2020)

T514-3—Saccharum (Sugarcane) (Bagasse)

Pest: *Xanthomonas albilineans* and *X. vasculorum*

Treatment: T514-3—Dry heat treatment for 2 hours at 158 °F.

T514-4—Saccharum (Sugarcane) (Field and processing equipment)

Pest: *Xanthomonas albilineans* and *X. vasculorum*

Treatment: T514-4—Remove all debris and soil from equipment with water at high pressure (300 pounds per square inch minimum) or with steam.

T515—Treatment for Infestations of Various Sugarcane-Related Diseases

T515-1—Sugarcane (Baled)

Pest: Various sugarcane-related diseases

Treatment: T515-1—Introduce live steam into 25” vacuum until pressure reaches 15 to 20 pounds. Hold until center of bale is 220 °F–230 °F and maintain for 30 minutes.

T515-2—Sugarcane (Loose Sugarcane)

Pest: Various sugarcane-related diseases

Treatment: T515-2-1—Introduce steam into a 25” vacuum (or if with initial vacuum, “bleed” air until steam vapor fills chamber).

Treatment: T515-2-3—Dry heat at 212 °F for 1 hour.

Treatment: T515-2-4—Remove the pulp in water at 190 °F–205 °F, followed by drying at 212 °F for 1 hour.

Treatment: T515-2-5—Flash heated to 1,000 °F (Arnold dryer).

T516—(Deleted)

T517—(Deleted)

T518—Treatment for Infestations of Various Rice-Related Diseases

T518-1—Brooms Made of Rice Straw

Pest: Various rice-related diseases

Treatment: T518-1—Dry heat at 170 °F for 4.5 hours (may take 2 hours to reach this temperature)

T518-2-1—Novelties Made of Rice Straw

Pest: Various rice-related diseases

Treatment: T518-2-1—Dry heat at 180 °F–200 °F for 2 hours

Treatment: T518-2-2—Steam sterilization

Temperature (°F)	Pressure (lbs.)	Exposure Period (minutes)
260	20	15
250	15	20

T519—Treatment for Infestations of Various Rice-Related Diseases

T519-1—Closely Packed Rice Straw and Hulls

Pest: Various rice-related diseases

Treatment: T519-1—Introduce steam into 28” vacuum until pressure reaches 10 pounds and hold for 20 minutes.

T519-2—Loose Rice Straw and Hulls

Pest: Various rice-related diseases

Treatment: T519-2—Introduce steam into 28” vacuum (or if **without** initial vacuum, “bleed” air until steam vapor escapes) until pressure reaches 20 pounds AND temperature 259 °F and hold for 10 minutes (OR 10 pounds and 240 °F for 20 minutes).

NOTICE

See also [T518-1—Brooms Made of Rice Straw](#)

T520—Treatment for Infestation of *Verticillium albo-atrum* on Various Commodities

T520-1—Seeds of Alfalfa (*Medicago falcata*, *M. gaetula*, *M. glutinosa*, *M. media*, and *M. sativa*) from Europe—Deleted

Pest: *Verticillium albo-atrum*

Regulatory Authority

Thiram is no longer labeled for use on alfalfa. T520-1 and -2 have been removed under authorization of 7 CFR 305.3((b)(1)(iv)) and is subject to change pending notice and comment. Refuse entry, reexport, or destroy the commodity. (November 2020)

Treatment: T520-1-1—deleted

Treatment: T520-1-2—deleted

T521—Treatment for Infestation of Plant Pathogenic Fungi and Bacteria on Articles Made with Dried Plant Material

Pest: Various Plant Pathogenic Fungi and Bacteria

Treatment Schedules T500 - Schedules for Plant Pests or Pathogens

T521—Treatment for Infestation of Plant Pathogenic Fungi and Bacteria on Articles Made with Dried Plant Material

Dried plant material includes, but is **not** limited to, lemon grass, bamboo leaf decorations, grass arrangements, bundles, and baskets.

Treatment: T521—Heat

Conditions	Temperature	Time (hours)
Moist heat (air with high levels of water vapor, as from steam)	80 °C (176 °F)	1
Dry heat (air free of water vapor)	80 °F (176 °F)	2

Treatment time **does not** start until the entire commodity has reached treatment temperature. Warn the importer of the possibility of damage to the commodity prior to treatment. Ensure that the commodity **does not** come in contact with heating elements or open flame. The treatment facility **must** be approved by the USDA-APHIS-PPQ-S&T-TMT, certified on an annual basis by PPQ, and have a Compliance Agreement with PPQ.

Under Development: See [Heat – Steam Treatments](#) on page 3-4-1 for operational procedures and equipment guidelines.

T551—Treatment for Infestation of *Globodera rostochiensis* and *G. pallida* (Nematodes) on *Convallaria* (Pips)

T551-1—*Convallaria* (Pips)

Pest: *Globodera rostochiensis*, *G. pallida*

Treatment: T551-1—Keep pips frozen until time for treatment, then thaw enough to separate bundles from one another just before treatment begins.

Without preliminary warm-up, immerse in hot water at 118 °F for 30 minutes, following with a 5-minute drain, finishing with 5 minutes cooling dip or hosing with tap water.

T552—Treatment for Infestation of *Ditylenchus dipsaci* and *D. destructor*

T552-1—*Allium*, *Amaryllis*, and Bulbs (NSPF)

Pest: Bulb nematodes: *Ditylenchus dipsaci*, *D. destructor*

Treatment: T552-1—Presoak bulbs in water at 75 °F for 2 hours, then at 110 °–111 °F for 4 hours.

T553—Treatment for Infestations of Nematodes on Various Plant Commodities

T553-1—*Achimenes*, *Actinidia*, *Agapanthus*, *Aloe*, *Amorphophallus* (bulbs), *Ampelopsis*, *Anchusa*, *Anemone*, *Astilbe*, *Begonia* (tubers), *Bletilla hyacinthina* (bulbs)(NSPF), *Cactus*, *Calliopsis*, *Campanula*, *Cestrum*, *Cimicifuga*, *Cissus*, *Clematis*, *Convolvulus japonicus*, *Curcuma* (turmeric), *Cyclamen*, *Cytisus*, *Dahlia* (tubers), *Dracaena*, *Epimedium pinnatum* (only; other spp. not tolerant), *Euonymus alata* (only), *Eupatorium*, *Euphorbia*, *Fragaria* (strawberry), *Gardenia*, *Gentiana*, *Gerbera*, *Gesneria*, *Geum*, *Gladiolus*, *Heliopsis*, *Helleborus*, *Hibiscus*, *Hosta*, *Hoya*, *Iris*, *Jasminum*, *Kaempferia*, *Kohleria*, *Naegelia*, *Orchid*, *Ornithogalum*, *Paeonia*, *Passiflora*, *Polyanthes* (tuberose), *Primula*, *Reichsteineria*, *Sansevieria*, *Scabiosa*, *Sedum*, *Senecio* (Lingularis), *Sinningia*, *Thompsonia nepalensis*, *Tydaea*, *Verbena*, *Vitis* (grape), *Weigela*, *Zantedeschia*, *Zingiberaceae*

Pest: Root-knot nematodes (*Meloidogyne* spp.)

Treatment: T553-1—Hot water at 118 °F for 30 minutes

T553-2—*Anchusa*, *Astilbe*, *Clematis*, *Dicentra*, *Gardenia*, *Helleborus*, *Hibiscus*, *Kniphofia*, *Primula*

Pest: Lesion nematodes (*Pratylenchus* spp.)

Treatment: T553-2—Hot water at 118 °F for 30 minutes

T553-3—*Armoracia* (Horseradish Roots), *Bulbs* (NSPF)

Pest: Golden nematodes (*Globodera rostochiensis* and *G. pallida*)

Treatment: T553-3—Hot water at 118 °F for 30 minutes

T553-4—*Bletilla hyacinthina*

Pest: Foliar nematodes (*Aphelenchoides fragariae*)

Treatment: T553-4—Hot water at 118 °F for 30 minutes

Alternate treatment: T564

T553-5—*Humulus*

Pest: Cyst nematodes (*Heterodera humuli*)

Treatment: T553-5—Hot water at 118 °F for 30 minutes

T554—Treatment for Infestations of *Ditylenchus dipsaci* and *D. destructor* on *Hyacinthus*

T554-1—*Hyacinthus* (bulbs), *Iris* (bulbs and rhizomes), *Tigridia*

Pest: Bulb nematodes—*Ditylenchus dipsaci* and *D. destructor*

Treatment: T554-1-1—Presoak in water at 70 °F–80° F for 2.5 hours, followed by hot water immersion at 110 °F–111 °F for 1 hour.

Treatment: T554-1-2—Hot water immersion at 110 °F–111 °F for 3 hours with **no** presoaking.

T555—Treatment for Infestations of *Ditylenchus dipsaci* on *Narcissus*

T555-1—*Narcissus* (bulbs)

Pest: Bulb nematodes (*Ditylenchus dipsaci*)

Treatment: T555-1—Presoak in water at 70 °F–80° F for 2 hours, then at 110 °F–111 °F until all bulbs reach that temperature and hold for 4 hours.

T556—Treatment for Infestations of Root-Knot Nematodes (*Meloidogyne* spp.) on *Calla*

T556-1—*Calla* (rhizomes)

Pest: Root-knot nematodes (*Meloidogyne* spp.)

Treatment: T556-1—Dip in hot water at 122 °F for 30 minutes.

T557—Treatment for Infestations of *Meloidogyne* spp. and *Pratylenchus* spp. on *Chrysanthemum* (not including *Pyrethrum*)

T557-1—*Chrysanthemum* (not including *Pyrethrum*)

Pest: *Meloidogyne* spp. and *Pratylenchus* spp.

Treatment: T557-1—Dip in hot water at 118 °F for 25 minutes.

T558—Treatment for Infestations of *Pratylenchus* Surface Diseases on *Fragaria* (Strawberry)

T558-1—*Fragaria* (Strawberry)

Pest: *Pratylenchus* spp. (surface diseases)

Treatment: T558-1—Dip in hot water at 127 °F for 2 minutes.

T559—Treatment for Infestations of Foliar Nematodes on *Begonia* and *Oryza* (Paddy Rice)

T559-1—*Begonia*

Pest: White tip nematode (*Aphelenchoides besseyi*)

Treatment: T559-1—Dip in hot water at 118 °F for 5 minutes.

T559-2—*Oryza* (Paddy Rice)

Pest: White tip nematode (*Aphelenchoides besseyi*)

Treatment: T559-2—Dip in hot water at 132.8 °F (56 °C) for 15 minutes.

T560—Treatment for Infestations of *Meloidogyne* spp. on Rosa

T560-1—*Rosa* spp. (except *multiflora*, which is not tolerant)

Pest: *Meloidogyne* spp.

Treatment: T560-1—Dip in hot water at 123 °F for 10 minutes.

T561—Treatment for Infestations of *Cercospora mamaonis* and *Phomopsis carica-papayae* on Papayas

T561-1—Papaya

Pest: *Cercospora mamaonis* and *Phomopsis carica-papayae*

Treatment: T561-1—Dip in hot water at 120.2 °F (49 °C) for 20 minutes.

T562—(Deleted)

T563—(Deleted)

T564—Treatment for Infestations of Foliar Nematodes on Various Commodities

T564-1—*Astilbe*, *Bletilla hyacinthina*, *Cimicifuga*, *Epimedium pinnatum* (only; other spp. not tolerant), *Hosta*, *Paeonia*

Pest: Foliar nematode (*Aphelenchoides besseyi*)

Treatment: T564-1—Presoak in water at 68 °F for 1 hour followed by hot water soak at 110 °F for 1 hour. Then dip in cold water and let dry.

NOTICE

See alternative treatment for *Bletilla hyacinthina*: T553-1

T565—Treatment for Infestations of Nematodes on Various Commodities

T565-1—*Amaryllis*

Pest: *Ditylenchus destructor*

Treatment: T565-1—Hot water at 110 °F for 4 hours (should be done immediately after digging).

T565-2—*Crocus*

Pest: *Aphelenchoides subtenuis*, *Ditylenchus destructor*

Treatment: T565-2—Hot water at 110 °F for 4 hours (should be done immediately after digging).

T565-3—*Gladiolus*

Pest: *Ditylenchus destructor*

Treatment: T565-3—Hot water at 110 °F for 4 hours (should be done immediately after digging).

T565-4—*Scilla*

Pest: *Ditylenchus dipsaci*

Treatment: T565-4—Hot water at 110 °F for 4 hours (should be done immediately after digging).

T565-5—*Solanum* (Potato Tubers)

Pest: *Globodera rostochiensis*, *G. pallida*

Treatment: T565-5—Hot water at 110 °F for 4 hours (should be done immediately after digging).

T566—Treatment for Infestations of Various Diseases on Broomcorn, Broomcorn Articles, and *Lilium* (Bulbs)

T566-1—Broomcorn

Pest: Precautionary treatment for corn-related diseases

Treatment: T566-1—Hot water at 102 °F

T566-2—Broomcorn Articles

Pest: Precautionary treatment for corn-related diseases

Treatment: T566-2—Hot water at 102 °F

T566-3—*Lilium* (Bulbs)

Pest: *Aphelenchoides fragariae*

Treatment: T566-3—Hot water at 102 °F.

T567—Treatment for Infestations of Bulb Nematodes on Various Commodities

T567-1—*Muscari*, *Ornithogalum*, *Polyanthes* (Tuberose)

Pest: Bulb nematodes (*Ditylenchus dipsaci*)

Treatment: T567-1—Dip in hot water at 113 °F for 4 hours.

T568—Treatment for Infestations of Foliar Nematodes on *Senecio*

T568-1—*Senecio* (*Lingularis*)

Pest: Foliar nematodes (*Aphelenchoides fragariae*)

Treatment: T568-1—Treat with hot water at 110 °F for 1 hour.

T569—Treatment for Infestations of Foliar Nematodes on *Fragaria* (Strawberry)

T569-1—*Fragaria* (Strawberry)

Pest: Foliar nematodes (*Aphelenchoides fragariae*)

Treatment: T569-1—Hot water at 121 °F for 7 minutes. (National Plant Board Conference, Tennessee, 1968)

T570—Treatment for Infestations of Various Diseases on *Acalypha* and *Aconitum*

T570-1—*Acalypha*

Pest: *Pratylenchus* spp.

Treatment: T570-1—Hot water dip at 110 °F for 50 minutes. (Tolerance **not** established.)

T570-2—*Aconitum*

Pest: *Aphelenchoides fragariae*

Treatment: T570-2—Hot water dip at 110 °F for 50 minutes. (Tolerance **not** established.)

T571—(Deleted)

Chapter

5

Treatment Schedules

T600 - Controlled Atmosphere Temperature Treatment System

This information in this chapter has been removed.

Treatment Schedules T600 - Controlled Atmosphere Temperature Treatment System

This information in this chapter has been removed.

Treatment Schedules

D301 - Schedules for Domestic Movement of Regulated Articles

Contents

Introduction	5-8-2
D301.32-10 Fruit Fly Treatments	5-8-2
D301.50-10 Pine Shoot Beetle (<i>Tomicus piniperda</i>)	5-8-9
D301.75-11 Citrus Canker (<i>Xanthomonas axonopodis</i>)	5-8-10
D301.76 Asian Citrus Psyllid (<i>Diaphorina citri</i> Kuwayama)	5-8-13
D301.81-10 Imported Fire Ant (<i>Solenopsis invicta</i> and <i>S. richteri</i>)	5-8-15
D301.87-10 Sugarcane Leaf Scald and Gummosis Disease (<i>Xanthomonas albilineans</i> and <i>X. vasculorum</i>)	5-8-25
D301.89 Karnal Bunt (<i>Tilletia indica</i>)	5-8-26
D301.92 <i>Phytophthora ramorum</i>	5-8-27
DA-2016-55 (09/06/2016)—Sweet Orange Scab (SOS), <i>Elsinoë australis</i> (Federal Order DA-2016-55)	5-8-27
DA-2012-09 (03/16/2012)— <i>Guignardia citricarpa</i> , fungal pathogen causing the disease Citrus Black Spot (CBS) (Federal Order DA-2012-09)	5-8-30

Introduction

The treatments listed in this section are to be used **only** for domestic movement of regulated articles and are conducted in conjunction with a systems approach. State and local guidelines may apply.

D301.32-10 Fruit Fly Treatments

The fruit fly treatments are organized by family or genus and species, and then by approved site or commodity.

NOTICE

Several treatments in this section are equivalent to treatments for imported commodities found in [T100 - Schedules for Fruits, Nuts, and Vegetables](#).

In these cases, click on the hyperlink provided to go to the appropriate treatment.

Fruit Fly Family Tephritidae D301.32-10(a)—Soil in Containerized Nursery Stock

NOTICE

Refer to the appropriate EPA-approved document that gives PPQ the authority to treat at the rates described in the treatment schedules. Examples of documents include chemical manufacturer labels, special local need registration (24c or SLN), and Section 18 quarantine exemptions.

Contact the National Fruit Fly Coordinator to find out if the chemicals in the treatment schedules are registered for use in your state.

Treatment: D301.32-10(a-1) — Chemical treatment Diazinon

Application Instructions

Apply to nursery stock using equipment that generates a coarse, low-pressure spray. Soak the entire contents of the nursery stock container. Do not drench to the point of runoff. Do not allow the solution to enter sewers, drains, bodies of water, or aquatic habitats.

Table 5-8-1 Diazinon Dosages for Nursery Stock

Insecticide	Dosage Rate (lb. a.i. per acre)
Diazinon	5.0

Treatment: D301.32-10(a-2) — Chemical treatment Lambda-Cyhalothrin

The yellow and black colors of this schedule indicates that the authority to conduct the treatment comes from an emergency action required by PPQ in

order to mitigate the pest risk. The emergency action is an interim measure and is pending final regulatory approval.

Table 5-8-2 Lambda-Cyhalothrin Dosages for Nursery Stock

Insecticide	Dosage Rate (lb. a.i. per acre)
Lambda-Cyhalothrin	0.4

Application Instructions

Apply to nursery stock using equipment that generates a coarse, low-pressure spray. Soak the entire contents of the nursery stock container. Do not drench to the point of runoff. Do not allow the solution to enter sewers, drains, bodies of water, or aquatic habitats.

Fruit Fly Family Tephritidae D301.32-10(a)— Fruits, Vegetables, Cut Flowers, Foliage

Treatment: D301.32-10(a-3) — Irradiation using 70-150 Gy (not to exceed 1,000 Gy)

Refer to [Table 5-8-3](#) for a list of fruit flies that can be irradiated. Treat using the minimum absorbed dose.

Treatments must be approved in advance by PPQ Field Operations. Facilities located in AL, AZ, CA, FL, GA, KY, LA, MS, NV, NM, NC, SC, TN, TX, or VA will require additional safeguarding measures described in [7 CFR 305.9\(a\)](#).

Table 5-8-3 Pest-Specific Minimum Absorbed Dose (Gy) for Fruit Fly Irradiation

Scientific Name	Common Name	Minimum Absorbed Dose (Gy)
<i>Anastrepha ludens</i>	Mexican fruit fly	70
<i>Anastrepha obliqua</i>	West Indian fruit fly	70
<i>Anastrepha serpentina</i>	Sapote fruit fly	100
<i>Anastrepha suspensa</i>	Caribbean fruit fly	70
<i>Bactrocera cucurbitae</i>	Melon fruit fly	150
<i>Bactrocera dorsalis</i>	Oriental fruit fly	150
<i>Bactrocera jarvisi</i>	Jarvis fruit fly	100
<i>Bactrocera tryoni</i>	Queensland fruit fly	100
<i>Ceratitis capitata</i>	Mediterranean fruit fly	100
	All other fruit flies of the family Tephritidae which are not listed above	150

Anastrepha ludens (Mexican fruit fly) D301.32-10(b)

White Sapote (*Casimiroa edulis*)

Treatment: D301.32-10(b-1) — Cold treatment
(equivalent to T107-b)

Citrus

Treatment: D301.32-10(b-2) — High temperature forced air
(equivalent to T103-a-1)

Pear, Quince, Citron

Treatment: D301.32-10(b-3) — Cold treatment

Temperature	Exposure Period (days)
33 °F (0.56 °C) or below	18
34 °F (1.11 °C) or below	20
35 °F (1.67 °C) or below	22

Ceratitis capitata (Mediterranean fruit fly) D301.32-10(c)

Tomato

Treatment: D301.32-10(c-1) — MB at NAP

Temperature (°F)	Dosage Rate (lb/1,000 ft ³)	Minimum Concentration Readings (ounces) At:			
		0.5 hr.	2 hrs.	3.5 hrs.	4 hrs.
70 and above	2.0	26	21	21	—
65-69	2.0	26	21	—	19

⚠ WARNING

Host tolerance is marginal. Warn the shipper of possible injury.

Treatment: D301.32-10(c-2) — Vapor heat
(equivalent to T106-b)

Citrus

Treatment: D301.32-10(c-3) — MB at NAP — tarpaulin or chamber

Temperature (°F)	Dosage Rate (lb/1,000 ft ³)	Minimum Concentration Readings (ounces) At:	
		0.5 hr.	3.5 hrs. ¹
70 and above	2.0	26	21

1 This treatment is currently **NOT AUTHORIZED** pending EPA-approval to increase the duration to 3.5 hours.

Treatment: D301.32-10(c-4) — Cold treatment
(equivalent to T107-a)

Treatment: D301.32-10(c-5) — MB at NAP — tarpaulin or chamber followed
by cold treatment

Temperature (°F)	Dosage Rate (lb/1,000 ft ³)	Minimum Concentration Readings (ounces) At:	
		0.5 hr.	2 hrs.
70 and above	2.0	25	18
Followed by cold treatment			

Refrigeration	
Temperature	Exposure Period (days)
33 to 37 °F (0.56 to 2.77 °C)	4
OR 38 to 47 °F (3.33 to 8.33 °C)	11

Treatment: D301.32-10(c-6) — MB at NAP — tarpaulin or chamber followed
by cold treatment

Temperature (°F)	Dosage Rate (lb/1,000 ft ³)	Minimum Concentration Readings (ounces) At:		
		0.5 hr.	2 hrs.	2.5 hrs.
70 and above	2.0	25	18	18
Followed by cold treatment				

Refrigeration	
Temperature	Exposure Period (days)
34 to 40 °F (1.11 to 4.44 °C)	4
OR 41 to 47 °F (5.0 to 8.33 °C)	6
OR 48 to 56 F (8.88 to 13.33 C)	10

Treatment: D301.32-10(c-7) — MB at NAP — tarpaulin or chamber followed by cold treatment

Temperature (°F)	Dosage Rate (lb/1,000 ft ³)	Minimum Concentration Readings (ounces) At:			
		0.5 hr.	2 hrs.	2.5 hrs.	3 hrs.
70 and above	2.0	25	18	18	17
Followed by cold treatment					

Refrigeration	
Temperature	Exposure Period (days)
43 to 47 °F (6.11 to 8.33°C)	3
OR 48 to 56 °F (8.88 to 13.33 °C)	6

Bell Pepper

Treatment: D301.32-10(c-8) — Vapor heat (equivalent to T106-b)

Bactrocera dorsalis (Oriental fruit fly) D301.32-10(d)**Tomato**

Treatment: D301.32-10(d-1) — MB at NAP

Temperature (°F)	Dosage Rate (lb/1,000 ft ³)	Minimum Concentration Readings (ounces) At:		
		0.5 hr.	2 hrs.	3.5 hrs.
70 and above	2.0	26	21	21

⚠ WARNING

Host tolerance is marginal. Warn the shipper of possible injury.

Treatment: D301.32-10(d-2) — Vapor heat
(equivalent to T106-b)**Citrus and Grape**Treatment: D301.32-10(d-3) — MB at NAP — tarpaulin or chamber followed
by cold treatment

Temperature (°F)	Dosage Rate (lb/1,000 ft ³)	Minimum Concentration Readings (ounces) At:	
		0.5 hr.	2 hrs.
70 and above	2.0	25	18
Followed by cold treatment			

Refrigeration

Temperature	Exposure Period (days)
33 to 37 °F (0.56 to 2.77°C)	4
OR 38 to 47 °F (3.33 to 8.33 °C)	11

Treatment: D301.32-10(d-4) — MB at NAP — tarpaulin or chamber followed
by cold treatment

Temperature (°F)	Dosage Rate (lb/1,000 ft ³)	Minimum Concentration Readings (ounces) At:		
		0.5 hr.	2 hrs.	2.5 hrs.
70 and above	2.0	25	18	18
Followed by cold treatment				

Treatment Schedules D301 - Schedules for Domestic Movement of Regulated Articles

D301.32-10 Fruit Fly Treatments

Refrigeration	
Temperature	Exposure Period (days)
34 to 40 °F (1.11 to 4.44°C)	4
OR 41 to 47°F (5.0 to 8.33 °C)	6
OR 48 to 56 °F (8.88 to 13.33 °C)	10

Treatment: D301.32-10(d-5) — MB at NAP — tarpaulin or chamber followed by cold treatment

Temperature (°F)	Dosage Rate (lb/1,000 ft³)	Minimum Concentration Readings (ounces) At:			
		0.5 hr.	2 hrs.	2.5 hrs.	3 hrs.
70 and above	2.0	25	18	18	17
Followed by cold treatment					

Refrigeration	
Temperature	Exposure Period (days)
43 to 47 °F (6.11 to 8.33°C)	3
OR 48 to 56 °F (8.88 to 13.33 °C)	6

Treatment: D301.32-10(d-6) — Cold treatment followed by MB at NAP — tarpaulin or chamber

Refrigeration	
Temperature	Exposure Period (days)
33 or below (0.56 °C)	21
Followed by MB at NAP — tarpaulin or chamber	

Temperature (°F)	Dosage Rate (lb/1,000 ft³)	Minimum Concentration Readings (ounces) At:	
		0.5 hr.	2 hrs.
70 and above	2.0	30	25
60 to 69	2.5	36	28
40 to 59	3.0	44	36

Bell Pepper

Treatment: D301.32-10(d-7) — Vapor heat

Anastrepha serpentina (Sapote fruit fly) D301.32-10(e)

Citrus

Treatment: D301.32-10(e-1) — Methyl bromide
(equivalent to T101-j-2-1)

D301.50-10 Pine Shoot Beetle (*Tomicus piniperda*)

NOTICE

Cut trees at least 2 weeks prior to treatment in order to reduce possible damage by the fumigant to the trees. APHIS assumes **no** responsibility for damage due to the phytotoxic effects of these treatments.

D301.50-10(a) Pine Logs and Pine Lumber with Bark Attached, Pine Bark Products, and Pine Stumps

Treatment: D301.50-10(a)—MB at NAP—tarpaulin or chamber (equivalent to T404-b-1-1)

Temperature (°F)	Dosage Rate (lb/1,000 ft ³)	Minimum Concentration Readings (ounces) At:			
		0.5 hr	2 hrs	4 hrs	16 hrs
70 and above	3.0	36	30	27	25
40-69	5.0	60	51	46	42

D301.50-10(b) Christmas Trees, Pine Nursery Stock, Raw Pine Materials for Pine Wreaths and Garlands

Treatment: D301.50-10(b)—Cold Treatment

Temperature	Exposure Period (hours)
-0.5 °F (-20.6 °C)	1

Load the commodity into an APHIS-approved refrigeration unit. **Do not** start the treatment time until the refrigeration unit reaches the treatment temperature.

D301.50-10(c) Christmas Trees, Raw Pine Materials for Pine Wreaths and Garlands

Treatment: D301.50-10(c)—MB at NAP—tarpaulin or chamber (equivalent to T313-b)

Temperature (°F)	Dosage Rate (lb/1,000 ft ³)	Minimum Concentration Readings (ounces) At:			
		2 hrs	3 hrs	3.5 hrs	4 hrs
60 and above	3.0	43	–	–	36
60 °and above	4.0	57	48	–	–
50-59	3.5	50	–	–	42
50-59	4.0	57	–	48	–
40-69	4.0	57	–	–	48

D301.75-11 Citrus Canker (*Xanthomonas axonopodis*)

Conduct treatments at a commercial packinghouse operating under a compliance agreement.

NOTICE

All personnel using these treatments **must** clean their hands using one of the following disinfectants:

- ◆ Gallex 1027 Antimicrobial Soap
- ◆ Hibiclens
- ◆ Hibistat
- ◆ Sani Clean Hand Soap
- ◆ Seventy Percent Isopropyl Alcohol

D301.75-11(a-1) Regulated Fruit¹

Treatment: D301.75-11(a-1)—Chemical Treatment

Thoroughly wet the fruit for at least 2 minutes with a solution containing 0.02% (200 ppm) sodium hypochlorite maintained at a pH of 5.5 to 7.0.

Regulatory Authority

Changes to pH are effective immediately under authorization of 7 CFR 305.3((b)(1)(iv)) and are subject to change pending notice and comment. (October 2020)

See [Sodium Hypochlorite \(Bleach\) Treatments](#) on page 2-13-5 for dilution tables and pH adjustment directions. In general, adjust the pH to 5.5 to 7.0 using acetic acid (white vinegar) under a fume hood or in a well-ventilated area, and mix the following dilutions:

¹ Regulated fruit is defined as any fruit, seed, plant, plant part, grass, or tree in all species, clones, cultivars, strains, varieties, and hybrids of the genera *Citrus* and *Fortunella*, and all clones, cultivars, strains, varieties, and hybrids of the species *Clausena lansium* and *Poncirus trifoliata*. The most common of these are: calamondin, citron, ethrog, grapefruit, key lime, kumquat, lemon, limequat, mandarin, persian lime, pummelo, satsuma, sour orange, sweet orange, tangelo, tangerine, tangor, trifoliolate orange, and wampi.

- ◆ Using 8.4% sodium hypochlorite formulation, mix 1 part in 419 parts of water.
- ◆ Using 12.5% sodium hypochlorite formulation, mix 1 part in 624 parts of water.

The use site must be listed on the label. To minimize corrosion of surfaces in contact with bleach, thoroughly wash down all work areas.

D301-75-11(a-2) Regulated Fruit¹

Treatment: D301.75-11(a-2)—Chemical Treatment

Thoroughly wet the fruit with a solution containing sodium o-phenyl phenate (SOPP) at a concentration of 1.86 to 2.0 percent of the total solution. If the solution has sufficient soap or detergent to cause a visible foaming action, wet for 45 seconds. If the solution **does not** contain sufficient soap to cause a visible foaming action, wet for 1 minute. Apply according to all label directions.

D301.75-11(a-3) Regulated Fruit¹

Treatment: D301.75-11(a-3)—Chemical Treatment

Thoroughly wet the fruit with a solution of 85 ppm peroxyacetic acid for at least 1 minute. Apply according to all label directions.

D301.75-11(b) Regulated Seed²

Treatment: D301.75-11(b)—Chemical and Heat Treatment (equivalent to [T511-1—Seeds of *Citrus* spp., *Fortunella* spp., *Clausena lansium* and *Poncirus trifoliata* \(and all cultivars, varieties, and hybrids\)](#))

Following extraction from fruit treated as described in D301.75-11(a-1, 2, or 3):

1. Wash the seeds to remove the pulp.
2. Immerse in water heated to 125 °F (51.6 °C) or higher for 10 minutes.
3. Immerse in a solution containing 0.525% (5,250 ppm) sodium hypochlorite for at least 2 minutes.

Regulatory Authority

Changes to sodium hypochlorite concentration and pH are effective immediately under authorization of 7 CFR 305.3((b)(1)(iv)) and are subject to change pending notice and comment. (October 2020)

² Regulated seed is defined as any seed in all species, clones, cultivars, strains, varieties, and hybrids of the genera *Citrus* and *Fortunella*, and all clones, cultivars, strains, varieties, and hybrids of the species *Clausena lansium* and *Poncirus trifoliata*.

See [Sodium Hypochlorite \(Bleach\) Treatments](#) on page 2-13-5 for dilution tables and pH adjustment directions. In general, adjust the pH to 5.5 to 7.0 using acetic acid (white vinegar) under a fume hood or in a well-ventilated area, and mix the following dilutions:

- ◆ Using 8.25%, 8.3%, 8.5%, or 8.6% sodium hypochlorite formulations, mix 1 part in 15 parts of water.

The use site must be listed on the label. To minimize corrosion of surfaces in contact with bleach, thoroughly wash down all work areas.

D301.75-11(d) Vehicles, Equipment, and Other Inanimate Articles

Treatment: D301.75-11(d)—Chemical or Heat Treatment

All vehicles, equipment, and other articles for which treatment is required **must** be cleaned and disinfected by removing all plants, leaves, twigs, fruit, and other plant parts from all areas of the equipment or vehicles, including in cracks, under chrome strips, and on the undercarriage of vehicles, by wetting all surfaces (including the inside of boxes and trailers), to the point of runoff, with one of the following disinfectants:

- ◆ 0.2 percent solution of a quaternary ammonium chloride (QAC) compound
 - ◆ Solution containing 85 parts per million (ppm) peroxyacetic acid (indoor use **only**)
 - ◆ Solution of hot water and detergent, under high pressure (at least 30 pounds per square inch), at a minimum temperature of 160 °F
 - ◆ Steam, at a minimum temperature of 160 °F at the point of contact
 - ◆ 0.02% (200 ppm) solution of sodium hypochlorite with a pH of 5.5 to 7.0. The label must include the use site “Sanitization of non-porous, non-food contact surfaces.”
1. Wet all surfaces with the 0.02% sodium hypochlorite solution to the point of runoff.
 2. Let stand for 15 minutes.
 3. Thoroughly wash down all surfaces after 15 minutes to minimize corrosion.
 - ❖ See [Sodium Hypochlorite \(Bleach\) Treatments](#) on page 2-13-5 for dilution tables and pH adjustment directions. In general, adjust the pH

to 5.5 to 7.0 using acetic acid (white vinegar) under a fume hood or in a well-ventilated area.

Regulatory Authority

Changes to sodium hypochlorite pH are effective immediately under authorization of 7 CFR 305.3(b)(1)(iv) and are subject to change pending notice and comment. (October 2020)

D301.76 Asian Citrus Psyllid (*Diaphorina citri* Kuwayama)

D301.76(a-1) Curry Leaf (*Bergera (=Murraya) koenigii*) and Other Regulated Articles for Consumption, Apparel or Similar Personal Accessory, or Decorative Use

Origin: Areas **without** citrus greening (Citrus huanglongbing (HLB))
Refer to the [Citrus Diseases web page](#) for detailed information on all citrus diseases. Information includes an [interactive map](#) showing all citrus quarantines, in addition to hyperlinks to active Federal Orders.

Treatment: D301.76(a-1)—MB at NAP—tarpaulin or chamber (equivalent to T101-n-2)

NOTICE

Curry leaf and kaffir lime leaf **must** be treated as a Section 18 crisis exemption. In addition, citron, clementine, lemon, lime, mandarin, orange, tangelo, and tangerine **must** be treated using no more than 3 pounds at 50 °F. The label **does not** allow fumigation of these citrus commodities at dosages greater than 3 pounds.

D301.76(a-2) Curry Leaf (*Bergera (=Murraya) koenigii*) and Other Regulated Articles for Consumption, Apparel or Similar Personal Accessory, or Decorative Use

Treatment: D301.76(a-2)—Irradiation at 400 Gy (equivalent to T105-a-2)

Treat using a minimum absorbed dose of 400 Gy, **not** to exceed 1,000 Gy.

D301.76(a-3) Curryleaf (*Bergera (=Murraya) koenigii*), Kaffir lime leaf (*Citrus hystrix*), and Bael leaf (*Aegle marmelos*) for consumption

Treatment: D301.76(a-3)—Processing

NOTICE

The processing protocol has been added under the authority of [Federal Order DA-2022-07](#), published May 12, 2022, and is pending final regulatory approval. The “Protocol for the Interstate Movement of Fresh, Mature Rutaceous Leaves for Consumption” is included as part of the Federal Order. The treatment is subject to change or removal based on public comment. (7 CFR 305.3(b)(2))

Processing includes specific harvesting, washing, rinsing, drying, and packaging requirements. The approved washing products are listed in [Table 5-8-4](#).

Table 5-8-4 Food Grade Washing Products for Leaf Washing for ACP

Product	Rate Per Gallon
Environne	1/4 cup
Rebel Green	1/4 cup
Veggie Wash	1/4 cup

D301.76(b) Citrus Nursery Stock and Related Hosts³

Origin: Areas with Asian Citrus Psyllid

Refer to the [Citrus Diseases web page](#) for detailed information on all citrus diseases. Information includes an [interactive map](#) showing all citrus quarantines, in addition to hyperlinks to active Federal Orders.

Treatment: D301.76(b)—Chemical Treatment

³ Regulated articles for Asian Citrus Psyllid (ACP) and Citrus Greening (CG) (hosts within the plant family Rutaceae) may be intended for consumption, as apparel, or similar personal accessory, or decorative use:
All plants and plant parts (including leaves), except fruit, of the following species: *Aegle marmelos*, *Aeglopsis chevalieri*, *Afraegle gabonensis*, *A. paniculata*, *Amyris madrensis*, *Atalantia* spp. (including *Atalantia monophylla*), *Balsamocitris dawei*, *Bergera (=Murraya) koenigii*, *Calodendrum capense*, *Choisya ternate*, *C. arizonica*, *X Citroncirus webberi*, *Citropsis articulata*, *Citropsis gilletiana*, *Citrus madurensis* (=X *Citrofortunella microcarpa*), *Citrus* spp., *Clausena anisum-olens*, *C. excavate*, *C. indica*, *C. lansium*, *Eremocitrus glauca*, *Eremocitrus hybrid*, *Esenbeckia berlandieri*, *Fortunella* spp., *Limonia acidissima*, *Merrillia caloxylon*, *Microcitrus australasica*, *M. australis*, *M. papuana*, *X Microcitronella* spp., *Murraya* spp., *Naringi crenulata*, *Pamburus missionis*, *Poncirus trifoliata*, *Severinia buxifolia*, *Swinglea glutinosa*, *Tetradium ruticarpum*, *Toddalia asiatica*, *Triphasia trifolia*, *Vepris (=Toddalia) lanceolata*, and *Zanthoxylum fagara*.

Treat plants with an APHIS-approved soil drench or in-ground granular systemic insecticide, followed by a foliar spray at specified time periods prior to shipment (refer to [Table 5-8-5](#)). The treatments will be followed by a visual inspection for living psyllids according to the requirements listed in 7 CFR 301.76.

Table 5-8-5 APHIS-approved Insecticides for Control of Psyllids on Citrus

USDA-approved Soil Drench or In-ground Granular Chemicals:	USDA-approved Foliar Chemicals
Dinotefuran	Bifenthrin
Imidacloprid	Chlorpyrifos
	Deltamethrin
	Fenpropathrin
	Imidacloprid/Cyfluthrin

NOTICE

Apply the SOIL DRENCH or IN-GROUND GRANULAR chemicals **no** more than 90 days but **no** less than 30 days prior to interstate movement. All treatments **must** be applied according to their EPA label, including application directions, restrictions on place of application, and any other precautions and statements pertaining to Worker Protection Standards.

Apply the FOLIAR chemicals **no** more than 14 days prior to interstate movement. All treatments **must** be applied according to their EPA label, including application directions, restrictions on place of application, and any other precautions and statements pertaining to Worker Protection Standards.

D301.81-10 Imported Fire Ant (*Solenopsis invicta* and *S. richteri*)

D301.81-10(1) Used Soil Moving Equipment

Treatment: D301.81-10(1)—Cleaning Treatment

Used soil moving equipment is eligible for movement when an inspector determines that one of the following procedures has been done:

- ◆ It has been brushed free of noncompacted soil
- ◆ It has been washed free of noncompacted soil
- ◆ Noncompacted soil has been removed with air pressure equipment using compressors designed specifically for this purpose. Such compressors **must** provide free air delivery of **no** less than 30 ft³ per minute at 200 pounds per square inch (in²).

Certification period: The certification will be valid as long as the equipment remains free of noncompacted soil.

Limitations: Regardless of the type of cleaning equipment used, all debris and noncompacted soil **must** be removed unless it is steam-heated by a “steam jenny” to disinfest the articles. Used soil moving equipment, such as bulldozers, dirt pans, motor graders, and draglines are difficult to clean sufficiently to eliminate pest risk.

 **CAUTION**

Steam may remove loose paint and usually is **not** recommended for use on equipment with conveyor belts and rubber parts.

D301.81-10(2) Hay and Straw

Baled hay and straw stored in direct contact with the ground is ineligible for movement from the quarantined area to an area outside the quarantine unless inspected, found free of IFA, and issued a certificate.

D301.81-10(3) Nursery Stock—Balled or in Containers

There are four application methods for plants in containers or balled and burlapped. The methods are:

- ◆ Method A—Immersion
- ◆ Method B—Drench
- ◆ Method C—Topical Application
- ◆ Method D—Granular Incorporation

Method A—Immersion

Equipment: You will need an open-top, watertight container sufficiently large to accommodate the treating solution and plants.

Procedure: Follow these steps to treat the plants:

Step 1: Choose an appropriate site.

Locate the immersion tank in a well-ventilated place. The location should be covered, if possible. **Do not** remove burlap wrap or plastic containers with drain holes before immersion.

Step 2: Immerse the plants.

Immerse the soil balls and containers, singly or in groups, so that the soil is completely covered by the insecticidal solution. Allow the plants to remain in the solution until bubbling ceases.

NOTICE

Thorough saturation of the plant balls or containers with the insecticide solution is essential!

Step 3: Remove the plants from the dip.

After removal from the dip, set the plants on a drainboard until adequately drained.

Step 4: Add treating mixture.

As treating progresses, add freshly prepared insecticide mixture to maintain the liquid at immersion depth.

Step 5: Dispose of solution.

Dispose of tank contents 8 hours after mixing. Disposal **must** comply with state and local regulations.

NOTICE

Do not permit runoff of the solution from the treatment area! Dispose of excess and unused solution in accordance with state and local regulations.

CAUTION

Wear rubber gloves, boots, and apron during this operation.

Insecticides, Dosages, and Certification Periods

Refer to [Table 5-8-6](#) for dosages and certification periods for approved insecticides.

Table 5-8-6 Insecticides for Immersion Treatment of Balled or Containerized Plants

Insecticide (liquid)	Dosage (lb. active ingredient per 100 gallons water)	Certification Period (days)
Chlorpyrifos	0.125	30
Bifenthrin	0.115	180
	0.05	120
	0.025	60

Exposure Period: Plants certifiable immediately upon completion of treatment.

NOTICE

Environmental factors significantly affect phytotoxicity. Dwarf yaupon, some varieties of azaleas, camellias, poinsettias, rose bushes, and variegated ivy may show phytotoxicity to chlorpyrifos. It is recommended that a small group of plants be treated at the recommended rate under the anticipated growing conditions and observed for phytotoxic symptoms for at least 7 days before a large number of plants are treated.

CAUTION

The professional user assumes the responsibility for determining if bifenthrin is safe to treat plants under commercial growing conditions.

Method B—Drench

Equipment: You will need the following pieces of equipment to drench the plants:

- ◆ A large-capacity bulk mixing tank, either pressurized or gravity-flow, for mixing and holding the insecticide solution
- ◆ Properly equipped hoses and watering nozzles that can be attached to the mixing tank and used to thoroughly saturate the plant balls with insecticide solution

Containerized Plants

Step 1: Prepare the solution

The volume of the treating solution **must** be at least 20 percent (1/5) of the volume of the container.

Insecticides and Dosages

Table 5-8-7 Insecticides and Dosages for Drenching Plants in Containers

Insecticide	Dosage
Chlorpyrifos (4EC)	4 fl. oz. per 100 gallons water
Chlorpyrifos (2EC)	8 fl. oz. per 100 gallons water
Bifenthrin	25 parts per million (ppm) ¹

¹ Dose rate for bifenthrin is 25 ppm based on dry weight bulk density of the potting media. Refer to [Table 5-8-8](#) for bulk density calculations.

Table 5-8-8 Bifenthrin Calculations Based on Bulk Density

Potting Media Bulk Density (lb/yd ³)	Oz. Bifenthrin/100 gallons water
200	2.4
400	4.8
600	7.2
800	9.6
1,000	12.0
1,200	14.4
1,400	16.8

Step 2: Apply the solution

Apply solution to the point of saturation one time **only**. The volume of the solution should be one-fifth the volume of the container.

NOTICE

Thorough saturation of the plant balls or containers with the insecticide solution is essential. **Do not** permit runoff of the solution from the treatment area! Dispose of excess and unused solution in accordance with state and local regulations.

Exposure Period: Plants are certifiable immediately upon completion of treatment.

Certification Period:

Table 5-8-9 Certification Period for Plants in Containers

Insecticide	Certification Period (days)
Chlorpyrifos	30
Bifenthrin	180

Balled and Burlapped (B&B) Plants

Step 1: Select a site for the treatment

Move the plants to a well-ventilated place normally used to maintain plants prior to shipment. Cover the treatment locations, if possible. The treatment will be enhanced by adding any agricultural wetting agent or surfactant.

Step 2: Apply the solution

Do not remove burlap wrap or baskets from plants prior to treatment. The total volume of the treating solution must be 20 percent (1/5) the volume of the root ball. Treat plants singly or in groups with chlorpyrifos solution twice in one day. Apply one-half the total drench solution, wait at least 30 minutes, then rotate the root ball and apply the second one-half drench solution. Rotating or flipping the root ball between drench applications is required to insure all sides of the root ball are sufficiently treated.

⚠ CAUTION
Wear rubber gloves, boots, and apron during this operation.

Dosage:

Table 5-8-10 Emulsifiable Chlorpyrifos Dosage for Balled Plants

Chlorpyrifos formulation	Amount of formulation to make 100 gallons of treating solution
1 EC	16 fl. oz. (472 ml)
2 EC	8 fl. oz. (236 ml)
4 EC	4 fl. oz. (118 ml)

Exposure period: Plants are certifiable immediately upon completion of treatment.

Certification period: 30 days

Method C—Topical Application

Bifenthrin liquid is the **only** insecticide and formulation registered for topical application. Use this method **only** with nursery stock in 3- and 4-quart containers. Penetration of the insecticide in larger containers **does not** provide sufficient residual activity. Prepare a mix with the appropriate amount of bifenthrin in 1,000 oz. of water based on the container size and the bulk density of potting media. Refer to [Table 5-8-11](#) for the bulk density.

Table 5-8-11 Potting Media Bulk Density

Potting Media Bulk Density (lb/yd ³)	Oz. Bifenthrin liquid/1,000 fl. oz. water	
	3-quart Pots	4-quart Pots
200	3.6	5.2
400	7.2	10.4
600	10.8	15.6
800	14.4	20.8
1,000	18.0	26.0
1,200	21.6	31.2
1,400	25.2	36.4

Apply 1 fluid ounce of the mix to each container evenly distributed over the surface of the potting media.

Irrigate all treated containers with 1.5 inches of water following application.

NOTICE

Do not permit runoff of the solution from the treatment area! Dispose of excess and unused solution in accordance with state and local regulations.

Certification Period: 180 days

Method D—Granular Incorporation

There is one granular insecticide registered and approved for incorporation into potting media:

- ◆ Granular bifenthrin

Use soil mixing equipment that will adequately mix and thoroughly blend the required dosage of insecticide throughout the potting media.

Dosage is based on the bulk density of the potting media and the desired certification period. Dosage is expressed as parts per million (ppm) and calculated by the formula in [Figure 5-8-1](#).

$$\frac{\text{Bulk Density of Media} \times \text{Desired ppm}}{\text{Concentration of Insecticide}} = \frac{\text{Pounds Insecticide Needed}}{\text{Cubic Yard of Media}}$$

Figure 5-8-1 Formula for Calculating Granular Insecticide for Treating Potting Media for IFA

Regulatory Authority

Changes to [Table 5-8-12](#) are effective immediately under authorization of 7 CFR 305.3((b)(1)(iv)) and are subject to change pending notice and public comment. (August 2020)

- ◆ Delete Fipronil
- ◆ Delete Tefluthrin

Table 5-8-12 Application Rates for Incorporation of Granular Insecticides into Potting Media

Insecticide	Dosage (ppm)	Certification Period (months after treatment)
Bifenthrin	10	0-6 months
	12	0-12 months
	15	0-24 months
	25	Continuous ¹

1 Continuous certification with 25 ppm dosage when all other provisions of the Imported Fire Ant detection, control, exclusion, and enforcement program for nurseries producing containerized plants are met (7CFR 301.81-11).

D301.81-10(5) In-Field Treatment for B&B Stock Prior to Harvest

This in-field treatment is based on a sequential application of any of the following approved baits followed by a broadcast application of chlorpyrifos:

- ◆ abamectin
- ◆ fenoxycarb
- ◆ hydramethylnon
- ◆ indoxacarb (added under the authority of 7 CFR 305.3 (a)(b) and pending final regulatory approval)
- ◆ metaflumizone
- ◆ methoprene
- ◆ pyriproxyfen

The combination treatment is necessary since broadcast application of chlorpyrifos (or other short-term residual insecticides) usually **does not** eliminate large, mature IFA colonies, and baits are **not** capable of providing a residual barrier against reinfestation by new queens. Therefore, the approved bait application will drastically reduce the IFA population while chlorpyrifos, applied approximately 5 days later, will destroy any remaining weakened colonies and also leave a residual barrier against reinfestation by new queens for at least 12 weeks.

Method: Apply approved bait **only** when ants are actively foraging using a granular applicator capable of applying the labeled rates of 1.0–1.5 lb (0.45–0.68 kg) of bait per acre. Three to five days after the approved bait application, apply chlorpyrifos broadcast at 6.0 lb (2.7 kg) active ingredient (a.i.) per acre. Treatment area **must** extend at least 10 feet beyond the base of all plants that are to be certified.

Dosage: Apply approved baits at 1.0–1.5 lb (0.45–0.68 kg) bait/acre. Apply granular chlorpyrifos at 6.0 lb (2.7 kg) a.i./acre.

Exposure Period: 30 days. Plants are certifiable 30 days after treatment.

Certification Period: 12 weeks; an additional 12 weeks of certification can be obtained with a second application of granular chlorpyrifos.

D301.81-10(6) Blueberries and Other Fruit and Nut Nursery Stocks

Certain states have special local need labeling in accordance with section 24(c) of FIFRA for D-z-n Diazinon AG-500 and D-z-n Diazinon 50W, which APHIS will recognize as a regulatory treatment for containerized nonbearing blueberries and fruit and nut plants. Follow the label directions for use.

D301.81-10(7) Greenhouse Grown Plants

Greenhouse grown plants are certifiable **without** treatment if the inspector determines that the greenhouse is constructed of fiberglass, glass, or plastic in such a way that the IFA is physically excluded and **cannot** become established within the enclosure. **No** other treatment of the plants will be necessary if they are **not** exposed to infestation.

D301.81-10(8) Grass—Sod

Method:

Step 1: Apply the insecticide.

- ◆ Chlorpyrifos: apply a single broadcast application of chlorpyrifos with ground equipment
- ◆ Fipronil or bifenthrin: apply two sequential broadcast applications 1 week apart of granular fipronil or liquid bifenthrin

Table 5-8-13 Pesticide Dosages for Grass Sod

Material	Dosage (lb. a.i. per acre)	Exposure Period	Certification Period (after exposure period)
Chlorpyrifos	8.0	48 hours	6 weeks
Fipronil—granular	Apply 0.0125 two times, 1 week apart for a total dosage of 0.0250	30 days	20 weeks
Bifenthrin—liquid	Apply a dosage of 0.2 two times, 1 week apart for a total dosage of 0.4. Apply the first dosage of 0.2 and then 7 days later apply a second dose of 0.2 (total dosage of 0.4)	4 weeks (28 days)	16 weeks

EXAMPLE You are applying liquid bifenthrin to 1 acre of fire ant infested grass sod. Using a broadcast applicator, apply 0.2 lb. a.i. per acre and then 7 days later, apply a second dosage of 0.2 lb. a.i. per acre. After 28 days exposure period, you may harvest and ship sod for 16 weeks. To continue harvesting from the same area after that time, you would have to re-treat.

Step 2: Water the treated areas.

Immediately after treatment, water the treated areas with at least 1/2 inch of water.

D301.81-10(9) Soil—Bulk

Method: Bulk soil is eligible for movement when heated either by dry or steam heat after all parts of the mass have been brought to the required temperature.

Temperature: 150 °F (65.5 °C)

Certification Period: As long as protected from recontamination.

D301.81-10(10) Soil Samples

Soil samples are eligible for movement when heated or frozen as follows:

Method (heat): Soil samples are heated either by dry heat or steam heat. All parts of the mass **must** be brought to the required temperature.

Temperature: 150 °F (65.5 °C)

Certification Period: As long as protected from recontamination.

Method (frozen): Soil samples are frozen in any commercial cold storage, frozen food locker, or home freezer capable of rapidly reducing to and maintaining required temperature. Soil samples will be placed in containers, such as plastic bags—one sample per bag. The containers will be arranged in the freezer in a manner to allow the soil samples to freeze in the fastest possible time. If desired, the frozen samples may be shipped in one carton.

Temperature: -10 °F to -20 °F (-23 °C to -29 °C) for at least 24 hours

Certification Period: As long as protected from recontamination.

D301.87-10 Sugarcane Leaf Scald and Gummosis Disease **(*Xanthomonas albilineans* and *X. vasculorum*)**

D301.87-10(a) Seed Pieces

Treatment: D301.87-10(a)—Hot water (equivalent to T514-1)

Presoak in water at room temperature for 24 hours, then immerse in water at 122 °F for 3 hours.

D301.87-10(b) True Seed (Fuzz)—Deleted

Treatment: D301.87-10(b)—Chemical Treatment (equivalent to T514-2)

Regulatory Authority

Sodium hypochlorite is no longer labeled for use on sugarcane. D301.87-10(b) has been removed under authorization of 7 CFR 305.3((b)(1)(iv)) and is subject to change pending notice and comment. (October 2020)

D301.87-10(c) Bagasse

Treatment: D301.87-10(c)—Dry Heat Treatment (equivalent to T514-3)

Apply dry heat for 2 hours at 158 °F.

D301.87-10(d) Field and Processing Equipment

Treatment: D301.87-10(d)—High Pressure Wash (equivalent to T514-4)

Remove all debris and soil from equipment with water at high pressure (300 pounds per square inch minimum) or with steam.

D301.87-10(e) Juice

Treatment: D301.87-10(e)—Heat

Heat at 212 °F (100 °C) for 10 minutes or more.

D301.89 Karnal Bunt (*Tilletia indica*)

D301.89-13(a) Equipment, Grain Elevators, Conveyances, and Other Structures Used for Storing and Handling Wheat, Durum Wheat, or Triticale

Treatment: D301.89-13(a)—Chemical Treatment

1. Wet all surfaces to the point of runoff with 1.5%(15,000 ppm) sodium hypochlorite solution:
 - ◆ Using 8.25%, 8.3%, 8.5%, or 8.6% sodium hypochlorite formulations, mix 1 part in 4 parts of water
2. Let stand for 15 minutes.
3. Thoroughly wash down all surfaces after 15 minutes to minimize corrosion.

The use site must be listed on the label. See [Sodium Hypochlorite \(Bleach\) Treatments](#) on page 2-13-5 for dilution tables.

Regulatory Authority
Changes to sodium hypochlorite concentration are effective immediately under authorization of 7 CFR 305.3((b)(1)(iv)) and are subject to change pending notice and comment. (October 2020)

D301.89-13(b) Equipment, Grain Elevators, Conveyances, and Other Structures Used for Storing and Handling Wheat, Durum Wheat, or Triticale

Treatment: D301.89-13(b)—Steam

Apply steam to all surfaces until the point of runoff, and so that a temperature of 170 °F is reached at the point of contact.

D301.89-13(c) Equipment, Grain Elevators, Conveyances, and Other Structures Used for Storing and Handling Wheat, Durum Wheat, or Triticale

Treatment: D301.89-13(c)—Hot Water and High Pressure

Clean with a solution of detergent and water at a minimum of 170 °F. Apply under pressure of at least 30 pounds per square inch.

D301.92 *Phytophthora ramorum*

D301.92-10(a) Soil

Treatment: D301.92-10(a)—Heat Treatment

Heat to a temperature of at least 180 °F at the center of the load for 30 minutes in the presence of an inspector.

D301.92-10(b) Wreaths, Garlands, and Greenery of Host Material

Treatment: D301.92-10(b)—Hot Water

Dip for 1 hour in water that is held at a temperature of at least 160 °F.

D301.92-10(c) Bay Leaves

Treatment: D301.92-10(c)— Vacuum Heat (formerly T111-a-1)

1. Place bay leaves in a vacuum chamber.
2. Starting at 0 hour, gradually reduce to 0.133 Kpa vacuum at 8 hours.
3. Maintain the vacuum until the end of the treatment, 22 hours.
4. Gradually increase the temperature in the vacuum chamber from ambient temperature at 0 hour to 60 °C at 5 hours.
5. After 5 hours, gradually lower the temperature to 30 °C at 22 hours.

The total length of the treatment is 22 hours.

DA-2016-55 (09/06/2016)—Sweet Orange Scab (SOS), *Elsinoë australis* (Federal Order DA-2016-55)

NOTICE

Federal Order DA-2016-55 issued 09/06/2016 superseded Federal Order DA-2013-13 issued 04/02/2013.

Regulated Articles⁴

Conduct treatments at a commercial packinghouse operating under a compliance agreement. Regulated fruit can move interstate with a certificate to all States. For interstate movement under a limited permit, refer to the [APHIS-Approved Packing House Procedures](#).

WARNING

Chemicals and fungicides must be applied in accordance with label directions.

Step 1: Wash.

Step 2: Brush.

Step 3: Surface disinfect using at least one of the chemicals in DA-2016-55.

DA-2016-55 (a-1)

Treatment: DA-2016-55 (a-1) — Chemical Treatment

Thoroughly wet the fruit for at least 2 minutes with a solution containing 200 parts per million sodium hypochlorite. Maintain the solution at a pH of 6.0 to 7.5.

See [Sodium Hypochlorite \(Bleach\) Treatments](#) on page 2-13-5 for dilution tables and pH adjustment directions. Adjust the pH using acetic acid (white vinegar) under a fume hood or in a well-ventilated area.

⁴ Regulated articles include fruit, plants, plant products (except seeds) of *Citrus* spp. and *Fortunella* spp. Regulated fruit must be free of leaves, stems that are 1-inch or less in length, or other regulated material.

DA-2016-55 (a-2)

Treatment: DA-2016-55 (a-2)— Chemical Treatment

Thoroughly wet the fruit with a solution containing sodium o-phenyl phenate (SOPP) at a concentration of 1.86 to 2.0 percent of the total solution. If the solution has sufficient soap or detergent to cause a visible foaming action, wet for 45 seconds. If the solution does not contain sufficient soap to cause a visible foaming action, wet for 1 minute.

DA-2016-55 (a-3)

Treatment: DA-2016-55 (a-3)— Chemical Treatment

Thoroughly wet the fruit with a solution of 85 parts per million peroxyacetic acid for at least 1 minute.

Step 4: Treat with at least one of the fungicides in Table 5-8-14.

Table 5-8-14 Sweet Orange Scab Approved Fungicides

Chemical Name
Imazalil
Thiabendazole
Combination of fludioxonil plus azoxystrobin

Step 5: Wax.

DA-2012-09 (03/16/2012)—*Guignardia citricarpa*, fungal pathogen causing the disease Citrus Black Spot (CBS) (Federal Order DA-2012-09)

Regulated Articles⁵

Conduct treatments at a commercial packinghouse operating under a compliance agreement. Regulated fruit can move interstate with a certificate to all States. For interstate movement under a limited permit, refer to the [APHIS-Approved Packing House Procedures](#).

⚠ WARNING

Chemicals and fungicides must be applied in accordance with label directions.

Step 1: Wash.

Step 2: Brush.

Step 3: Surface disinfect using at least one of the chemicals in DA-2012-09.

DA-2012-09(a-1)

Treatment: DA-2012-09 (a-1) — Chemical Treatment

Thoroughly wet the fruit for at least 2 minutes with a solution containing 200 parts per million sodium hypochlorite. Maintain the solution at a pH of 6.0 to 7.5.

See [Sodium Hypochlorite \(Bleach\) Treatments](#) on page 2-13-5 for dilution tables and pH adjustment directions. Adjust the pH using acetic acid (white vinegar) under a fume hood or in a well-ventilated area.

⁵ Regulated articles include fruit, plants, plant products of *Citrus* spp.

DA-2012-09(a-2)

Treatment: DA-2012-09 (a-2)— Chemical Treatment

Thoroughly wet the fruit with a solution containing sodium o-phenyl phenate (SOPP) at a concentration of 1.86 to 2.0 percent of the total solution. If the solution has sufficient soap or detergent to cause a visible foaming action, wet for 45 seconds. If the solution does not contain sufficient soap to cause a visible foaming action. wet for 1 minute.

DA-2012-09(a-3)

Treatment: DA-2012-09(a-3) — Chemical Treatment

Thoroughly wet the fruit with a solution of 85 parts per million peroxyacetic acid for at least 1 minute.

Step 4: Treat with at least one of the fungicides in Table 5-8-15.

Table 5-8-15 Citrus Black Spot Approved Fungicides

Chemical Name
Imazalil
Thiabendazole

Step 5: Wax.

Treatment Schedules *D301 - Schedules for Domestic Movement of Regulated Articles*

DA-2012-09 (03/16/2012)—Guignardia citricarpa, fungal pathogen causing the disease Citrus Black Spot (CBS) (Federal

Certifying Facilities

Overview

Contents

Certification of Vacuum Fumigation Chambers	6-2-1
Certifying Normal Atmospheric Fumigation Chambers	6-3-1
Certification of Cold Treatment	6-4-1
Certification of Hot Water Immersion Facilities	6-5-1
Certification of Niger seed Treatment Facilities	6-6-1
Certification of Forced Hot Air and Vapor Heat Treatment Facilities	6-7-1
Certifying Irradiation Treatment Facilities	6-8-1
Certifying Facilities for the Heat Treatment of Firewood	6-9-1

The Certification of Facilities section of this manual is organized by the following categories:

- ◆ Vacuum Fumigation Chambers
- ◆ Atmospheric Fumigation Chambers
- ◆ Cold Treatment Facilities
- ◆ Hot Water Immersion Facilities
- ◆ Niger seed Treatment Facilities
- ◆ Forced Hot Air and Vapor Heat Treatment Facilities
- ◆ Irradiation Treatment Facilities
- ◆ Firewood Heat Treatment Facilities

Domestic and foreign treatment facilities **must** be certified by APHIS before they can perform treatments to meet United States quarantine requirements. Specific requirements for each type of facility are included in this section.

After the USDA-APHIS-PPQ-S&T-TMT has approved blueprints or drawings of a treatment facility, the treatment facility can request certification from Plant Protection and Quarantine at local ports or State Plant Health Directors.

NOTICE

Send blueprints or drawings of domestic treatment facilities to:

USDA-APHIS-PPQ-S&T-TMT
13601 Old Cutler Road, Bldg. 63
Miami, FL 33158 USA
Phone: 305-278-4877
Fax: 305-278-4898
email: ppqmt@usda.gov

Request certification from the State Plant Health Directors listed on the [PPQ Plant Health Program Overview website](#).

NOTICE

Send blueprints or drawings and request for certification of foreign treatment facilities to:

Director, Preclearance Programs
USDA-APHIS-PPQ
4700 River Road, Unit 60
Riverdale, MD 20737
Phone: (301) 851-2312

For foreign treatment facilities, the company requesting certification is responsible for paying money into a trust fund account to pay the salary, travel costs, and per diem of a PPQ Officer to be sent on temporary duty.

Sea-going vessels that participate in the APHIS cold treatment program for fresh fruit may be certified at a port in the USA or at a foreign port. Also, if the certification is to be carried out overseas, a trust fund account will be needed to cover the costs.

For details, call PPQ Quarantine Policy, Analysis and Support (QPAS) at (301) 851-2312.

Certifying Facilities

Certification of Vacuum Fumigation Chambers

Contents

Submission and Approval of a New Chamber Construction	6-2-1
Construction and Performance Standards	6-2-1
Vacuum Chamber	6-2-2
Vacuum Pump	6-2-2
Fumigant Introduction Systems	6-2-2
Circulation and Exhaust System	6-2-3
Accessories	6-2-3
Certification Standards	6-2-4
Checklist	6-2-6

Submission and Approval of a New Chamber Construction

The facility submits an engineering construction plan and chamber requirements to the appropriate State and country officials and to USDA-APHIS-PPQ-S&T-TMT for approval.

Download a fillable Application for USDA Fumigation Facility Approval Form located on the [S&T website](#).

Contact ppqmt@usda.gov with questions regarding the application.

Construction and Performance Standards

Vacuum fumigation consists of placing the commodity in a gas tight metal chamber, removing most of the air, and replacing a small portion of it with a gas which is lethal to insects and other pests. Vacuum fumigation provides a more rapid penetration of commodities undergoing treatment than is obtained in normal atmospheric fumigations.

Vacuum Chamber

Vacuum chambers are usually welded steel construction. A rectangular chamber might be preferred for more effective use of space. Reinforcement of the chamber body by means of steel ribs, or other supports, is usually required to enable the chamber to withstand the difference in pressures when the vacuum is drawn. Doors can be provided at one or both ends of the chamber. In cylindrical chambers, the doors can be either concave or convex, but in rectangular chambers flat doors are commonly used with suitable reinforcements. The doors can be hinged at the side, or at the top and counterbalanced. Many doors are fitted with special mechanisms for rapid closing. Door gaskets should be durable and at the same time provide gastight seal. To a large extent, the efficiency of a chamber depends upon the tightness with which the door or doors will seal. All other chamber openings **must** be equally tight to sustain the prescribed vacuum over a specified period of time.

To permit circulation beneath the load, the chamber **must** be designed to enable the stacking of commodities on pallets, skids, or small trucks. Small chambers that are usually hand loaded have removable floors.

Vacuum Pump

Each installation requires a high quality, high capacity vacuum pump. The vacuum pump should have the capacity to reduce the chamber pressure to 1 to 2 inches (25 to 51 millimeters) of mercury (28 to 29 inches or 711 to 737 millimeters vacuum) in 15 minutes or less.

Fumigant Introduction Systems

The size of the chamber will determine the introduction system needed. For small chambers and for introducing fumigants in small quantities, measure the fumigant by volume using a graduated dispenser. For larger chambers, place the gas supply cylinder on a platform scale and measure the amount of fumigant by weight.

For methyl bromide, a volatilizing unit is required to ensure fumigant introduction in a gaseous state. The volatilizer is located outside of the chamber between the gas cylinder or dispenser and the introduction port of the chamber. Essentially, the volatilizer consists of a metal coil submerged in water hot enough to vaporize the fumigant. The volatilizer **must** maintain the water temperature to at least 150 °F throughout the entire gas introduction period.

Within the chamber, the gas introduction system should consist of tubing with multiple, graduated openings that will provide uniform distribution of the fumigant throughout the length of the chamber. Ensure that the fumigant enters the chamber from multiple points along the ceiling.

Circulation and Exhaust System

Adequate gas distribution is often hindered by the cargo placed in the chamber. To overcome this, equip vacuum chambers with a circulation system. If fans are employed, the number of fans required would depend upon the chamber design, volume, and loading arrangements. A minimum of 2 fans is normally required for chambers of over 1,000 cubic feet capacity (28.31 m³). Place the fans at opposite ends of the chamber facing each other—one high, one low. Additional fans might be required for larger chambers. The fans should be capable of circulating air at the rate of at least one-third the volume of the chamber per minute. Some fumigants require nonsparking, explosion-proof circulation systems.

In most installations, the vacuum pump is used to remove the fumigant following the exposure period. The air-gas mixture is pumped out of the chamber through exhaust ducts or stacks installed for that purpose. The actual height of these stacks will vary with the location of the chamber, and may be regulated by local, state, or federal safety ordinances.

Accessories

Equip chambers with a vacuum gauge and an instrument for measuring and recording the vacuum drawn and maintained during the exposure period. Install a temperature monitoring device in chambers used for quarantine treatments that are 6 hours or more in length. Combination temperature and vacuum recorders are available.

Temperature sensors are usually attached to the outside of the chamber with a remote sensing unit attached to the inside wall or inserted into the product. Specifications for the temperature recording system are as follows:

- ◆ Accurate to within ± 0.6 °C or ± 1.0 °F in the treatment temperature range of 4.4 °C to 26.7 °C (40 °F to 80 °F)
- ◆ Calibrated annually by the National Institute of Standards and Technology (NIST) or by the manufacturer
 - ❖ The calibration certificate will list a correction factor, if needed, and the correction factor would be applied to the actual temperature reading to obtain the true temperature.
- ◆ Capable of printing all temperature readings or downloading data to a secure source once per hour throughout the entire treatment (all temperature data must be accessible at a safe distance during the fumigation)
- ◆ Tamper-proof

If one or more of the temperature readings go below 40 °F the fumigation will be considered a failed treatment. The commodity must be re-treated, returned to the country of origin, reexported, or destroyed.

⚠ CAUTION

Commodities used for food or feed may not be re-treated. If commodities fall into this category, the only options are:

- ◆ Return to the country of origin
- ◆ Reexported to another country if they will accept the shipment
- ◆ Destroy by incineration

Certification Standards

To qualify for program approval, vacuum chambers **must** be able to meet or exceed specified vacuum leakage tests. There are four classification levels in which a chamber may be certified. The tests are listed in [Table 6-2-1](#) and determine the classification under which the chamber qualifies.

NOTICE

There should be **no** commodity in the chamber during the certification procedure.

Table 6-2-1 Vacuum Chamber Classification Table

Classification	Initial Vacuum (inches)	Allowable Vacuum Loss			
		4 hr.	6 hr.	16 hr.	24 hr.
Superior	28 1/2	—	1/2"	—	1"
A	28 1/2	1/2"	—	1"	2"
B	28 1/2	1"	—	2 1/2"	3"
C	26	1"	—	2 1/2"	3"

In addition to the classification tests in [Table 6-2-1](#), **ALL** chambers **must** be capable of meeting the following requirement: A vacuum equivalent to 26 inches (660 mm) of mercury is drawn. The vacuum is then reduced to 5 inches (127 mm) and held for a period of 4 hours. A vacuum of 2 inches (55 mm) or more after 4 hours is considered adequate for this test.

- ◆ Chambers classified “Superior” or “A” are approved for all vacuum treatments. These chambers are to be tested annually.
- ◆ Chambers classified “B” are approved for all vacuum schedules up to and including 28-inch (711 mm) sustained vacuum. These chambers are to be tested semi-annually.
- ◆ Chambers classified “C” are approved for all vacuum schedules up to and including 26-inch (711 mm) sustained vacuum. These chambers are to be tested semi-annually.

During each certification, conduct a preventative maintenance inspection. The maintenance inspection will ensure the merit of each unit and correct any deficiencies prior to certification. Refer to [Table 6-2-2](#) for an inspection checklist.

 **CAUTION**

Never use methyl bromide to check for leaks in the chamber. Use compressed air to check for leaks.

Once the chamber has met the requirements in [Table 6-2-1](#) and passes the preventative maintenance check, the approving APHIS official **must** complete PPQ Form 480 (Treatment Facility Construction, Operation and Test Data), and PPQ Form 482 (Certificate of Approval). A copy of each of the forms should be given to the owner/operator of the chamber and also mailed to:

USDA-APHIS-PPQ-S&T-TMT
13601 Old Cutler Road, Bldg. 63
Miami, FL 33158 USA
Phone: 305-278-4877
Fax: 305-278-4898
email: ppqmt@usda.gov

Approving a chamber for vacuum fumigation does **not** include approving atmospheric (NAP) fumigations. If the vacuum chamber will also be used as a normal atmospheric pressure chamber, it **must** also pass a pressure leakage test (see [Pressure-leakage Test for NAP Fumigation Chambers](#)).

Actual detailed instructions for constructing a vacuum chamber are **not** included in this discussion. The information presented is designed to list the component parts needed and the function of each.

Checklist

Use the checklist in [Table 6-2-2](#) as a guide during chamber certifications..

Table 6-2-2 Chamber Checklist

CHAMBER AND VOLATILIZER	YES	NO
Has chamber been measured and total volume calculated?		
Has chamber been checked for integrity?		
◆ Smoke test		
◆ Pressure test		
Have fans been tested to recirculate at least one third of the total volume per minute?		
Is gas monitoring required (by the workplan)?		
◆ If yes, are sampling leads properly placed (in commodity, if required)?		
◆ Are sampling leads one quarter inch inner diameter and free from blockage?		
Will a scale be used to apply fumigant?		
◆ If yes, has the scale been calibrated and certified this year?		
◆ Is the graduated dispenser in good condition?		
Are the door seals and gaskets in good condition?		
Is the copper tubing in the volatilizer intact? (check for holes)		
Are the vacuum and temperature gages accurate?		
REQUIRED EQUIPMENT		
Tape measure or electronic measuring device		
Calculator		
Stop watch		
Air (leaf) blower with appropriate fittings and adapters		
Manometer (including tubing and appropriate liquid)		
Digital anemometer		
Gas detection device (calibrated within one year)		
Dessicant (Drierite®) and Ascarite®		
Auxiliary pump (for large chambers)		
Digital thermometer (accuracy 0.1 F) with probe		
REQUIRED SAFETY EQUIPMENT		
Gas leak detection device		
Self contained breathing apparatus		
First aid kit, including eye wash		
Emergency medical treatment facility map and phone number		

Table 6-2-2 Chamber Checklist (continued)

REQUIRED DOCUMENTATION		
PPQ Form 480, Treatment Facility		
PPQ Form 482, Certificate of Approval		
Material safety data sheet		
Warning placard (English and Spanish)		
Special local need label and permit (if applicable)		

Certifying Facilities

Certifying Normal Atmospheric Fumigation Chambers

Contents

Construction and Performance Standards	6-3-1
Basic Elements for Design and Construction of Chambers	6-3-3
Pallets and Bins	6-3-3
Gastight Construction	6-3-4
Circulation and Exhaust Systems	6-3-6
Fumigant Dispensing System	6-3-8
Pressure-leakage Test for NAP Fumigation Chambers	6-3-9
Other Auxiliary Equipment	6-3-11
Phosphine Chambers	6-3-11
Checklist	6-3-13

Construction and Performance Standards

The primary purpose of a fumigation program is to obtain quarantine control of the pests in all stages of development in, on, or with the product being fumigated. A fumigation chamber is defined as a stationary enclosure into which the product can be loaded and where fumigant will be maintained at the prescribed concentration for the required exposure period.

When constructing a normal atmospheric (NAP) fumigation chamber, the primary consideration is to make it as gastight as possible. In addition, companies must install circulation equipment in chambers that are to be used for methyl bromide (MB) fumigations to ensure proper distribution of the fumigant throughout the chamber. The chamber **must** retain these qualities of tightness and fumigant circulation during every fumigation.

Although chamber sizes are **not** restricted to specific dimensions, companies should size chambers according to the volume of material to be fumigated. Experience has shown that two moderately sized chambers are preferable to one large chamber.

Chamber manufacturers should select the construction material according to the type of product to be fumigated and the method of operation involved. Wood frame construction with light metal sheathing or plywood can be used if the products to be fumigated are lightweight and are to be hand loaded. Heavy products, often loaded by machinery or handtrucks, require heavy-gauge sheet

metal, masonry, or metal plate construction. It is advisable to construct the chamber in the most durable manner consistent with its intended use.

Auxiliary equipment is required to measure, vaporize, circulate, and exhaust the fumigant. Chamber manufacturers should size such equipment according to the volume of the chamber. When relatively small amounts of MB are to be used, they are often measured by volume in graduated dispensers. When larger amounts are to be used, the fumigant is most often measured by weight with the use of an approved and calibrated measuring scale.

Chambers can be equipped with heating or refrigeration units, depending on the climatic environment and the products to be fumigated. Product injury or an ineffective fumigation can occur within certain temperature ranges. Although provisions for temperature control are **not** generally mandatory, in certain fumigation operations, temperature control is necessary and therefore **must** be considered in the design and construction of fumigation chambers.

While complete construction details for an atmospheric fumigation chamber are **not** contained in this chapter, sufficient information is available to develop specifications for a proposed structure. Firms considering chambers for approval by the USDA must submit a completed fumigation chamber approval application and other required information (e.g. manuals, technical sheets) to their local APHIS-PPQ contact.

Download a fillable Application for USDA Fumigation Facility Approval Form located on the [S&T website](#).

Contact ppqmt@usda.gov with questions regarding the application.

Local APHIS-PPQ personnel will determine the feasibility of constructing the proposed chamber with regards to PPQ resources and requirements. If these are permitted, local personnel will review the submitted application for completeness and forward to the National Operations Manager for Import and Exclusion Treatments.

National Operations Manager for Import and Exclusion Treatments
USDA-APHIS-PPQ
1730 Varsity Drive, Suite 300
Raleigh, NC 27606

The National Operations Manager for Import and Exclusion Treatments will subsequently forward the application to the following office:

USDA-APHIS-PPQ-S&T-TMT
13601 Old Cutler Road, Bldg. 63
Miami, FL 33158 USA
Phone: 305-278-4877
Fax: 305-278-4898
email: ppqmt@usda.gov

Basic Elements for Design and Construction of Chambers

- ◆ Gastight and remains so during every use
- ◆ Provides an efficient system for circulating and exhausting the fumigant
- ◆ Provides an efficient system for dispensing the fumigant
- ◆ Provides heating or refrigeration units when required for fumigation efficiency, to prevent product injury, or to meet label temperature requirements
- ◆ Provides a temperature recording system when treatments are 6 hours or longer in duration
- ◆ Provides suitable fittings to facilitate a pressure-leakage test and gas concentration sampling

The criteria listed above deal primarily with the efficiency of the fumigation chamber itself. In determining the ultimate design and construction, it is essential to give consideration to the safe and practical operation of the facility.

All requirements outlined in this chapter apply to all USDA-approved fumigation chambers that use MB and phosphine, unless specifically noted. See [Phosphine Chambers](#) on page 6-3-11 for additional information specific to phosphine.

Pallets and Bins

All material placed in the chamber must be on pallets or bins. Load pallets and bins in the chamber so that there is at least two inches of space under the commodity and between each pallet or bin. Fumigation of double-stacked commodities has been conducted in some locations, and approval for this practice is granted on an individual basis. The proposed double-stacked configuration must be designed to ensure that safe and effective fumigations are conducted. Prior to chamber certification, take gas concentration readings throughout the fumigated load to demonstrate that even readings can be achieved with the proposed configuration.

Do not fumigate items or combinations of items (e.g., commodity, packaging) that are sorptive or whose sorptive capacities are unknown unless gas readings are taken by an APHIS representative. Take gas readings for each chamber certification and anytime there is a change in commodity, packaging material, increase in chamber load capacity, or changes to the chamber itself (unless the effect of the change is known and will not decrease gas concentrations below required levels.) See [Sorption](#) on page 2-3-10 for additional information on sorption, sorptive materials, and packaging.

Gastight Construction

Interior surfaces **must** be impervious to the fumigant and can be constructed of metal, cement, concrete block, tile, or plywood. Any other material that is to be used on the interior surface of the chamber **must** be approved by PPQ prior to installation. Sorbent materials (e.g., foam, insulation) cannot be installed on the interior surfaces of the chamber, although they can be used in areas that will not be exposed to the fumigant. PPQ does allow the use of foam to seal joints in a phosphine chamber.

Introduction lines, fittings, pipes, exhaust stacks, and other structures that could come into contact with MB should be constructed of the following materials that are compatible with this gas:

- ◆ Brass
- ◆ Copper
- ◆ Carbon steel
- ◆ Stainless steel
- ◆ Polyethylene
- ◆ Polypropylene
- ◆ Polytetrafluoroethylene (PTFE; Teflon[®])

Aluminum and galvanized metal are also acceptable if no liquid MB could come into contact with these materials, although there may be possible reactivity problems with long-term use.

Do not use the following materials for introduction lines, fittings, pipes, or other structures that could come into contact with MB:

- ◆ Natural rubber
- ◆ Nylon
- ◆ Polyvinyl chloride (PVC)
- ◆ Tygon[®] tubing should not be used as gas sampling or introduction lines

Seal joints with appropriate compound, solders, or welds for the construction materials used. When wood or a combination of wood and sheet metal are used, seal all joints and seams with a nonhardening material. This makes a gastight seal and allows for expansion and contraction without leakage. Use mastic tape to seal the seams between wall joints in plywood chambers. In masonry construction, joint (strike) the mortar between all courses of cement blocks to produce a smooth, compact surface. Poured concrete structures should also have smooth, compact surfaces. Weld all metal joints.

Fit all doors and vents with proper gaskets. PPQ recommends that chamber operators replace all door and vent door gaskets (regardless of construction material) once per season in chambers that receive moderate use. In chambers that receive heavier use (e.g., fumigations performed several times per week for an entire season), it is recommended that the gaskets be replaced more frequently.

The following list of materials are compatible with MB and can be used as construction material for gaskets:

- ◆ Fluoroelastomer (FKM) (for example, Dupont™ Viton®)
- ◆ Ethylene Propylene Diene Monomer (EPDM) (acceptable even though chemical compatibility charts indicate that it should not be exposed to MB; inspect regularly for damage and replace when needed)
- ◆ Neoprene (acceptable even though chemical compatibility charts indicate that it should not be exposed to MB; inspect regularly for damage and replace when needed)
- ◆ Nitrile (Buna-N)
- ◆ Silicone
- ◆ Polytetrafluoroethylene (PTFE; Teflon®)

Ensure that all openings for wiring, thermometers, tubing, and ports for pressure-leakage tests, etc. are gastight. PPQ requires a minimum of three fittings to be installed in each chamber for measuring gas concentration. Additional fittings may be required in certain circumstances, such as large chambers or chambers in which the commodity will be double-stacked.

Paint interior surfaces (except for metal) with epoxy resin, vinyl plastic, or asphalt base paints. Additional paint types may be approved if the manufacturer's specifications show compatibility of the paint with the fumigant to be used. Such paint coverings make the surfaces less sorptive, an important factor in maintaining gas concentrations. Although not mandatory, many fumigation chamber operators install concrete bumpers on the floor around the sides of the chamber to prevent forklift damage to the walls.

NOTICE

Aluminum base paints are **not** acceptable because of the corrosive effect caused by a reaction between such paints and the fumigant.

The construction and fastening of chamber doors is most critical to the chamber's ability to hold the gas. Chamber doors can be mounted using hinges, sliding rails, cantilevers, etc., and can be tightened against the associated gasket with turnscrews, hydraulic rams, clamps, etc. Approval will be based on review of the individual system. PPQ does note that small guillotine-style doors are less likely to leak than many other door types and chamber doors that are hinged at the top are less likely to sag than those hinged at the side. Heavy-duty or industrial hinges are required for doors that are hinged at the side. Regardless of the method used to mount and fasten the doors, it is important that a high-quality gasket is installed around the entire perimeter of the chamber opening. To obtain the maximum seal possible, uniformly and tightly compress the doors against the gaskets.

Circulation and Exhaust Systems

Fans or blowers delivering the prescribed minimum air movement are essential to proper fumigant distribution.

Various methods can be used to circulate the fumigant within the chamber. Equipment should be capable of circulating air at the rate of at least one-third the volume of the chamber per minute. A minimum of two fans is required for chambers greater than 1,000 cubic feet, although this requirement may be waived by local APHIS-PPQ personnel on an individual basis, i.e., when one fan can be shown to achieve adequate and uniform gas concentrations throughout the fumigated load. Position the fans in one of these three configurations:

- ◆ at opposite ends of the chamber, facing each other—one high and one low
- ◆ all mounted high on one wall of the chamber
- ◆ one fan is placed at the top and one at the bottom of a duct or enclosed space

Local APHIS-PPQ personnel may also approve chamber setups resembling precoolers. In this arrangement, two rows of pallets are positioned with approximately a two-foot tunnel in between them and a large fan (that meets minimum air flow requirements) at the front that pulls the fumigant through the pallets and redistributes it above the pallets into the room. In some cases, this setup may utilize a second fan which can both facilitate the circulation of the air/gas mixture and serve as the exhaust fan during aeration.

Ductwork is recommended for larger chambers, especially those that are long and narrow. It serves to pick up the air/gas mixture near the floor and blow it across the top of the load.

Additional fans might be required in certain cases (e.g., larger chambers, chambers in which the commodities are double-stacked, chambers without ductwork or return fans.) A blower located outside the chamber can also be used, but this method increases the possibility of leakage considerably.

NOTICE

Deviations from these guidelines may be permissible but will require additional testing to ensure efficacy.

The exhaust fan(s) must be capable of a minimum of ten air exchanges per hour. The sum of cubic feet per minute (cfm) of the exhaust fan(s) or exhaust blower divided by the volume of enclosure (in cubic feet), and multiplying the fraction by 60, equals the number of complete gas volume exchanges per hour.

Refer to [Figure 6-3-1](#) and the associated example for the formula for calculating the air exchange rate (AER).

$$AER = \frac{\text{Sum CFM of all exhaust fans} \left(\frac{\text{cubic feet}}{\text{min}} \right)}{\text{Volume enclosure (cubic feet)}} 60 = \frac{\text{Air Exchanges}}{h}$$

Figure 6-3-1 Formula to Calculate Air Exchange Rate (AER)

EXAMPLE

$$AER = \frac{(6,000 + 9,000) \left(\frac{\text{cubic feet}}{\text{min}} \right)}{50,000 \text{ (cubic feet)}} 60 = \frac{18 \text{ Air Exchanges}}{h}$$

Size exhaust blowers according to the volume of the chamber.

APHIS PPQ requires a minimum of four gas exchanges per hour during aeration, although fifteen or higher is preferable, especially for perishable commodities. The quality of perishable commodities may be impacted even at or around the minimum required aeration rate of four gas exchanges per hour. If the exhaust flow is connected to a MB recovery system, it must not impede the flow rate to less than four volumes per hour. Frequently, circulation and exhaust systems are designed to utilize the same blower. Extend the exhaust stack at least 15 feet above all nearby structures. Local air quality control agencies may require more stringent measures. It is essential that the air/gas mixture is vented to the outside, with all local safety ordinances being followed.

Fumigant Dispensing System

The dispensing system needed will vary with the type of fumigant being used. The fumigant MB is usually introduced into the chamber through an introduction line extending from the volatilizer to the air stream in front of the introduction fan. Within the chamber, this tube should contain properly spaced openings through which the fumigant is dispersed.

Ensure that no liquid MB comes into contact with the commodity by one of the following methods:

- ◆ Placing a piece of impermeable sheeting (e.g., plastic or rubberized canvas) over the commodity below and to the front of each gas introduction line
- ◆ Placing a drip pan wherever the gas is introduced into the chamber
- ◆ Using a gas introduction line with holes in the sides but solid on the bottom

Graduated dispensers are used to measure small quantities of MB by volume and generally should not be used to introduce fumigant into chambers larger than 2,000 cubic feet. Place the dispenser in the introduction line between the supply cylinder and the volatilizer. For larger quantities of fumigant, place the supply cylinder on a platform scale and weigh the fumigant used. The measured amount of fumigant must pass through a volatilizer where it is converted from a liquid to a vapor.

The volatilizer consists of a metal coil submerged in heated water. When 5 pounds or less of MB are used, a simple volatilizer can be made with a 25-foot coil of 3/8 inch outer diameter coiled copper tubing immersed in a container of hot water. When amounts greater than 5 pounds are to be used, the copper tubing used in the volatilizer must consist of a minimum of 50 feet of 1/2 inch outer diameter coiled copper tubing. Volatilizers constructed as sealed metal units, in which there is no way to verify the amount or type of tubing inside, should be replaced at the discretion of local APHIS-PPQ personnel. The water in the volatilizer must reach 200 °F or above with a minimum temperature of 150 °F during gas introduction. The fumigator must provide local PPQ personnel with a record of the temperature of the water in the volatilizer both at the beginning and the end of gas introduction.

NOTICE

You are **not** required to record the temperature of the water in the volatilizer on the PPQ Form 429B or in the electronic 429 database.

The line that runs from the methyl bromide cylinder to the copper tubing in the volatilizer must be a 3000 PSI hydraulic high pressure hose (preferably steel-braided) with a 3/8 inch or larger inner diameter. The line that exits the

volatilizer and runs into the enclosure must be a 350 PSI tubing with a ½ inch or greater inner diameter. The chamber operator may wish to install either a pressure release trap (i.e., burp tube) or pull a slight vacuum in the chamber prior to dispensing the fumigant to mitigate against the increased pressure accompanying gas introduction, although neither of these recommendations is mandatory.

The maximum rate of fumigant introduction from a gas introduction line is 4 pounds of gas per minute, unless the fumigator can demonstrate that a faster rate of introduction would not result in the temperature of the water in the volatilizer falling below 150 °F anytime during the entire gas introduction process. This temperature requirement is necessary to ensure that no MB can be introduced as a liquid into the chamber. Purge all gas introduction lines with either compressed air or nitrogen after gas introduction.

Calibrate both the scale and the thermometer on the volatilizer annually, although the latter may instead be replaced annually with a thermometer that comes with a certificate of calibration. Written documentation of calibration must be present at the time of fumigation. All calibrations must be performed by the appropriate state governmental department of weights and measures, the National Institute of Standards and Technology (NIST), or an approved calibration company.

Pressure-leakage Test for NAP Fumigation Chambers

Before a chamber is used for fumigation, it must be checked for tightness using a pressure-leakage test. The chamber must pass this test to be certified. The certifier may also perform a smoke candle test to identify the location of any leaks which could pose safety hazards during fumigation, especially if the retention time is low during the pressure-leakage test or the certifier suspects leakage. This will allow the operator the opportunity to correct these spots before any MB is introduced into the chamber, thus minimizing the likelihood of human exposure to the fumigant.

Conduct the pressure-leakage test using an open-arm or electronic manometer. See [Open-Arm Manometer](#) on page 8-1-19 for a detailed description of this type of manometer. Refer to [Appendix E](#) for a list of approved manometers.

The procedure for conducting a pressure-leakage test is as follows:

1. Install an opening (usually 2- inches in diameter) in the chamber to which a blower or other device for introducing air can be attached.
2. Attach a 2-inch ball-valve between the opening (pipe fitting) and the blower. This will stop the flow of air when the chamber has reached pressure and prevent the air from venting out of that opening.

3. Install an additional opening, such as a gas sampling line opening, for the manometer. This opening should be located within 15 inches of the hole for the blower. Both openings should be situated approximately 4 to 5 feet from the floor, so readings can easily be taken.
4. Close chamber as for fumigation.
5. Attach one end of the manometer to the chamber opening.
6. Pressurize the chamber using a blower (or other device that blows high volumes of air) to a total pressure of 25 mm (12.5 mm in each arm of the manometer) for chambers constructed partially or entirely of plywood or 50 mm for chambers constructed of materials such as cement or cinder blocks.
7. Discontinue blower and close its opening.
8. Observe time for pressure to recede.

For a chamber constructed of materials, such as cement or cinder blocks, the time lapse for the chamber pressure to recede from 25 mm to 2.5 mm in **each** arm of the manometer **must** be:

- ❖ 22 to 29 seconds; reinspect chambers every 6 months
- ❖ 30 seconds or longer; reinspect chambers annually

For plywood chambers, the time lapse for the chamber pressure to recede from 12.5 mm to 1.25 mm in each arm **must** be:

- ❖ 60 seconds or longer; reinspect chambers annually

During each certification, PPQ **must** conduct a preventative maintenance inspection. The maintenance inspection will ensure the merit of each unit and correct any deficiencies prior to certification. Refer to [Table 6-3-1](#) for an inspection checklist.

Once the chamber has passed the pressure-leakage test and the preventative maintenance check, the approving APHIS official **must** complete PPQ Form 480 (Treatment Facility Construction, Operation and Test Data), and PPQ Form 482 (Certificate of Approval). Give a copy of each of the forms to the owner/operator of the chamber and mail to:

USDA-APHIS-PPQ-S&T-TMT
13601 Old Cutler Road, Bldg. 63
Miami, FL 33158 USA
Phone: 305-278-4877
Fax: 305-278-4898
email: ppqtmt@usda.gov

Other Auxiliary Equipment

For chambers located inside a building, USDA requires that low-level gas monitoring devices be installed in the same room as the fumigation chamber. Multiple monitors may be necessary depending on the configuration of the facility.

According to the needs of the operation, other auxiliary equipment may be necessary. When heat is required, steam pipes or low-temperature electric strip heaters are generally recommended. Do **not** use open flame or exposed electric coils as they tend to break down the gas and form undesirable compounds. Size refrigeration units to the volume of the chamber and the type and amount of commodity involved.

Install a temperature monitoring device in chambers used for quarantine treatments that are six hours or more in duration. Temperature recording thermometers are usually attached to the outside of the chamber with a remote sensing unit attached to the inside wall or inserted into the product.

Specifications for the temperature recording system are:

- ◆ Accurate to within ± 0.6 °C or ± 1.0 °F in the treatment temperature range of 4.4 °C to 26.7 °C (40 °F to 80 °F)
- ◆ Calibrated annually by the National Institute of Standards and Technology (NIST) or by the manufacturer
 - ❖ The calibration certificate will list a correction factor, if needed, and the correction factor would be applied to the actual temperature reading to obtain the true temperature.
- ◆ Capable of printing all temperature readings or downloading data to a secure source once per hour throughout the entire treatment (all temperature data must be accessible at a safe distance during the fumigation)
- ◆ Tamper-proof

Phosphine Chambers

Phosphine can react with certain metals (e.g., gold, silver, copper, brass, and other copper alloys) and cause corrosion, especially at higher temperatures and relative humidities. Fans, blowers, and tubing should not be constructed from these or any other materials, such as urethane or other rubber, that are not resistant to phosphine. It is recommended that all wiring be external to the chamber, but is required (at a minimum) that all wiring, electrical and exhaust systems be non-sparking and explosion proof.

All gas dispensing equipment used with cylinderized formulations of phosphine must be approved by the registrant. VAPORPH3OS can only be introduced via Cyttec-approved blending equipment. ECO2FUME must be

introduced via stainless steel or hydraulic dispensing lines of suitable pressure rating and materials of construction, as determined by Cytec. Heat sources are generally not used or necessary in phosphine introduction, although some methods of cylinderized phosphine introduction may use electric vaporizers. Contact the registrant for additional information on this issue. Circulation fans are not needed in phosphine chambers.

Checklist

Use the checklist in [Table 6-3-1](#) as a guide during chamber certifications.

Table 6-3-1 Chamber Checklist

Chamber and Volatilizer	Yes	No
Has chamber been measured and total volume calculated, including all areas where the fumigant penetrates (for example, ductwork)?		
Has chamber been checked for integrity?		
◆ Smoke test		
◆ Pressure test		
Have fans been tested to recirculate at least 1/3 of the total volume per minute?		
Can gas monitoring be adequately performed?		
◆ Are sampling leads properly placed?		
◆ Are sampling leads 1/4 inch inner diameter polyethylene or polypropylene and free from blockage?		
Will a scale be used to apply fumigant?		
◆ If yes, has the scale been calibrated and certified this year?		
◆ If no, Is the graduated dispenser in good condition?		
Are the door seals and gaskets in good condition?		
Is the copper tubing in the volatilizer intact? (check for holes, if possible)		
Is the temperature gauge accurate and has it been calibrated within one year?		
Required Equipment and Documentation		
Tape measure or electronic measuring device		
Calculator		
Stop watch		
Air (leaf) blower with appropriate fittings and adapters		
Manometer (including tubing and appropriate liquid)		
Digital anemometer		
Gas detection device (calibrated within 1 year)		
Dessicant (Drierite [®]) and Ascarite [®]		
Auxiliary pump (for large chambers)		
Digital thermometer (accuracy 0.1 °F) with probe		
Smoke candles		
Gas leak detection device		
Self contained breathing apparatus (SCBA)		
First aid kit, including eye wash		
Emergency medical treatment facility map and phone number		
PPQ Form 480, Treatment Facility Construction, Operation, and Test Data		
PPQ Form 482, Certificate of Approval		
Safety data sheet (SDS)		
Warning placard (English and Spanish)		
Special local need label and permit (if applicable)		

Certifying Facilities

Certification of Cold Treatment

Contents

Introduction	6-4-1
Standards for Temperature Recording Systems	6-4-2
Temperature Recording System	6-4-2
Temperature Sensors	6-4-3
Remote Data Transmission (RDT) Systems	6-4-3
Certification of Vessels Used for In-Transit Cold Treatment	6-4-5
Plan and Specification Approval	6-4-5
Certification Testing	6-4-6
Documentation	6-4-7
Certificate of Approval	6-4-8
Application for USDA Vessel Approval	6-4-9
Certification of Self-Refrigerated Containers Used for In-Transit Cold Treatment	6-4-9
Certification Requirements	6-4-9
Letter of Certification	6-4-9
Application for USDA Container Certification	6-4-10
Certification of Warehouses Used for Cold Treatment	6-4-10
Plan and Specification Approval	6-4-10
Certification Testing	6-4-11
Application for USDA Warehouse Approval	6-4-12
Calibration of Temperature Sensors	6-4-12
Contact Information	6-4-14
USDA-APHIS-PPQ-S&T-TMT	6-4-14

Introduction

Since the early 1900s, sustained cold temperature has been employed as an effective post-harvest method for the control of the Mediterranean and certain other tropical fruit flies. Exposing infested fruit to temperatures of 2.2 °C (36 °F) or below for specific periods of time results in the mortality of the various life stages of this group of notoriously injurious insects. Procedures were developed to effectively apply cold treatment (CT) to fruit while in transport in refrigerated holds of ships, in refrigerated containers, and in warehouses located in the country of origin or in the United States.

Self-refrigerated (integral) containers, conventional vessels, and warehouses utilized for regulatory cold treatment are subject to approval by the USDA.

Approval is needed only when treating fruit under USDA regulations and does **not** constitute an endorsement for the carrying or storage of refrigerated cargo.

Only officials authorized by APHIS have permission to conduct warehouse, vessel, or container certification under the general guidance of S&T-TMT. Refer to the S&T-TMT [website](#) for a complete list of USDA-certified vessels and containers for in-transit cold treatment.

Standards for Temperature Recording Systems

Temperature recording systems may consist of various electronic components such as temperature sensors, computers, printers, and cables, and are required for temperature recording installations in cold treatment vessels, refrigerated containers, or warehouses. Submit plans and specifications of the temperature recording system to [USDA-APHIS-PPQ-S&T-TMT](#) for review and approval before installation.

Temperature Recording System

- ◆ **Accuracy**—The accuracy of the system **must** be within plus or minus 0.3 °C (0.5 °F) of the true temperature in the range of minus 3 °C (27 °F) to plus 3 °C (37 °F).
 - ❖ Ensure the instrument is capable of repeatability in the range of minus 3 °C to plus 3 °C (27 °F to 37 °F).
- ◆ **Automatic Operation**—The system **must** be capable of automatic operation whenever the treatment system is activated.
- ◆ **Long-Term Recording**—The system **must** be capable of continuous recording of date, time, sensor number, and temperature during all calibrations and for the duration of a voyage and/or treatment period.
- ◆ **Password Protection**—All approved temperature recording devices **must** be password protected and tamper proof.
- ◆ **Range**—The recorder **must** be programmed to cover the entire range between minus 3 °C to plus 3 °C (27 °F to 37 °F), with a resolution of 0.1 (°C or °F).
- ◆ **Recording Frequency**—The time interval between prints will be **no** less than **once every hour**. For each sensor, the temperature value, location/identification, time, and date **must** print **once per hour**.
- ◆ **Repeatability**—When used under treatment conditions over an extended period of time, the system **must** be capable of repeatability in the range of minus 3 °C to plus 3 °C (27 °F to 37 °F). The design, construction, and materials **must** be such that the typical environmental conditions (including vibration) will **not** affect performance.

- ◆ **Visual Display**—The system **must** have a visual display so the temperature can be reviewed manually during the treatment and calibrations.

Temperature Sensors

- ◆ **Construction Standards**—Sensors should have an outer sheath diameter of 0.25 inches (6.4 millimeters) or less. The sensing unit **must** be in the first inch of the sensor.
- ◆ **Identification**—Identify all sensors to distinguish the sensors in one compartment from those in other compartments.
 - ❖ Place an identifying number on the box where the sensor originates and on a permanent tag where the cable joins the sensor.
 - ❖ Identify the sensors for each compartment so the air sensors are numbered first (e.g., A1, A2—air; A3, A4,....,etc.,—fruit pulp).
- ◆ **Location**—Post a diagram next to the recording instrument that shows the location and identification of each sensor by compartment.
 - ❖ Air sensors—Place sensors on the center line of the vessel, fore and aft, approximately 30 centimeters from the ceiling and connected to cables at least 3 meters in length
 - ❖ Fruit sensors—Distribute fruit sensors throughout the compartment so all areas of the compartment can be reached (5- to 15-meter cable lengths are usually sufficient). The number and location is dependent upon cubic capacity of the compartment. Refer to [Table 6-4-1](#) on page 6-4-6 for guidance for vessels and [Table 6-4-2](#) on page 6-4-11 for guidance for warehouses. Three temperature sensors are required for refrigerated containers. These are labeled USDA1, USDA2, and USDA3.

Contact [USDA-APHIS-PPQ-S&T-TMT](#) for a complete list of approved temperature recording systems.

Remote Data Transmission (RDT) Systems

RDT systems communicate wirelessly via cellular or satellite connections with refrigerated container temperature controllers to monitor the temperature of commodities undergoing in-transit cold treatments. When connected to the communications grid, cold treatment data logs containing recorded data from the temperature controller's memory are downloadable. Data records are currently output to Commodity Treatment Information System (CTIS) 556 In-Transit Cold Treatment database (<https://coldtreatment.cphst.org>) in XML format.

NOTICE

RDT systems are currently **only** approved for use in refrigerated containers.

Refer to [Appendix E](#) for a list of approved RDT systems.

Requirements for RDT Systems

RDT systems must be approved by [USDA-APHIS-PPQ-S&T-TMT](#) before they can be used in APHIS-approved cold treatments. Before requesting APHIS approval for RDT systems, the system must meet the following requirements:

1. Compatible with a USDA-approved refrigerated container temperature controller. The system **must** transmit temperature data retrieved directly from the USDA-approved controller/recorder built into the refrigerated container. The RDT system **cannot** use a separate or additional recorder.
2. Complete a minimum of 30 cold treatment trials of randomly selected commodity shipments. Trials **must** result in:
 - A. successful passing of the cold treatment schedule for the commodity shipped
 - B. successful RDT data matches with the USDA-approved temperature controller data
 - C. successful upload of RDT data to the CTIS 556 In-Transit Cold Treatment test database
3. Complete a 3-month operational field implementation with details discussed between the manufacturer and [USDA-APHIS-PPQ-S&T-TMT](#). The implementation phase consists of a successful passing of a minimum of 30 randomly selected RDT cold treatment data logs (minimum of 10 data logs per month) that:
 - A. are identical to the data downloaded manually from the USDA-approved refrigerated container temperature controller
 - B. are successfully uploaded to the CTIS 556 In-Transit Cold Treatment database (<https://coldtreatment.cphst.org>) in XML format.
 - C. successfully pass the cold treatment for the commodity being shipped

[USDA-APHIS-PPQ-S&T-TMT](#) **must** also receive the most current technical brochure from the manufacturer.

Contact [USDA-APHIS-PPQ-S&T-TMT](#) for additional information.

Certification of Vessels Used for In-Transit Cold Treatment

Vessels used in cold treatment **must** be certified by a qualified APHIS-PPQ employee or a designated representative before treating fruit under USDA regulations. Refrigeration (reefer) vessels presented for approval **must** be classified under the rules of the American Bureau of Shipping or a comparable internationally recognized ship classification society.

Submit plans, drawings, and specifications to [USDA-APHIS-PPQ-S&T-TMT](#) prior to the first vessel certification. Conduct certification tests prior to the vessel receiving final approval to conduct a cold treatment. Certification will be performed every 3 years or sooner if APHIS determines that a malfunction or alteration of the system warrants a recertification.

Plan and Specification Approval

Prior to the start of vessel construction, an application for vessel approval, detailed drawings of the vessel's physical characteristics, and a written description of all the equipment related to treatment **must** be reviewed and approved by [USDA-APHIS-PPQ-S&T-TMT](#). Submit all plans and supporting materials in Standard English.

Plans and specifications must include the following information:

- ◆ Completed [Application for USDA Vessel Approval](#)
- ◆ Drawings showing the dimensions of the refrigerated compartments
- ◆ Example of an hourly printout from the recording system (must include date, time, temperature unit, vessel name)
- ◆ Number and location of air and pulp sensors in each compartment (see [Table 6-4-1](#) on page 6-4-6)
- ◆ Specifications of the recording system
- ◆ Specifications of refrigeration equipment (including air circulation)

The review of plans and process descriptions may take up to 60 days and subsequent requests for additional information may further extend this time.

Vessel owners will receive a letter granting plan approval or describing plan deficiencies and necessary remedial measures.

Following plan approval, build the vessel according to the plans. If deviations from the plans are necessary, [USDA-APHIS-PPQ-S&T-TMT](#) **must** approve the changes. Submit changes in a manner similar to a new construction application.

Certification Testing

Make the vessel available for an on-site certification visit by a PPQ official when all documents and a completed application have been submitted and approved by the [USDA-APHIS-PPQ-S&T-TMT](#).

NOTICE

Do **not** conduct vessel certification if temperatures in the vessel holds are lower than -1.0 °C (plus or minus 0.3 °C) or 30.2 °F (plus or minus 0.5 °F).

Contact the State Plant Health Director or Officer-in-Charge at the port of call to arrange vessel certification at a U.S. port.

Establish a cooperative agreement and other arrangements as needed with USDA for vessel certification inspections made at a foreign location. This will require a 60-day notification before the inspection can be scheduled. For specific information on the required procedure, contact:

USDA-APHIS-PPQ
 Preclearance and Offshore Programs
 4700 River Road, Unit 67
 Riverdale, MD 20737
 Phone: (301) 851-2162

A representative from the temperature recorder company who is familiar with the installation should be on hand to correct any deficiencies in the system.

Before requesting final inspection, the vessel’s owner **must** complete all arrangements. Calibration and identification tests will be made during the inspection. Refer to [Calibration of Temperature Sensors](#) for calibration procedures for all temperature sensors.

Determining the Number of Temperature Sensors

The number and location of temperature sensors is based on the cubic capacity of the compartment. Refer to [Table 6-4-1](#) to determine the number and location of sensors. Always place the **air** sensors on the fore and aft bulkheads. Always distribute the **pulp** sensors throughout the compartment so that all areas can be reached.

Table 6-4-1 Number of Temperature Sensors per Compartment

Cubic Feet	Cubic Meters	Number of Air Sensors ¹	Number of Pulp Sensors	Total Number of Sensors
0 - 10,000	0 - 283	2 or 3	2	4 or 5
10,001 - 15,000	284 - 425	2 or 3	3	5 or 6
15,001 - 25,000	426 - 708	2 or 3	4	6 or 7

Table 6-4-1 Number of Temperature Sensors per Compartment

Cubic Feet	Cubic Meters	Number of Air Sensors ¹	Number of Pulp Sensors	Total Number of Sensors
25,001 - 45,000	709 - 1,274	2 or 3	5	7 or 8
45,000 - 70,000	1,275 - 1,980	2 or 3	6	8 or 9
70,001 - 100,000	1,981 - 2,830	2 or 3	8	10 or 11
> 100,000	>2,830	Contact S&T-TMT		

1 In the case of twin deck compartments, two air sensors are required in the upper deck plus one air sensor in the lower compartment. This sensor should be located on the bulkhead farthest from the cooling unit.

NOTICE

It is highly recommended that more temperature sensors be installed than the minimum number required for each refrigerated compartment. If a sensor malfunctions during a treatment, the Port Director has the option of disregarding it, providing that an additional working sensor is present, and the functional sensors were uniformly distributed. Otherwise, the entire treatment **must** be repeated for the fruit in that compartment.

Designate two of the sensors as air sensors, and the others as pulp sensors. Any sensors above the required minimum may be either pulp or air sensors.

For compartments exceeding 100,000 cubic feet, contact the [USDA-APHIS-PPQ-S&T-TMT](#) for the minimum number of required sensors.

Frequency of Certification Testing

A certification test is required every 3 years. **No** extensions to this 3 year requirement will be granted. Make requests for renewal at least 60 days before expiration to the S&T-TMT or USDA-PPQ Preclearance Programs. Certification testing is also required any time a malfunction, breakdown, or other failure occurs (excluding temperature sensors) that requires modifications to the recording and monitoring system(s).

Documentation

The APHIS official will document all tests during certification. For final approval, email a copy of the signed PPQ Form 449—R, Temperature Recording Calibration Report, copies of all charts and/or printouts, and any other pertinent addenda or appendices to ppqctis@aphis.usda.gov.

Certificate of Approval

Upon meeting all requirements, the vessel will be designated as approved to conduct in-transit cold treatments under the provisions of the PPQ Fruit and Vegetable Quarantine 56. A PPQ Form 482—Certificate of Approval, listing the approved refrigerated compartments will be issued to the vessel. This approval is for equipment **only**, and each consignment of fruit **must** satisfy all requirements as described in Sections 319.56 and 305.6 of the Code of Federal Regulations as a condition of entry into the United States.

Application for USDA Vessel Approval

Download a [fillable Application for USDA Vessel Approval](#).

Contact ppqmt@usda.gov with questions regarding the application.

Certification of Self-Refrigerated Containers Used for In-Transit Cold Treatment

Certify refrigerated containers used as cold treatment facilities before carrying treated fruit under USDA regulations. Classify refrigerated containers under the rules of the American Bureau of Shipping or a comparable internationally recognized classification society.

Certification Requirements

Download and complete an [Application for USDA Container Certification](#).

Submit the completed application to ppqtis@usda.gov. Submit all plans and supporting materials in Standard English.

Include the following specifications in the application:

- ◆ Air flow rate
- ◆ Container size
- ◆ Make and model of refrigeration unit
- ◆ Make and model of temperature recorder/control unit
- ◆ Type of sensor
 - ❖ At least three sensors are necessary for each container and **must** be labeled USDA1, USDA2, and USDA3

Letter of Certification

Upon meeting all requirements, the container(s) will be certified to conduct in-transit cold treatments under the provisions of the PPQ Fruit and Vegetable Quarantine 56. A Letter of Certification listing the refrigerated container(s) will be issued to the owner. This certification is for container(s) **only**, and each consignment of fruit **must** satisfy all requirements as described in Sections 319.56 and 305.6 of the Code of Federal Regulations as a condition of entry for importation into the United States.

Application for USDA Container Certification

Download a [fillable Application for USDA Container Certification](#).

Contact ppqetis@usda.gov for any questions regarding the application.

Certification of Warehouses Used for Cold Treatment

The local APHIS-PPQ inspector will certify refrigerated warehouses for use as cold treatment facilities before treating fruit under USDA regulations. In addition to the general requirements, warehouse approval is subject to specific geographical pest-risk considerations as outlined in Title 7, Section 305.6 of the Code of Federal Regulations.

[USDA-APHIS-PPQ-S&T-TMT](#) will approve plans and specifications prior to the initial warehouse certification. Conduct a performance survey prior to the warehouse receiving approval to conduct cold treatments under USDA regulations.

Plan and Specification Approval

Prior to the start of warehouse construction, submit a completed [Application for USDA Warehouse Approval](#), detailed drawings of the physical characteristics, and a written description of all the treatment related equipment to [USDA-APHIS-PPQ-S&T-TMT](#). Submit all plans and supporting materials in Standard English.

Include the following information in the application:

- ◆ Address of the warehouse location
- ◆ Drawings showing the dimensions, cubic capacity, and door locations

NOTICE

Drawings may be hand-drawn, but **must** clearly show location of refrigeration units, circulation fans, temperature recorder, and sensors.

- ◆ Make and model of the refrigeration equipment
- ◆ Method for segregating fruit under treatment and securing it from other foreign or domestic articles
- ◆ Name and address of the firm owning the warehouse chamber
- ◆ Number and location of sensors (see [Table 6-4-2](#) on page 6-4-11)
- ◆ Specification of the air circulation system; must indicate the number of air changes and direction of air flow
- ◆ Specifications of the recording system

Certification Testing

When all documents and a completed application have been submitted and approved by the [USDA-APHIS-PPQ-S&T-TMT](#), the warehouse owner should make the warehouse available for an on-site certification visit by a local PPQ official. To arrange warehouse certification, contact the State Plant Health Director or Officer-in-Charge for the port. Before requesting final inspection, the warehouse owner must complete all arrangements as directed by the PPQ officer. The PPQ official will conduct calibration and identification tests during the inspection.

Refer to [Calibration of Temperature Sensors](#) for calibration procedures for all temperature sensors.

Determining the Number of Temperature Sensors

The number and location of temperature sensors is based on the cubic capacity. Refer to [Table 6-4-2](#) to determine the number and location of sensors. The minimum requirement is three sensors—one air sensor and two pulp sensors. Sensor cables must be long enough to reach all areas of the load.

Table 6-4-2 Number of Temperature Sensors in a Warehouse

Cubic Feet	Cubic Meters	Number of Pallets	Number of Air Sensors	Number of Pulp Sensors	Total Number of Sensors
0 - 10,000	0 - 283	1 - 100	1	2	3
10,001 - 20,000	284 - 566	101 - 200	1	3	4
20,001 - 30,000	567 - 849	201 - 300	1	4	5
30,001 - 40,000	850 - 1132	301 - 400	1	5	6
40,001 - 50,000	1133 - 1415	401 - 500	1	6	7
50,001 - 60,000	1416 - 1698	501 - 600	1	7	8
60,001 - 70,000	1699 - 1981	601 - 700	1	8	9
70,001 - 80,000	1982 - 2264	701 - 800	1	9	10
80,001 - 90,000	2265 - 2547	801 - 900	1	10	11
90,001 - 100,000	2548 - 2830	901 - 1000	1	11	12
> 100,000	>2830	1000+	Must be approved by S&T-TMT		

NOTICE

If a refrigerated room is equipped according to the cubic capacity of the storage area (rather than of the load itself), the same criteria apply.

It is highly recommended that additional sensors beyond the required minimum be installed.

Frequency of Certification Testing

A certification test is required every year. Submit requests for recertification to the local PPQ office at least 60 days before expiration. Certification testing is also required any time a malfunction, breakdown, or other failure occurs (excluding temperature sensors) that requires modifications to the recording and monitoring system(s).

Application for USDA Warehouse Approval

Download a [fillable Application for USDA Warehouse Approval](#).

Contact ppqmt@usda.gov with questions regarding the application.

Calibration of Temperature Sensors

Calibrate all temperature sensors using a clean freshwater ice water slurry at 0 °C (32 °F).

NOTICE

It is APHIS policy to use the standard “rounding rule.” In determining calibration factors, if the reading is 0.05 or higher, round to the next higher number in tenths. If it is 0.04 or lower, round to the lower number. For example: If the calibration factor was 0.15, round to 0.2. If it was 0.32, round to 0.3. Similar rounding can be used in actual treatment readings. If an actual reading was 34.04, round to 34.0, add or subtract the calibration factor, if necessary. If it was 34.07, round to 34.1, add or subtract the calibration factor, if necessary.

Use the following steps to make the ice water slurry:

1. Check individual sensors to verify that they are properly labeled and correctly connected to the temperature recorder. This can be accomplished by hand warming each sensor when its’ number appears on the visual display panel of the recording instrument. A temperature change, observed on the instrument, should occur. If the instrument fails to react, the sensor is incorrectly connected or malfunctioning and should be corrected by the instrument representative.
2. Prepare a mixture of clean ice and fresh water in a clean insulated container.

3. Crush or chip the ice and completely fill the container.
4. Add enough water to stir the mixture.
5. Stir the ice and water for a minimum of 2 minutes to ensure the water is completely cooled and good mixing has occurred.
 - ❖ The percentage of ice is estimated at 80 to 85 percent while the water fills the air voids (15 to 20 percent).
6. Add more ice as the ice melts.
7. Prepare and stir the ice water slurry to maintain a temperature of 0 °C (32 °F).
8. Submerge the sensors in the ice water slurry **without** touching the sides or bottom of the container.
9. Stir the mixture.
10. Continue testing of each sensor in the ice water slurry until the temperature reading stabilizes.
11. Record two consecutive readings of the stabilized temperature on the temperature chart or log sheet.
 - ❖ The temperature recording device should be in manual mode to provide an instantaneous readout.
12. Allow at least a 1-minute interval between two consecutive readings for any one sensor; however the interval should **not** exceed 5 minutes.
 - ❖ The variance between the two readings should **not** exceed 0.1 °.
13. Contact an instrument company representative immediately if the time interval exceeds the normal amount of time required to verify the reading and accuracy of the sensor and recorder system.
 - ❖ The recorder used with the sensors **must** be capable of printing or displaying on demand and **not** just at hourly intervals.
14. Correct any deficiencies in the equipment before certification.
15. Replace any sensor that reads more than plus or minus 0.3 °C (0.5 °F) from the standard 0 °C (32 °F).
16. Replace and recalibrate any sensors that malfunction.
17. Document the recalibration and replacement of the sensor(s) on the PPQ Form 449-R, Temperature Recording Calibration Report.
18. Determine the calibrations to the nearest tenth of 1 degree.

Contact Information

USDA-APHIS-PPQ-S&T-TMT

13601 Old Cutler Road, Bldg. 63

Miami, FL 33158 USA

Phone: 305-278-4877

Fax: 305-278-4898

email: ppqmt@usda.gov

Certifying Facilities

Certification of Hot Water Immersion Facilities

Contents

Introduction	6-5-1
Submission and Approval of a New Facility Construction	6-5-2
Preliminary Performance Testing	6-5-2
New Procedures for Hot Water Facility Certification and Commercial Testing	6-5-3
Mango Temperatures Prior to Treatment	6-5-4
Permanent Probe Temperature	6-5-4
Procedures for Conducting the Annual APHIS Performance Test	6-5-4
Protocols for Foreign Treatment Facilities	6-5-7
Addresses for Technical Contact	6-5-7
USDA-APHIS-PPQ-S&T-TMT	6-5-7
Preclearance and Offshore Programs	6-5-7

Introduction

Quarantine treatment by immersion in hot water is used primarily for fruits that are hosts of tropical fruit flies. Exposing the fruit to a temperature of at least 115 °F (46.1 °C) for specific periods of time (depending upon the specific pest, type of fruit, and size of fruit) constitutes a quarantine treatment. The U.S. Department of Agriculture (USDA), Animal and Plant Health Inspection Service (APHIS) incorporates this principle of insect control into its regulations to facilitate the importation or interstate movement of certain fruits from areas where tropical fruit flies are the significant pests of concern.

Commercial facilities using hot water immersion treatment are subject to USDA-APHIS certification on an annual basis. More frequent tests may be required at the option of APHIS. APHIS certification is given solely in conjunction with quarantine treatment requirements.

NOTICE

The certifying official shall check with the manager of the facility to be sure that he is aware of the requirement for using potable water. Whenever water comes into contact with fresh produce, the water's quality dictates the potential for pathogen contamination. To reduce the risk of food-borne illnesses, the water used for washing, treatments, and cooling **must** be fortified with sodium hypochlorite (household bleach), and constantly maintained at a chlorine level **not** to exceed 200 ppm.

Submission and Approval of a New Facility Construction

The facility submits an application for approval of a new facility or for approval of plans to begin construction of a new facility.

Download and complete a fillable [Application for USDA Hot Water Treatment Facility Approval](#).

Preliminary Performance Testing

If the facility has **not** been previously certified by APHIS, the operators should conduct preliminary, informal performance tests on their own (together with an engineer, if needed), to assure themselves that their equipment is in good working order.

By trial and error, the manager of the facility should decide on a tentative temperature set point for their tanks. This should be done by immersing one or more full baskets of fruit into each tank, to be certain that the water temperature (nearest the fruit) reaches at least 115.0 °F (46.1 °C) within 5 minutes. A thermostatic set point for each tank is typically in the range of 115.8 °F to 116.9 °F (46.6 °C to 47.2 °C).

As an option, some hot water immersion systems use an initial higher set point for the first several minutes, then automatically drop to a lower set point for the remainder of the treatment. (If this programming option is used, the change to the second set point **must** be done automatically, **not** manually.)

Data from the preliminary tests need **not** be recorded on official forms. These data, however, **must** be presented to APHIS, as evidence that the facility is ready for the official performance test.

Once the facility has been officially certified, APHIS does **not** require the facility to present the preliminary performance test data in subsequent years, **except** when there have been major engineering changes to the equipment.

New Procedures for Hot Water Facility Certification and Commercial Testing

These guidelines have been issued to provide a more accurate reflection of the tank’s coldest temperatures. They are **not** intended to replace existing procedures, but to be used in conjunction with the current operational framework. These guidelines are only needed for facilities **not** capturing interior probe temperatures with actual sensors and are only in place until each facility begins capturing interior temperatures with actual sensors. Furthermore, these guidelines will be in effect until each facility develops a procedure for placing probes in the coldest locations of the tank. Facilities already using temporary probes as a routine part of commercial testing can disregard the procedures outlined below. All new equipment and procedures **must** be approved by the [USDA-APHIS-PPQ-S&T-TMT](#) before implementation.

Refer to [Table 6-5-1](#) for information regarding adjusted temperatures and set points:

Table 6-5-1 Hypothetical Certification Results: Treatment Tank with Multiple Set Points

Column No. 1	2	3	4	5	6
Tank Sensor (Lowest) (°F)	Portable Sensor (Lowest) (°F)	Adjusted Tank Sensor Temperature ¹ (°F)	Set Point (°F)	Treatment Interval (minutes)	Pulp Temperature (°F)
116.0	115.9	115.1	117.0	5	78
115.5	115.4	115.1	116.0	6 - 30	78
115.3	115.2	115.1	115.5	31 - 60	78
115.1	115.0	115.1	115.3	61 - 75	78
115.0	115.0	115.0	115.0	76 - 90	78

1 Adjusted Tank Sensor Temperature Equation:

Take the amount of temperature exceeding 115.0 from Portable Sensor (Lowest) in column 2, and subtract it from Tank Sensor (Lowest) in column 1 (116.0 - 0.9 = 115.1).

1. Average minimum pulp temperatures **must** be taken from a minimum of five fruit extracted from the coldest fruit before treatment. On certification day, this average pulp temperature becomes the minimum commercial treatment pulp temperature permitted. All fruit **must** be at or above 70 °F to be hot water treated.

2. The “adjusted tank sensor temperature” is determined by taking the amount of temperature exceeding 115.0 from Portable Sensor (Lowest) in column 2, and subtract it from Tank Sensor (Lowest) in column 1.
3. During certification, establish the set point with its lowest corresponding charted temperature. Document these values on the PPQ Form 482, Certificate of Approval, and an attachment in the format of [Table 6-5-1](#).
4. The [Table 6-5-1](#) attachment and PPQ Form 482 **must** be displayed in a prominent location at the facility.
5. During commercial treatments, the “Adjusted Tank Sensor Temperature” is used as the lowest treatment temperature. The commercial treatment fails if the tank temperature is below the “Adjusted Tank Sensor Temperature.”

Mango Temperatures Prior to Treatment

During certification, determine and record an average pulp temperature (prior to treatment). Calculate this averaged pulp temperature by averaging pulp temperatures from the five “coldest” mangoes before treatment (mangoes extracted from the coldest locations). This temperature becomes the minimum pretreatment pulp temperature allowable for commercial treatments.

Therefore, during subsequent commercial treatments, mangoes **must** be at or above this minimum temperature before beginning treatment. (Any fruit below 70 °F **cannot** be treated per manual requirements.)

Permanent Probe Temperature

During certification, record from the printout/chart each set point with its lowest corresponding charted (permanent probe) temperature. A treatment tank may have one set point or multiple set points. If the tank has multiple set points, these set points are for a fixed length of treatment time. Refer to [Table 6-5-1](#) for a detailed explanation. This “adjusted tank temperature sensor” (always above 115.0 °F) becomes the lowest temperature permitted for that set point, or the “standard” at that set point. Commercial temperatures (permanent probe temperatures from the chart/printout) **must** be equal to or greater than the set point standard for each length of time. Document each “adjusted tank sensor temperature” determined during certification, on the PPQ Form 482, Certificate of Approval and on the attachment to the Certificate.

Procedures for Conducting the Annual APHIS Performance Test

To approve the facility, the APHIS officer (or designated representative) shall take the following steps:

1. If the facility has not been previously certified, or if modifications have been made since the last performance test, compare the plans and drawings with the actual installation.

Clearly show dimensions, water circulation, temperature sensing and recording systems, and safeguarding precautions in the plans and specifications.

2. Conduct a performance test (at least annually), during an actual treatment as described below, to determine or verify a temperature “set point” for the system, and to determine the minimum duration of time required between the immersion of successive baskets of fruit within the same tank.
3. Inspect the heating, water circulation, and alarm systems, and check to see that all necessary safeguards (including screens, fans, locks, and air curtains) are secure and operational.
4. Calibrate the portable sensors, recording the results on APHIS Form 205, or a plain sheet of paper.
 - A. Using a factory-calibrated mercury, non-mercury, or digital thermometer as the standard, compare the reading of each portable sensor to the standard, and record any deviation.
 - B. To facilitate this process, a specially designed portable temperature calibrator may be used, which uses either hot air or a swirling hot water bath, set at approximately the temperature at which treatments will take place. A treatment tank can also be used for this purpose, provided that the water is kept in motion.
5. Examine the calibration of the tank’s permanent RTD sensors, and record the results on APHIS Form 206.
6. Tape the cords of three or four portable water temperature sensors to the skins of three or four selected fruits in each basket. Do **not** cover the end of the sensor with tape.
7. Insert a portable pulp temperature sensor approximately 1 centimeter into the flesh of one or more fruits in the tank.
 - A. Hold the sensor in place with tape.
 - B. It is **not** necessary to have a pulp temperature sensor in each basket.
8. Set the fruit at ambient temperature (70 °F or above) immediately prior to the performance test.

If the fruit is pre-warmed by artificial means, note this routine as a condition of approval that should be followed for each commercial treatment.

9. On the location diagram (APHIS Form 207), show the relative position of each portable sensor used in the test, and indicate whether it is a “water” or “pulp” sensor. Number each sensor.

10. While the fruit are immersed in water, use an electronic thermometer to monitor the temperatures of each portable sensor at various times throughout the test. Record this information on APHIS Form 208 for each tank.

As a second option, a portable automatic recording instrument can be used. It **must**, however, operate independently from the temperature recording system installed at the facility.

11. During the performance test, lower the baskets of fruit into the hot water immersion tank.
 - A. Closely monitor the water temperature sensors during the first 5 minutes of treatment.

APHIS requires that the temperatures of all water temperature sensors **must** reach at least 115 °F (46.1 °C) within 5 minutes; if **not**, in order to achieve the 5-minute temperature recovery requirement, repeat the test using other fruit using a slightly higher water temperature set point, and/or a slightly longer time interval between subsequent basket immersions.

- B. Run the test for the full duration (up to 90 minutes, depending upon fruit size).

During that time, all water temperature sensors **must** read at least 115 °F (46.1 °C) at the 5-minute point and beyond. In addition, the pulp temperature sensor (or sensors) **must** read at least 113 °F (45 °C) *by the end of the test*.

NOTICE

It should be noted that APHIS standards for passing the official performance test are higher than the standards accepted for commercial treatments. This is intentional. *During commercial treatments* of mangoes, the water in the tank is allowed up to 5 minutes to reach the minimum treatment temperature of 115 °F after the fruit have been submerged.

NOTICE

The mango hot water schedules also have a built-in tolerance for subnormal temperatures in the range of 113.7 °F to 114.9 °F for up to 10 minutes (in the case of 65 or 75-minute treatments), or 15 minutes (in the case of 90-minute treatments). This tolerance was designed to “save” an ongoing treatment during an emergency situation, such as an electrical power outage. However, *for the purposes of the official performance test*, all water temperature sensors are required to read at least 115.0 °F within the first 5 minutes, and to maintain temperatures at or above that threshold during the remainder of the treatment.

12. For issuance of a Certificate of Approval (PPQ Form 482), submit all supporting documents to the APHIS Regional Office (or to another APHIS office delegated by the Region).
13. APHIS will certify the facility only when all requirements are met, including two successful hot water immersion treatments in each tank using standard fruit loads.

For annual recertification, however, only one successful performance test is required per tank, unless the work plan requires additional tests. Submit a copy of PPQ Form 482, the corresponding attachment ([Table 6-5-1](#)), all forms used in the certification or recertification, and printouts from the temperature recorder to [USDA-APHIS-PPQ-S&T-TMT](#).

Protocols for Foreign Treatment Facilities

Contact the USDA-APHIS-PPQ [Preclearance and Offshore Programs](#) to obtain protocols for foreign treatment facilities.

Addresses for Technical Contact

USDA-APHIS-PPQ-S&T-TMT

13601 Old Cutler Road, Bldg. 63
Miami, FL 33158 USA
Phone: 305-278-4877
Fax: 305-278-4898
email: ppqmt@usda.gov

Preclearance and Offshore Programs

Director, Preclearance and Offshore Programs

USDA, APHIS, PPQ, POP
4700 River Road, 4th Floor
Riverdale, MD 20737
Phone: (301) 851-2281

Certifying Facilities

Certification of Niger seed Treatment Facilities

Contents

PPQ Regulation for the Entry of Niger Seeds into the United States	6-6-1
The Certification Process	6-6-1
Step 1—Submission and Approval of Engineering Construction Plan and Facility Requirements	6-6-2
Step 2—Request Certification for a Treatment Facility	6-6-2
Step 3—Conduct the Certification Test	6-6-2
Step 4—Certification of the Treatment Facility	6-6-4

PPQ Regulation for the Entry of Niger Seeds into the United States

In accordance with the guidance provided in this manual, heat treat Niger seeds (*Guizotia abyssinica*) from any foreign place for possible infestation with noxious weed seeds or prohibited pathogens at or before the time of arrival into the United States. Conduct the heat treatment in a foreign or domestic APHIS-certified treatment facility.

The Certification Process

Certification of Niger seed treatment facilities includes the following steps:

Step 1—Submission and Approval of Engineering Construction Plan and Facility Requirements on page 6-6-2

Step 2—Request Certification for a Treatment Facility on page 6-6-2

Step 3—Conduct the Certification Test on page 6-6-2

Step 4—Certification of the Treatment Facility on page 6-6-4

Step 1—Submission and Approval of Engineering Construction Plan and Facility Requirements

The facility submits an engineering construction plan and facility requirements to the appropriate State and country officials and to USDA-APHIS-PPQ-S&T-TMT for approval. The plans **must** include facility dimensions, capacity, heating unit specifications, and temperature/time recording system specifications.

Download a fillable [Application for USDA Niger Seed Heat Treatment Facility Approval](#) form.

Contact ppqmt@usda.gov with questions regarding the application.

USDA-APHIS-PPQ-S&T-TMT
13601 Old Cutler Road, Bldg. 63
Miami, FL 33158 USA
Phone: 305-278-4877
Fax: 305-278-4898
email: ppqmt@usda.gov

Facilities **must** comply with state, local, and country requirements. Design the equipment in a manner that will maintain the temperature at or above temperatures prescribed in the treatment schedule, T412-a. When the plans and requirements are approved, construct the treatment facility accordingly. Advanced written approval from S&T-TMT is required for any modification of the original plans.

Step 2—Request Certification for a Treatment Facility

The facility **must** submit a written request to S&T-TMT to request certification of a Niger seed treatment facility. The request should include the following:

- ◆ Assurance that the facility manager accepts responsibility for facility operations
- ◆ Assurance that the required equipment is on-site
- ◆ Data from at least two preliminary performance tests indicating the facility meets performance requirements for certification, including copies of completed recorder printouts
- ◆ Names, addresses, and phone numbers of the facility, facility manager or supervisor, and plant construction engineer

Step 3—Conduct the Certification Test

Initial **certification** testing will be conducted by S&T-TMT in conjunction with PPQ. For the purpose of **recertification**, S&T-TMT can delegate this responsibility to others.

Equipment and Materials

The treatment facility **must** supply the following equipment and materials in order to conduct a performance test for certification:

- ◆ Certified calibrated thermometer (temperature range to at least 270 °F (132.2 °C))
- ◆ Copy of plans and specifications showing dimensions and other details of heating and temperature recording systems
- ◆ Stopwatch and tape measure
- ◆ Temperature recording system to record temperature and treatment time

Facility Standards and Specifications

To qualify for certification/recertification, the treatment facility **must** conform to the following minimum standards and specifications:

- ◆ An action plan to address any pests that may be associated with the storage, treatment, and shipment of Niger seeds
- ◆ Audible alarm or highly visible light on burners or other equipment to indicate that the treatment equipment is **not** operating properly
- ◆ Automatic and continuous heating controls throughout the treatment process (manual adjustments are allowed, but **must not** negate the PPQ Form 480 guidelines)
- ◆ Gear systems used to control the Niger seed conveyor (if applicable) capable of being adjusted as needed to meet treatment requirements (the speed of the treatment conveyor **cannot** exceed the speed recorded on the PPQ Form 480)
- ◆ Permanent temperature sensors (minimum of two) placed at the beginning and end of treatment area in the seeds at commercial treatment depth
 - ❖ Accuracy of the temperature recording system and permanent sensors **must** be within plus or minus 0.5 °F (0.3 °C) of true temperature
- ◆ Portable temperature sensors (provided by facility or certifier) accurate to plus or minus 0.1 °C and calibrated at least once a year. The sensor **must** come with a calibration sheet containing correction factors **not** to exceed plus or minus 0.1 °C. Apply the calibration factors to the portable sensor readings.
- ◆ Proper sanitation measures to ensure there are **no** potential breeding grounds for pests on the premises and therefore, little risk of reinfestation or cross-contamination
- ◆ Recording system capable of recording temperature readings on a recorder printout in time intervals **not** exceeding 4 minutes between readings

- ◆ Secure valves and controls that affect heat flow to the treatment system to avoid manipulation during the treatment process by unauthorized personnel
- ◆ Seed processing equipment with the ability to divert for retreatment any untreated or treated seeds that do **not** meet treatment standards
- ◆ Speed indicator located on the conveyor for continuous treatment areas
- ◆ System to divert any untreated seeds away from the treated seeds (**DO NOT** mix treated and untreated seeds)
- ◆ Treated seeds stored in a location separate from the untreated seeds. The treated and untreated seeds **must** be handled in a manner to prevent cross-contamination

NOTICE

The appropriate permits and approval to import Niger seeds **must** be approved by the PPQ Permit Unit prior to shipping the commodity to the United States.

Step 4—Certification of the Treatment Facility

Use the following steps to obtain certification:

1. Record the speed of the belt before Niger seeds are in the treatment area. Place an object at beginning of belt. Use a stop watch or digital watch to record the time for the object to go from the beginning to end of treatment area. The speed **must** be 15 minutes or greater.
2. Attach approved portable temperature sensors (minimum of two) to the facility permanent sensors to duplicate the same angle and depth as the permanent sensors (the sensors are located at the beginning and end of the treatment area).
3. Niger seeds **must** be at a maximum depth during certification.
4. Treat the seed at 248 °F/120 °C for 4 or more hours. Seed that passes the certification is considered a positive treatment. The treated seed **must** pass TZ (tetrazolium) testing as stated in the work plan or compliance agreement.
5. Record the hertz or RPM of the treatment conveyor belt speed during certification. Verify that the speed indicator has been calibrated during the past year. Record the speed of the treatment conveyor belt on the PPQ Form 482.
6. Record the time that the treatment started and stopped on the portable sensor printout and facility recorder printout.
7. Check the system to verify that **no** cross-contamination has occurred.
8. Place the treated seed in new bags or store in silos designated for treated seed.

9. Verify that all portable sensors recorded 248 °F/121 °C or higher during the 4 or more hour treatment.
10. Ensure compliance with the latest work plan or compliance agreement.
11. Repeat treatment if certification fails.

If treatment standards are **not** met during performance testing, APHIS will **not** certify the facility. Provide a copy of the data sheet with explanation as to why the test was **not** acceptable to the facility operator for corrective action.

Certification of the Niger seed facility and equipment will be given after a successful treatment has been recorded (4 or more hours at 248 °F/120 °C). Upon certification, APHIS will issue a Certificate of Approval (PPQ Form 482). The conditions of approval **must** contain the following:

- ◆ **Must** operate under the latest work plan or compliance agreement
- ◆ Treat the seed for at least 15 minutes at a temperature of at least 248 °F/ 120 °C. Temperatures below 248 °F/120 °C will nullify the treatment.
- ◆ Treatment conveyor belt **must** operate at a speed **not** to exceed (x)Hertz or (x)RPM (x=speed of treatment conveyor belt)

Certifying Facilities

Certification of Forced Hot Air and Vapor Heat Treatment Facilities

Contents

Introduction	6-7-1
Plan and Process Approval	6-7-2
Preliminary Performance Testing	6-7-4
Official Certification Testing	6-7-4
Calibrating the Sensors	6-7-4
Thermal Mapping	6-7-5
Conducting a Test Treatment	6-7-7
Certification	6-7-7
Verification of Sensor Calibration	6-7-7
Documentation	6-7-8
Contact Information	6-7-8
USDA-APHIS-PPQ-S&T-TMT	6-7-8
Preclearance and Offshore Programs	6-7-8

Introduction

Forced hot air (FHA) and vapor heat (VH) treatment facilities **must** be certified by a qualified APHIS inspector. For brevity, “certification” and “recertification” will both be referred to as “certification” in this chapter.

For foreign treatment facilities, the physical location of the facility must be approved by the USDA APHIS PPQ [Preclearance and Offshore Programs](#) (POP). Domestic treatment facilities are approved by PPQ Field Operations or other entity defined in the workplan. After PPQ or POP approves the facility location and prior to the first facility certification, [USDA-APHIS-PPQ-S&T-TMT](#) must approve the plan and process description. Facilities must conduct tests prior to APHIS certification to ensure that the chamber meets treatment requirements. Certification tests must be carried out prior to treatment at the beginning of the shipping season once per year or whenever APHIS determines that a malfunction or alteration in the system warrants a certification test.

Certification will be granted on the basis of the ability of the chamber to meet treatment requirements, extent and condition of phytosanitary safeguards, sanitary (human health) conditions, and safety conditions. Facilities **must** be certified for each species (in some cases each variety or subspecies) of fruit,

each chamber load configuration (half full, quarter full, etc.) and, for some species, each size class of fruit treated. For example, mango and papaya are separate species and must be certified separately.

Facilities should be aware that certification may **not** be the only condition under which they may treat fruit for shipment to or within the United States. In addition to certification, there are other requirements, such as operational workplans, compliance agreements, and import permits that **must** be satisfied prior to treatment. Treatment facility managers outside the United States should contact POP. Managers of facilities in the United States or its territories should contact their local PPQ office for a complete list of requirements.

Plan and Process Approval

Prior to the start of facility construction, a detailed plan of the facility's physical characteristics and a written, step by step description of all the processes related to treatment **must** be approved by [USDA-APHIS-PPQ-S&T-TMT](#) (all plans and supporting materials must be submitted in Standard English). Plans and process descriptions for facilities within the United States and its territories **must** be submitted through the local PPQ office. Facilities outside the United States should consult POP for the appropriate plan submission procedure.

Download a fillable [Application for USDA Vapor Heat/Forced Hot Air Treatment Chamber Approval](#) form.

Contact ppqtmt@usda.gov with questions regarding the application.

At a minimum, plans **must** include the following information as diagrams and/or written descriptions:

- ◆ Areas designated for fruit arrival
- ◆ Areas designated for loading of treated fruit
- ◆ Areas for storage of untreated fruit
- ◆ Crates, lugs, bins, etc., that will be used to hold fruit during treatment, including total volume and projected fruit capacity
- ◆ Delineations of area(s) for storage of treated and untreated fruit
- ◆ Description of all processes related to treatment of fruit. These descriptions should reference diagrams with numbers where appropriate
- ◆ Hot water bath used for sensor calibration must have an accuracy of $\pm 0.3^{\circ}\text{C}$ (0.5°F)
- ◆ Physical location of facility

- ◆ Post-treatment cooling system
- ◆ Post-treatment packing
- ◆ Pre-treatment sorting and grading areas
- ◆ Reference thermometer must be approved by [USDA-APHIS-PPQ-S&T-TMT](#) or listed in [Equipment](#) on page 8-1-1. Calibrate reference thermometers once per year using an approved company listed in [Appendix E](#) of this manual.
- ◆ Systems designed to ensure phytosanitary security of the treated fruit
- ◆ Systems designed to ensure water which comes into contact with fruit is free of microbial or any other contaminants that may adversely affect human health
- ◆ Temperature recording system requirements:
 - ❖ Permanent and portable sensors and the temperature recorder must have an accuracy of ± 0.3 °C (0.5 °F) and must be approved by [USDA-APHIS-PPQ-S&T-TMT](#) or listed in [Appendix E](#).
 - ❖ Permanent sensors issued by the chamber manufacturer (not portable sensors) must be platinum 100-ohm resistive thermal detectors (RTD). The sensor unit must be within the distal 1 inch (2.54 cm) of the sensor. The sensor must have an outer sheath of 0.25 inches (6.4 mm) or less in diameter.
 - ❖ Recorder must be capable of printing the date, time, temperature (°F or °C), and alarms.
- ◆ Treatment chamber including heating system, crate arrangement within the chamber, and air flow

The number of permanent sensors is determined by the facility manufacturer. The APHIS official is responsible for facility approval and has the option to increase the number of permanent sensors as determined during chamber certification.

The process of reviewing the plans and process descriptions may take as long as sixty days and subsequent requests for additional information may further extend this time. Facilities should take this time constraint into account when developing a project timeline. Facilities will receive a letter granting plan approval or describing plan deficiencies. Plan approvals expire one year from the approval date if the facility has **not** been certified.

Preliminary Performance Testing

Following plan approval, the facility should be built according to the facility engineered plans. If deviations from the plans (including changes to the heating and temperature recording systems) are necessary, [USDA-APHIS-PPQ-S&T-TMT](#) **must** approve these changes. Submit changes in a manner similar to that described in [Plan and Process Approval](#).

After construction is completed, the facility **must** be tested to be sure it can meet all treatment requirements. These trials should test the ability of the treatment chambers to heat a full (maximum) load of fruit according to the treatment guidelines. Any problems or deficiencies found in the facility **must** be corrected and the preliminary tests **must** be re-run until all treatment requirements are met. After the facility representative is satisfied that the treatment system is running properly and can fully meet treatment requirements, they **must** submit results of the test to [Preclearance and Offshore Programs](#) or the local APHIS office for review.

Facilities will be provided with specific requirements as part of the plan approval letter. General requirements for test result submission are as follows:

- ◆ A diagram of chamber that shows location of each permanent sensor
- ◆ Amount, type, and size of fruit in load and in each crate
- ◆ Time and temperature data from the test run(s)

After POP reviews the results from the preliminary performance test, they will issue an approval or rejection letter. If approval is granted, the facility representative can then schedule an official certification test.

Official Certification Testing

The official certification test has two main components:

1. Calibrating the portable and permanent sensors
2. Thermal mapping (cold spot mapping)

These steps are discussed below in detail. Complete a certification test for each combination of fruit species, chamber load configuration, and, in some cases, fruit size class.

Calibrating the Sensors

If the facility is outside the United States, it is the responsibility of the exporter to provide sensors for the certification procedure. Temperature sensors can be either permanent or portable.

NOTICE

Use only sensors approved by [USDA-APHIS-PPQ-S&T-TMT](#). Refer to [Appendix E](#) for a list of approved sensors.

The number of portable and permanent sensors is determined by the APHIS certifying official. The APHIS official has the option to increase the number of sensors required.

Calibrate temperature sensors in a swirling hot water bath with a factory calibrated certified reference mercury, non-mercury, or digital thermometer with 0.1 °C (0.2 °F) graduations as a standard. The temperature of the swirling hot water bath must consistently read the treatment temperature on the certified reference thermometer. Place temperature sensors into the hot water bath and keep them there until the certified reference thermometer reads the treatment temperature for 10 consecutive minutes. After the temperature stabilizes, remove the sensors and read the data. Do not use any sensor that deviates by more than ± 0.3 °C (0.5 °F) from the treatment temperature. Record the greatest deviation for each sensor as the correction factor for that sensor. Any sensor that cannot be calibrated or repaired may not be used.

NOTICE

Refer to [Appendix E](#) for a list of approved digital thermometers.

Thermal Mapping

Thermal mapping determines the placement of sensors in the chamber. Because the sensors will be placed in the coldest areas of the chamber, this process is also referred to as “cold spot mapping” or “cold spot testing”. The sensors are placed throughout the chamber and the treatment is conducted. The sensors that took the longest time to record treatment temperature represent colder areas of the chamber. The thermal mapping procedure is as follows:

1. Based on basic thermodynamics and data from the preliminary performance test, develop hypotheses about which regions of the chamber are most likely to have cold spots. This will be based primarily on the direction of the air flow in the chamber. Chambers in which air flows in a single vertical direction will generally have cold regions in portions of the load that come into contact with the heated air last. For example, if the chamber delivers hot air from the bottom, the top of the load is likely to take longer to heat up because the fruit at the bottom absorbs heat first. In chambers where the air flow changes direction or the air delivery is horizontal, it may be more difficult to form these types of hypotheses.
2. The fruits selected for the test must be similar in size, ripeness, and variety. Sort the fruit and select a subset totaling the number of sensors plus 20 percent. The difference between the heaviest and lightest fruit must not be more than 5 percent or higher (at the discretion of the certifying official) of the heaviest fruit’s weight.

3. Place one sensor in each of the largest fruit collected. Place the most sensitive portion of the sensor in the area of the fruit pulp most resistant to temperature change, usually the center of the fruit or close to the pit.
4. Based on the hypotheses formed in #1 above, place the majority of the sensors in the areas thought to be cold regions. In order to verify the hypothesis, place a portion of the sensors in the areas thought to be warmer. If no hypotheses were formed in #1 above, sensors **must** be placed in a systematic pattern that can provide a complete thermal map of the entire load.

NOTICE

Each chamber may require a different number of sensors depending on factors such as the chamber size, chamber dimensions, air flow patterns, and size and species of the fruit. Typically, a chamber approximately the size of a standard 40 ft. shipping container will require about 60 sensors.

5. Create a map of the chamber that shows the relative horizontal and vertical location of each sensor.
6. Conduct the treatment.
7. Remove the sensors and read their data.
8. Determine the amount of time each sensor took to reach treatment temperature. The sensors which required the longest time to reach treatment temperature indicate cold spots.

NOTICE

All sensors **must** reach treatment temperature.

9. Create a map of the cold spots based on the map created in step #5 and the analysis completed in step #8.
10. Repeat this process for each load/volume configuration to ensure that correct and consistent cold spots are found. Results from the two consecutive tests must be similar.
11. Based on the conclusion of two consecutive tests, create a map showing the location of each permanent temperature sensor for each load/volume configuration.

NOTICE

If thermal mapping shows that difference in the time required to reach treatment temperature between any two sensors is greater than 2 hours, the chamber will **not** be certified.

A facility cannot perform a commercial treatment between recertification tests.

Conducting a Test Treatment

Conduct a test treatment in order to verify that the chamber is capable of meeting treatment requirements and for any of the following situations:

- ◆ A new facility is approved
- ◆ The heating system is changed
- ◆ The recording system is changed

Test treatments are only required for the maximum load/volume configuration that the facility will be certified for and may be done in conjunction with the thermal mapping. The procedure for conducting a test treatment is as follows:

1. Place sensors in areas of the load that are thought to be cold spots (based on thermal mapping data).
2. Conduct the treatment.
3. During treatment, inspect the outside of the chamber to be sure it is free of leaks, is operating smoothly, and generally is in good working order.
4. After treatment is completed, review the temperature logs. All sensors **must** have reached the treatment temperature.
5. After a successful test treatment, continue to [Certification](#) section.

Certification

Upon successful completion of the facility certification test (as indicated by completion of the APHIS Form 482), the commercial treatments can begin.

A certification test is required once a year, usually at the beginning of the shipping season, if a new heating or recording system is approved, or whenever the system has a malfunction, breakdown, or other failure (excluding malfunction of temperature sensors.)

Verification of Sensor Calibration

Verify the integrity of the temperature sensors daily using the process described in [Calibrating the Sensors](#) on page 6-7-4.

Calibration can also occur whenever any part of the permanent temperature recording system fails or is replaced, or at the discretion of the APHIS inspector.

Documentation

All tests performed during certification **must** be documented by the APHIS official. Send a copy of the signed APHIS Form 482, copies of all thermal maps, description of load size limitations, description of any other special limitations placed on the treatment, and any other pertinent addenda or appendices, to [USDA-APHIS-PPQ-S&T-TMT](#) for final approval.

Contact Information

USDA-APHIS-PPQ-S&T-TMT

13601 Old Cutler Road, Bldg. 63
Miami, FL 33158 USA
Phone: 305-278-4877
Fax: 305-278-4898
email: ppqmt@usda.gov

Preclearance and Offshore Programs

Director, Preclearance and Offshore Programs

USDA, APHIS, PPQ, POP
4700 River Road, 4th Floor
Riverdale, MD 20737
Phone: (301) 851-2281

Certifying Facilities

Certifying Irradiation Treatment Facilities

Contents

Introduction	6-8-1
Pre-Certification Requirements	6-8-2
Plan Approval Application	6-8-2
Certification Requirements	6-8-3
Certification by the National Nuclear Regulatory Authority	6-8-4
Approved Source	6-8-4
Dosimetry System	6-8-5
Standard Operating Procedures	6-8-7
Staff Training	6-8-9
Infrastructure	6-8-9
Safeguarding	6-8-10
Process Configurations	6-8-10
Facility Compliance Agreement	6-8-10
PPQ Form 482 Certificate of Approval	6-8-11
Recertification	6-8-11
Adding Cobalt 60	6-8-12
Audits	6-8-13
Contacts	6-8-13

Introduction

Certification of irradiation facilities ensures that each facility's equipment and personnel are able to safely, accurately, and consistently administer the required minimum absorbed dose (MAD) to all components of the commodity. This chapter describes the process and requirements for certification of facilities that irradiate agricultural products for import into or movement within the United States.

Facilities, exporters, and others interested in the administrative and operational processes for establishing irradiation programs, applying for permits, and

signing compliance agreements can find more information on the [USDA APHIS PPQ irradiation treatment website](#).

PPQ officials reviewing plan approval applications or conducting certification and recertification activities must follow the guidelines in this chapter. If a PPQ official finds that a deviation from these guidelines is necessary, or if a facility requests a deviation, the PPQ official will direct the facility to develop a detailed proposal outlining the need for the deviation. The proposal will be forwarded to [USDA-APHIS-PPQ-S&T-TMT](#) for review. Following review, S&T-TMT will make a recommendation to the Treatment Cross Functional Working Group (TCFWG) for a decision. The TCFWG will make the final decision on the proposal and the operational unit will communicate the decision to the facility. The process of reviewing a proposal may take as long as 60 days.

Pre-Certification Requirements

Prior to starting any certification work, facilities located in the United States should contact [USDA-APHIS PPQ Field Operations](#) to discuss the certification process and requirements. This discussion will help facilitate the certification process and processes associated with the establishment of an operational program.

Facilities located in countries other than the United States should contact the National Plant Protection Organization (NPPO) in their country to request information and certification to PPQ via official channels. Foreign facilities should not contact PPQ without first consulting with their NPPO.

Plan Approval Application

The first step in the certification process is to download and complete the [Application for Irradiation Facility Approval](#) form.

The application collects information about the facility, including radiation source type and strength, standard operating procedures, facility diagram, and other information that helps PPQ understand how the facility operates.

Facilities located in the United States should send the completed application to [USDA-APHIS PPQ Field Operations](#). Facilities located in countries **other than** the United States must submit their applications through their NPPO, which will then forward the application to [USDA-APHIS International Services \(IS\)](#). The application will then be forwarded to PPQ Phytosanitary

Issues Management (PIM), and Preclearance and Offshore Programs (POP) (refer to [Figure 6-8-1](#)).

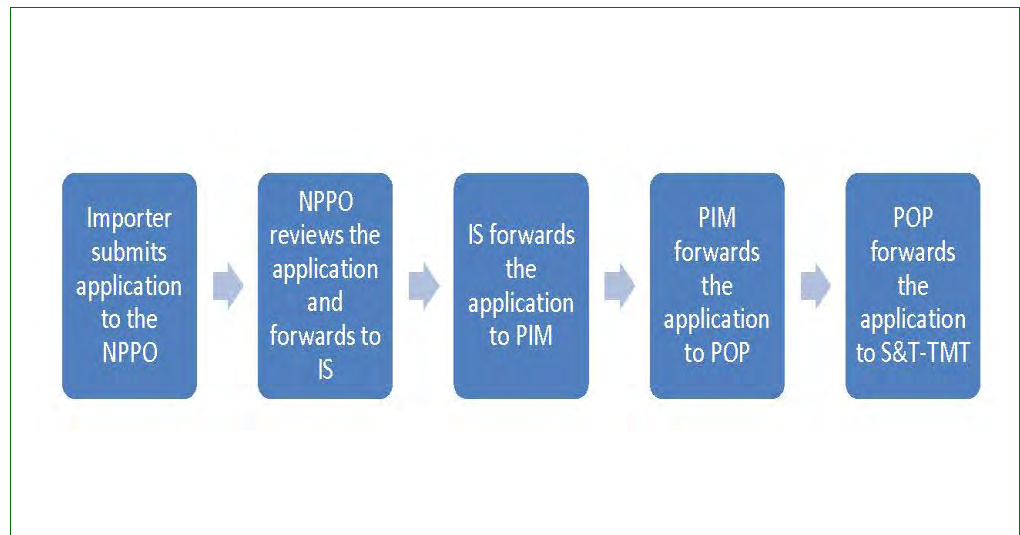

Figure 6-8-1 Flow Diagram for Plan Approval Application for Irradiation Facilities in Countries Other Than the United States

The S&T-TMT review may take as long as 60 days. Facilities are encouraged to submit their applications well in advance of the desired certification date. Following review, S&T-TMT will communicate the results of the review through the appropriate operational unit, including Field Operations and POP. The results may be approval of the application or a request for additional information or clarification.

Once the application is approved by S&T-TMT, an onsite certification inspection can be scheduled. The appropriate operational unit will work with the facility to schedule a date for the certification inspection. S&T-TMT will provide a copy of the application, along with any notes or relevant information to the certifying official. This information will help prepare the certifying official.

Certification Requirements

Certification will include a review of the following:

- ◆ Dosimetry system
- ◆ Phytosanitary safeguards
- ◆ Standard operating procedures and documentation
- ◆ The facility structure
- ◆ Treatment and certification records

- ◆ Other processes, procedures, equipment or infrastructure that may affect treatment or safeguarding

Prior to conducting the certification activities, the certifying official must:

- ◆ Carefully review the [Application for Irradiation Facility Approval](#) to gain a full understanding of the processes, procedures, and systems used at the facility.
- ◆ Develop an agenda with the facility to ensure that the official is able to observe or examine all the necessary minimum processes, procedures, and/or systems required for certification.
- ◆ Familiarize themselves with the American Society for Testing and Materials (ASTM) standards that apply to the facility. *See [ASTM Standards](#) on page 6-8-13.*
- ◆ Review the standards for selection and calibration of dosimetry systems, estimating uncertainty, processing standards, and the standards specific to the routine dosimetry system.

Certification by the National Nuclear Regulatory Authority

For facilities using radioactive isotopes, certification by the National Nuclear Regulatory Authority (NNRA) of the country in which the facility is located is one of the most important things to verify during certification. This certification is important because it indicates that the facility meets national and international standards for safety, security, and monitoring. In the United States, some States have agreements with the U.S. Nuclear Regulatory Commission (NRC) that allow agencies in those states to issue the certifications. Certifying officials who certify facilities must verify that the certificate issued by the NNRA is current.

Approved Source

Three sources of radiation are approved by APHIS for phytosanitary treatments:

- ◆ Electrons generated from machine sources up to 10 MeV (eBeam)
- ◆ Radioactive isotopes (gamma rays from cobalt-60)
- ◆ X-rays (up to 7.5 MeV)

The certifying official must verify that the facility is using one of these sources by examining the facility's records and/or verifying that standard operating procedures (SOPs) are in place that ensure delivery of radiation at the appropriate energy level.

Dosimetry System

The routine dosimetry system is critical for accurate and precise measurement of dose. Measurements of dose may not provide assurance that the proper treatment was delivered if the dosimetry system is not properly configured, calibrated, operated by qualified individuals, and precise in the appropriate dose range. The certifying official must ensure that the dosimetry system, and the management and operation of that system, meet the requirements in this chapter.

The facility's routine dosimetry system must follow guidance in ISO/ASTM standard 51261 "*Standard Guide for Selection and Calibration of Dosimetry Systems for Radiation Processing*" and other ASTM standards that specifically address the routine dosimetry system in use. Facility staff should be well-versed in the applicable standards and have copies on hand for reference. See [ASTM Standards](#) on page 6-8-13.

Absorbed Dose Range

The facility's routine dosimetry system must be accurate and precise in the dose range required for PPQ treatments. When selecting a routine dosimetry system, facilities must follow guidance from dosimetry system-specific ASTM standards to determine which systems meet PPQ's dose range requirements. For example, ISO/ASTM 51310 "*Standard Practice for Use of a Radiochromic Optical Waveguide Dosimetry System*" provides guidance that "The absorbed dose range is from 1 to 10,000 Gy for photons.". Because this range includes the PPQ irradiation treatments, this is an acceptable dosimetry system. See [ASTM Standards](#) on page 6-8-13

Calibration

Calibration of the routine dosimetry system is critical to measuring absorbed dose during routine treatments. Descriptions of calibration techniques and procedures can be found in ISO/ASTM standard 51261 "*Standard Guide for Selection and Calibration of Dosimetry Systems for Radiation Processing*". Facilities must follow guidance in the procedures and techniques described in these standards or in equivalent standards recognized by the APHIS Administrator. The certifying official should review calibration procedures and documentation with the facility staff to verify that the routine dosimetry system has been calibrated using guidance from and adherence to the applicable ASTM standards.

All routine dosimetry system calibration must be traceable to the U.S National Institute of Standards and Technology (NIST). Facilities must keep records that show traceability of calibration to NIST, including certificates of calibration from NIST.

Uncertainty Estimates

Facilities must develop estimates of measurement uncertainty associated with routine dosimetry systems. Uncertainty parameters describe variability in measurement estimates and measurement correction factors can be calculated from these estimates. Each facility must follow guidance in ISO/ASTM 51707 “*Standard Guide for Estimating Uncertainties in Dosimetry for Radiation Processing*”. Certifying officials should review uncertainty estimates and related correction values with facility staff and verify that procedures used to develop the estimates and correction values follow guidance in the relevant ASTM standards. See [ASTM Standards](#) on page 6-8-13.

Influence Factors

Dosimetry systems can be influenced by factors that introduce error into estimates of absorbed dose. The influencing factors may include heat, humidity, or light, and the magnitude of the effects of these factors vary between dosimetry systems. Influencing factors are described in ASTM standards for specific dosimetry systems, such as ISO/ASTM 51310 “*Standard Practice for Use of a Radiochromic Optical Waveguide Dosimetry System*”. Facilities must follow guidance in these standards when developing procedures to mitigate the effect of influence factors on dose estimates. Certifying officials should verify that facilities are aware of the influencing factors with the potential to affect their dosimetry systems and have taken steps to minimize these effects and/or account for the effect in measurement estimates.

Dosimetry Procedures

The facility dosimetry staff should demonstrate important dosimetry procedures to the certifying official. These procedures should include, but are not limited to:

- ◆ Archiving dosimeters
- ◆ Calculating estimates of absorbed dose and applying correction factors
- ◆ Preparing and reading dosimeters
- ◆ Storage and handling of dosimeters
- ◆ Tracking dosimeters
- ◆ Verification of calibration

The certifying official should verify that these procedures match those in the facility’s SOPs and follow the guidance in the applicable ASTM standards.

Standard Operating Procedures

Irradiation facilities must have SOPs that fully describe processes related to treatment of APHIS regulated articles. Additionally, these SOPs must include documentation of important data and events. The SOPs and documentation are critical for ensuring that well designed processes are executed and that records show that the processes were followed. The certifying official should carefully examine the SOPs and documentation to ensure that they are being implemented. Additionally, the facility should demonstrate to the certifying official the procedures related to:

- ◆ Analyzing routine dosimeters and reporting results
- ◆ Certification of treatment, releasing articles for shipping, loading articles into conveyances
- ◆ Creating configurations and placing routine dosimeters on configurations prior to treatment
- ◆ Emergency shutdown and natural disaster preparedness
- ◆ Inspection of conveyances
- ◆ Managing pest detections and disposal or destruction of infested and/or untreated articles (information on disposal and destruction for facilities in the United States can be found in the *Manual for Agricultural Clearance*)
- ◆ Maps of agricultural production areas within a four-square mile area (for U.S. facilities in AL, AZ, CA, FL, GA, KY, LA, MS, NV, NC, SC, TN, TX, VA)
- ◆ Pest trapping, monitoring, and control
- ◆ Post-treatment handling of articles and collection of routine dosimeters
- ◆ Receiving articles and preparing them for treatment
- ◆ Safeguarding or protecting articles from potential pest infestation pre- and post-treatment
- ◆ Verifying article, package condition, and package weights and labeling
- ◆ Other procedures the PPQ official deems appropriate

Change Control

All facilities must maintain a change control system for managing changes to SOPs and documentation. The change control system should be designed to capture information about changes to the SOPs and documentation. This system should collect information about:

- ◆ Details about the change to the SOP or document
- ◆ The person, or people, who authorized the change to the SOP or document
- ◆ The reason the change was made to the SOP or document

- ◆ When the SOP or document was changed

Additionally, the change control system **must** include processes for ensuring that old SOPs and documents are retired or no longer available for use.

The certifying official **must** review this system with the facility staff to ensure that the change control system is properly implemented.

PPQ Specific Data Collection and Storage Requirements

PPQ has program specific data storage requirements that all facilities must meet. All facilities **must** store the following general records:

- ◆ Configuration and dose mapping records for each commodity that is treated
- ◆ Dosimetry system calibration records
- ◆ Ionizing energy source
- ◆ Operational Workplan(s) for the commodities treated at the facility
- ◆ PPQ Form 482, Certificate of Approval
- ◆ PPQ Treatment Schedule(s)
- ◆ PPQ Compliance Agreement
- ◆ Record(s) of training and credentials of facility employees
- ◆ Written agreements with participating packing houses (for facilities located outside the United States only)

Additionally, each facility **must** have a system for collecting and storing information related to each treatment. The following information **must** be stored for at least one year:

- ◆ Date of irradiation treatment
- ◆ Dosimetry data for each PPQ treatment
- ◆ Evidence of compliance with the prescribed treatment
- ◆ Irradiation processor's certificate of treatment
- ◆ Lot number (except for interstate movement)
- ◆ Name and quantity of article treated
- ◆ Packinghouse code (PHC) assigned by the NPPO of the exporting country to the packinghouse where the articles were packed (except for interstate movement)
- ◆ Prescribed treatment

- ◆ Production unit code (PUC) assigned by the NPPO of the exporting country to the area where the articles were produced (except for interstate movement)
- ◆ Treatment identification number (TIN)

Staff Training

All facility personnel with treatment-related responsibilities **must** have received training in applicable standards, PPQ treatment requirements, applicable operational workplans, and facility SOPs and documentation systems. Training should be documented and available for review by the inspecting official. Additionally, the inspecting official should evaluate the knowledge of facility staff by requesting that they demonstrate operations, as described in the [Standard Operating Procedures](#) section.

Infrastructure

Facilities may be designed and built to meet the needs of the operator and must meet international safety and security requirements. However, there are several PPQ specific requirements that **must** be met:

- ◆ Inspection area
 - ❖ The facility must have an area for inspection of articles and packages. Facilities located in the United States must have scales for verification of box and load weights. Facilities located outside the United States must be equipped with cutting boards, knives, magnifying glass, and scales for use by PPQ officials.
- ◆ Internet connection
 - ❖ The facility must have a high speed Internet connection that allows uninterrupted connection to the Irradiation Reporting and Accountability Database (IRADS).
- ◆ Physical barrier between treated and untreated articles
 - ❖ The facility must have a sturdy physical barrier that separates the areas where untreated and treated articles are present. The barrier may have a door for personnel or equipment to pass through. However, this door must remain closed when not in use.
- ◆ PPQ workspace
 - ❖ The facility must set aside an area for the PPQ official to work. This area should include a desk, chair, and access to high speed Internet.

The certifying official must verify that the infrastructure is in place and functional.

Safeguarding

Facilities **must** have phytosanitary safeguards in place to prevent pest infestation and movement of pests. Safeguarding requirements may vary depending on the location of the facility, the proximity of host crops, and the risk of pests associated with commodities treated at the facility. PPQ operational staff will develop safeguarding requirements for each facility based on the unique circumstances at each facility. However, safeguarding requirements frequently include measures such as:

- ◆ Air curtains
- ◆ Cold storage areas
- ◆ Double doors
- ◆ Screens on windows
- ◆ Sealed cracks or holes that insects might move through

Process Configurations

During the certification activity, each facility must test at least one process configuration. This test must be observed by the certifying official. This initial test helps ensure that the facility fully understands the PPQ process configuration, testing, and approval process, and can successfully conduct the testing. Additionally, the configuration test also serves to provide evidence that the facility can deliver a dose in the required range.

Contact [USDA-APHIS PPQ Field Operations](#) for more information on process configurations.

Facility Compliance Agreement

Each PPQ certified facility must have a compliance agreement (or equivalent) in place prior to certification. There are three standard compliance agreements, one each for:

- ◆ Facilities in the United States that treat articles imported from foreign countries
- ◆ Facilities in the United States that treat articles for interstate movement
- ◆ Facilities located outside the United States

These standard compliance agreements may be modified to include information specific to a facility or specific risks associated with the articles

that may be treated at the facility. Operational managers must review and approve modifications to the compliance agreements.

NOTICE

Compliance agreements will be reviewed annually by PPQ. The compliance agreement between PPQ and the irradiation facility is different from the compliance agreement between PPQ and importers. Refer to the [USDA APHIS PPQ Irradiation website](#) for more information on compliance agreements with importers.

PPQ Form 482 Certificate of Approval

When the certification activity is complete and the certifying official is satisfied that all requirements are met, the certifying official will issue a PPQ Form 482 Certificate of Approval. This form is the official certificate, and once the facility receives the Form 482 it may begin routine treatments, provided it has a current compliance agreement.

The certifying official should send electronic copies of the PPQ 482 to [USDA-APHIS-PPQ-S&T-TMT](#) and [USDA-APHIS PPQ Field Operations](#).

Recertification

Periodic certification of irradiation facilities is **not** required. However, facilities will be recertified under the following conditions:

- ◆ Changes to operations or infrastructure
 - ❖ Examples include but are not limited to altering the manner in which articles are exposed to the source or changing dosimetry systems
- ◆ Change to the source
 - ❖ Any irradiation source replenishment requires recertification. Further examples include, but are not limited to, changes to the equipment that delivers radiation, changing the cobalt configuration, or increasing or reducing source strength by adding or removing source material
- ◆ Management change
 - ❖ Change in management that results in new processes or procedures that change operations at the facility
- ◆ Problems with the facility
 - ❖ Examples include but are not limited to the inability to accurately measure dose or the failure or inability to follow SOPs or document processes

Facilities that are unsure if they require recertification should contact the appropriate operational unit.

Certified facilities must provide at least 90 days' notice prior to making changes to the radiation source or changes to operations or infrastructure. Notice of change in management or problems at a certified facility must be made within 14 days. All information related to changes in source, occurrence of problems, change in management, and/or changes to operations or infrastructure should be detailed and specific, and clearly describe the situation and the steps the facility is proposing to address any issues.

Facilities located in the United States should send recertification notifications to [USDA-APHIS PPQ Field Operations](#). Facilities located in other countries must submit their recertification notifications through their NPPO, which will in turn forward it to APHIS IS. The information will then be forwarded to PIM and POP.

In some cases, recertification will not require an onsite recertification inspection. Operational staff will review requests for recertification and decide whether an onsite or remote recertification is appropriate.

Adding Cobalt 60

One of the most common reasons for recertification is the addition of new cobalt 60 to increase total source strength. When cobalt 60 is added to an irradiator, the facility must characterize the dose distribution of the new source configuration. Facilities must follow the source characterization as described in ISO/ASTM standard 51702 "*Standard Practice for Dosimetry in a Gamma Irradiation Facility for Radiation Processing*". Generally, the goal of this characterization will be to describe the dose distribution of the new source and its affects, if any, on the dose delivered to articles during treatment.

Facilities should send the written results of the source characterization to PPQ operational units when the characterization is complete. These results should include the following:

- ◆ A detailed and specific narrative that describes the characterization process that was followed
- ◆ Analysis of the characterization data along with a detailed and specific explanation of the analysis
- ◆ Proposed course of action, including proposed actions for changing existing process configurations
- ◆ The data from the characterization study

PPQ will review the characterization information and determine if the facility's proposed course of action is appropriate and if the facility can be recertified.

Audits

Onsite audits of facilities may be performed from time to time by PPQ. These audits may cover a wide range of processes, procedures, and documentation at a facility. Facilities should be prepared to demonstrate operational procedures and have records available for review by the PPQ auditor. Audits will be conducted when operational units determine that they are necessary.

Electronic audits may also be performed by PPQ. These electronic audits will generally utilize data from the IRADS system to look for anomalies or indications that treatments are not being applied correctly.

Contacts

ASTM Standards

Copies of the ISO/ASTM methods may be examined at the USDA APHIS PPQ Headquarters Library located at 4700 River Road, Riverdale, MD, 20737. Copies of ISO/ASTM Standard Methods may also be obtained from the American Society for Testing and Materials, 100 Barr Harbor Dr., West Conshohocken, PA 19428-2959.

USDA-APHIS International Services (IS)

Refer to the USDA-APHIS International Services [website](#) for a list of International Service offices.

USDA-APHIS-PPQ-S&T-TMT

email: ppqmt@usda.gov

USDA-APHIS PPQ Field Operations

email: PPQ.Ops.Treatments@usda.gov

Certifying Facilities

Certifying Facilities for the Heat Treatment of Firewood

Contents

Introduction	6-9-1
Plan and Process Approval	6-9-2
Official Certification Testing	6-9-3
Calibrating the Temperature Sensors	6-9-3
Thermal Mapping	6-9-4
Conducting a Test Treatment	6-9-5
Frequency of Certification and Temperature Sensor Calibration	6-9-5
Documentation	6-9-6
Contact Information	6-9-6

Introduction

Agrilus planipennis Fairmaire (Coleoptera: Buprestidae), commonly known as the emerald ash borer (EAB), is a wood-boring insect that infests firewood. This destructive beetle attacks all North American species of ash trees and has been detected in many states across the United States and Canada. For more information on the pest and a map of current quarantine areas, visit the [USDA Emerald Ash Borer website](#).

The *Lymantria dispar* L. feeds on over 500 species of trees and shrubs. Potentially, all temperate hardwood growing areas of North America are at risk from attack by the moth. Despite all attempts to prevent its movement, the moth has been quite successful in increasing its range along the leading edge of the quarantine area. For more information on the pest and a map of current quarantine areas, visit the [USDA Regulated Lymantria Moth website](#).

Heat treatment is an approved treatment for these two common wood pests. The treatment **must** occur in a certified heat treatment facility. The purpose of this chapter is to provide guidelines for the certification of a heat treatment facility.

Heat treatment facilities **must** be certified by a qualified PPQ official. For brevity, “certification” and “recertification” will both be referred to as “certification” in this chapter.

Certification tests **must** be carried out prior to treatment to allow movement of wood from the current quarantine areas, or whenever a malfunction or alteration in the system warrants a certification test.

Certification will be granted on the basis of the ability of the chamber to meet treatment requirements, extent and condition of phytosanitary safeguards, and safety conditions.

Facilities should be aware that certification may **not** be the only condition under which firewood for shipment can be moved from quarantine areas. In addition to certification, there are other requirements that **must** be satisfied prior to treatment:

- ◆ A compliance agreement
- ◆ An operational work plan
- ◆ Appropriate federal, state, or local permits

Treatment facility managers should contact their local PPQ office and/or local state departments of agriculture for state-specific requirements.

Plan and Process Approval

Prior to the start of the certification process for a new or existing facility, a detailed plan of the facility's physical characteristics and a written, step by step description of all the processes related to treatment **must** be approved by USDA-APHIS. Plans and process descriptions **must** be submitted through the local PPQ office.

At a minimum, plans **must** include a description of all processes related to the heat treatment of firewood. These descriptions should reference diagrams with numbers where appropriate. Submit the following information as diagrams and/or written descriptions:

- ◆ Areas designated for:
 - ❖ Arrival and storage of untreated firewood
 - ❖ Loading of untreated and treated firewood
 - ❖ Storage of untreated and treated firewood
- ◆ Crates, bins, racks, etc., used to hold firewood during treatment, including total volume and projected capacity
- ◆ Physical location of facility
- ◆ Post-treatment cooling system
- ◆ Post-treatment packaging

- ◆ Pre-treatment sorting and grading areas
- ◆ Systems to ensure phytosanitary security of the treated wood
- ◆ Treatment chamber including heating system, arrangement within the chamber, and air flow

The process of reviewing the plans and process descriptions may take as long as 60 days, and subsequent requests for additional information may further extend this time. Facilities should take this time constraint into account when developing a project timeline. Facilities will receive a letter granting plan approval or describing plan deficiencies. Plan approvals expire 1 year from the approval date if the facility has **not** been certified.

Official Certification Testing

Following plan approval, facilities seeking certification **must** be tested to ensure they can meet all treatment requirements. If deviations from the plans are necessary, PPQ **must** approve these changes prior to testing. Changes should be submitted in a manner similar to that described in [Plan and Process Approval](#).

The official certification test has three main components:

- ◆ [Calibrating the Temperature Sensors](#)
- ◆ [Thermal Mapping](#) (cold spot mapping)
- ◆ [Conducting a Test Treatment](#)

These steps are discussed below in detail. A certification test **must** be completed for each chamber load configuration.

Calibrating the Temperature Sensors

NOTICE

Only temperature sensors approved by USDA-APHIS may be used. Contact the PPQ personnel listed in [Contact Information](#).

Calibrate all temperature sensors prior to facility certification tests and a minimum of once annually thereafter. In addition, if a permanent temperature recording system is used, the system **must** be recalibrated when any part or portion of the system is repaired or replaced. Calibrations **must** be performed by the temperature sensor manufacturer or by manufacturer trained technicians. All temperature sensors **must** read within +/- 0.5 °C (0.9 °F) of the treatment temperature.

Thermal Mapping

Thermal mapping determines the placement of permanent temperature sensors in the chamber. Because the permanent temperature sensors will be placed in the coldest areas of the chamber, this process is also referred to as cold spot mapping, or cold spot testing. The process of thermal mapping is relatively simple: portable temperature sensors are placed throughout the chamber and the treatment is conducted. The sensors that took the longest time to record treatment temperatures represent colder areas of the chamber.

NOTICE

Each facility may require a different number of portable sensors depending on factors such as the chamber size, chamber dimensions, and air flow patterns. A facility that is less than or equal to 10,000 ft³ will require about 20 sensors for a thorough temperature mapping. Contact the PPQ personnel listed at the end of this chapter for help in determining the number of sensors required for a facility larger than 10,000 ft³.

The thermal mapping procedure is as follows:

1. Drill holes a minimum of 4 inches deep into the ends of the largest pieces of wood. The diameter of the hole should be equivalent to the outer diameter of the sensor.
2. Place sensors in the wood and in various locations throughout the entire chamber.
3. Create a diagram of the chamber that shows the relative horizontal and vertical location of each temperature sensor.
4. Conduct the treatment.
5. Remove the temperature sensors and analyze the temperature data.
6. Determine the amount of time each temperature sensor took to reach the treatment temperature. The temperature sensors that required the longest time to reach treatment temperatures indicate cold spots.
7. Create a map of the cold spots based on the map created in step #3.
8. Repeat this process for each load and volume configuration to ensure that correct and consistent cold spots are found.
9. Based on the thermal maps created in step #7, create a map to indicate where temperature sensors should be placed for each load and volume configuration during daily operational treatments.

Conducting a Test Treatment

A test treatment **must** be performed to verify that the chamber is capable of meeting treatment requirements. Test treatments are only required for the maximum load/volume configuration that the facility will be certified for, and may be done in conjunction with the thermal mapping described above. The procedure for conducting a test treatment is as follows:

1. Place permanent temperature sensors in areas of the load that are thought to be cold spots (based on thermal mapping data).
2. Conduct the treatment.
3. After treatment is completed, review the temperature data from the temperature sensors. All temperature sensors **must** have reached the treatment temperature.

These trials should test the ability of the treatment chambers to heat a full (maximum) load of wood according to the treatment guidelines. Any problems or deficiencies found in the facility or with the treatment **must** be corrected and the tests run again until all treatment requirements are met. After the facility representative is satisfied the treatment system is running properly and can fully meet treatment requirements, test results **must** be submitted to USDA-APHIS for review.

The process of reviewing results from preliminary performance tests may take as long as 30 days. After USDA-APHIS-PPQ reviews the results from the preliminary performance test, a letter will be issued either approving or rejecting the results. Once the facility is approved, treatment and shipment may begin.

Frequency of Certification and Temperature Sensor Calibration

A certification test is required once a year, and/or whenever the system has a malfunction, breakdown, or other failure that requires modifications that alter the manner in which the system functions. This excludes the replacement of a faulty temperature sensor.

All temperature sensors **must** be calibrated at the discretion of the PPQ official, annually, or whenever any part of the temperature recording system fails or is replaced. Use the process described in the [Calibrating the Temperature Sensors](#) section of this chapter.

Documentation

All tests performed during certification **must** be documented by the PPQ official. A copy of the signed APHIS Form 482, copies of all thermal maps, description of load size limitations, description of any other special limitations placed on the treatment, and any other pertinent addenda or appendices **must** be sent to USDA-APHIS-PPQ for final approval.

Contact Information

USDA-APHIS-PPQ
Russ Bulluck, National Operations Manager
Raleigh, NC 27606-5210
Phone: (919) 855-7182
Russ.Bulluck@usda.gov

USDA-APHIS-PPQ
Herbert Bolton, National Program Coordinator
4700 River Road, Unit 137
Riverdale, MD 20737
Phone: (301) 851-3594
Herbert.Bolton@usda.gov

Hazard Communication Standard

Safety Data Sheets

Contents

Overview 7-1-1
OSHA Requirements 7-1-1

Overview

Safety data sheets (SDS) provide information about hazardous chemicals that are used in the workplace. This information is necessary to safely handle hazardous chemicals.

OSHA Requirements

The Occupational Safety and Health Administration (OSHA) requires that the hazards of all chemicals produced or imported be evaluated, and information concerning chemical hazards is communicated to employers and employees by means of a comprehensive hazard communication program. A hazard communication program should include, but **not** be limited to, the following:

- ◆ Developing and maintaining a written hazard communication program for the workplace, including lists of hazardous chemicals present at the workplace
- ◆ Development and implementation of employee training programs regarding hazards of chemicals and protective measures
- ◆ Labeling of containers of chemicals in the workplace, as well as containers of chemicals being shipped to other workplaces
- ◆ Preparation and distribution of SDS to employees and downstream employees

Employers who do **not** produce or import chemicals need only focus on those parts of [29 CFR 1910.1200](#) that deal with establishing a workplace program and communicating information to their workers. Refer to the OSHA Hazard Communication Standard for a general guide for employers to help determine the compliance obligations under the regulation. The Hazard Communication Standard includes the following topics:

- ◆ Becoming familiar with the Rule
- ◆ Identify Responsible Staff
- ◆ Identify Hazardous Chemicals in the Workplace
- ◆ Preparing and Implementing a Hazard Communication Program
 - ❖ Labels and Other Forms of Warning
 - ❖ Safety Data Sheets (SDS's)
 - ❖ Employee Information and Training
 - ❖ Other Requirements
- ◆ Checklist for Compliance
- ◆ Further Assistance

Emergency Aid and Safety

Guidelines for Managing Pesticide Spills

Contents

Introduction	7-2-1
Emergency Spill Procedures	7-2-2
Identify Contacts and Telephone Numbers	7-2-3
Evaluate The Situation: Take Care of People First!!!	7-2-3
Safety and First Aid	7-2-3
Crash Notification	7-2-4
Contamination Control	7-2-5
Notification	7-2-5
Site Security	7-2-7
Cleanup Techniques	7-2-7
Decontamination	7-2-8
Post-Spill Procedures	7-2-9
Disposal of Contaminated Material	7-2-9
Environmental Monitoring	7-2-9
Reporting	7-2-9
Planning for Pesticide Spills	7-2-10
State Hazardous Waste Management Agencies	7-2-11
Accident or Spill Emergency Kit	7-2-11
Safety	7-2-11
Cleanup	7-2-12

Introduction

This document provides instructions for dealing with pesticide spills during program operations. “Pesticide spill” refers to any unplanned spill or leakage into the environment that occurs during storage, use, transport, or disposal of pesticide. Examples include aircraft and surface vehicular crashes, jettisoning pesticide cargoes from the air, and leaks or other equipment failures. After a pesticide spill, the responsible program person should evaluate the situation and begin appropriate corrective measures. Use [Figure 7-2-1](#) to identify your responsible program contact.

The Officer in Charge (OIC), Contracting Officer’s Representative (COR), or other responsible program official should prepare a site-specific plan based on the generic plan, [Emergency Spill Procedures](#). (Refer to [Figure 7-2-1](#) for an abbreviated plan. Make a copy of this Figure, and keep it for your pocket reference.) Prepare the plan before program operations begin by filling in the

names, telephone numbers, and other required information. Specific objectives of each plan include:

- ◆ Protecting people working in the spill area
- ◆ Preventing or minimizing the risk of further pesticide exposure to people, animals, and the environment
- ◆ Cleanup of the area and disposal or detoxification of residual material
- ◆ Notifying Federal, State, and local government officials of the magnitude and details of the pesticide spill
- ◆ Evaluation of the potential impact to the environment based on chemical residues found in environmental components

Responsible Program Contact (Name)

(Work telephone number)

(Home telephone number)
IF A PESTICIDE SPILLS TAKE THE FOLLOWING STEPS:
1. Evaluate. (Take care of people first!!!)
2. Safety and First Aid. The most immediate concern is for the health and well-being of persons in and around the area.
3. Call 911 for fire/rescue squad to obtain medical assistance for injured or contaminated persons.
4. Contamination Control. Consult pesticide label & SDS for appropriate protective clothing and hazards (or CHEMTREC Emergency Hotline (800) 424-9300).

Figure 7-2-1 Abbreviated Spill Plan, Personal Reference Card (Wallet-size)

Emergency Spill Procedures

Use this section as your guide to prepare a site-specific plan for pesticide spills. Please complete the blanks for your specific program. The following is a summary of factors you **must** consider when a pesticide spill occurs (details follow this summary):

- ◆ Identify Contacts and Phone Numbers
- ◆ Evaluate the Situation
- ◆ Safety and First Aid
- ◆ Crash Notification
- ◆ Contamination Control

- ◆ Notification
- ◆ Site Security
- ◆ Cleanup Techniques
- ◆ Decontamination

Identify Contacts and Telephone Numbers

You **must** know who to contact and where to call if a pesticide spill occurs. [Figure 7-2-2](#) identifies preliminary information that you will need in case of an emergency. Fill in the blanks for your site-specific plan.

(Program name)

Responsible Program Contact (Name)

(Work telephone number)

(Home telephone number)

Alternative Program Contact (Name)

(Work telephone number)

(Home telephone number)

Figure 7-2-2 Emergency Contacts for Pesticide Spills

Evaluate The Situation: Take Care of People First!!!

1. Injury/pesticide exposure. Refer to [Safety and First Aid](#).
2. Vehicle or aircraft crash. Refer to [Crash Notification](#).
3. Spill containment. Refer to [Contamination Control](#).

Safety and First Aid

The most immediate concern is for the health and well-being of persons in and around the area.

1. Call **911** for fire/rescue squad to obtain medical assistance for injured or contaminated persons.
2. Evacuate the immediate area, if necessary get upwind.

3. Remove injured people from the area. (Do **not** move a seriously injured person unless absolutely essential because of the risk of further injury.)
4. Consult the pesticide label and/or MSDS for appropriate protective equipment and hazards.
5. Administer first aid as necessary. See the pesticide's SDS or contact the nearest poison control center. [Figure 7-2-3](#) identifies information that you will need in case of an emergency. Fill in the blanks for your site-specific plan.

(Center Name)

(Telephone)

Figure 7-2-3 Poison Control Center

6. Remove contaminated clothing and wash affected area with soap and water. If eyes are contaminated, flush with clean water.
7. If individuals experience pesticide poisoning symptoms (blurred vision, trembling, nausea, etc.) then transport them to the nearest medical emergency facility. [Figure 7-2-4](#) identifies information that you will need in case of an emergency. Fill in the blanks for your site-specific plan.

(Address)

(How to get there)

Figure 7-2-4 Medical Emergency Facility

8. Eliminate sources of ignition (e.g., pilot lights, electric motors, gasoline engines, or smoking) to prevent the threat of fire or explosion from flammable vapors.

Crash Notification

1. If the spill involved a vehicle or aircraft crash, contact the local police (911) as soon as possible.
2. If the spill involved an aircraft crash, notify the nearest Federal Aviation Administration (FAA) office. [Figure 7-2-5](#) identifies information that you

will need in case of an emergency. Fill in the blank for your site-specific plan.

<hr/> <p>(Telephone number)</p>

Figure 7-2-5 Federal Aviation Administration (FAA) Office

Contamination Control

1. Consult the pesticide label and/or SDS for appropriate protective clothing and hazards (**or call the CHEMTREC Emergency Hotline at (800) 424-9300**).
2. Try to contain the spilled pesticide at the original site, and prevent it from entering streams, rivers, ponds, storm drains, wells, and water systems, as follows:
 - A. If possible, reposition the pesticide container to stop further leakage.
 - B. Prevent the spill from spreading by trenching or encircling the area with a dike of sand, sand snakes, absorbent material, soil, or rags.
 - C. If a liquid formulation spills, cover it with absorbent material; however, use absorbent sparingly, since it also becomes hazardous waste. Use **no** more than necessary.
 - D. If a dry formulation spills, securely cover it with polyethylene or plastic tarpaulin to prevent tracking or airborne spreading of dust.

Notification

1. Notify state officials and the PPQ regional office by telephone. Headquarters management will be notified through normal channels.
2. Contact the local Community-Right-To-Know or Emergency Planning Coordinator (often the Fire Marshall). [Figure 7-2-6](#) identifies information that you will need in case of an emergency. Fill in the blanks for your site-specific plan.

<hr/> <p>(Name)</p>
<hr/> <p>(Telephone number)</p>

Figure 7-2-6 Community-Right-To-Know or Emergency Planning Coordinator (Fire Marshall)

3. Call the CHEMTREC Emergency Hotline at **(800) 424-9300**.

4. Notify the USDA-APHIS-PPQ Biloxi Station in Biloxi, Mississippi, at (228) 385-9278.
5. If the spill involves a large area (4 hectares (10 acres) or more) or you judge that it could affect a large area through runoff or other movement, notify the State Fish and Game Department or equivalent through appropriate channels. [Figure 7-2-7](#) identifies information that you will need in case of an emergency. Fill in the blank for your site-specific plan.

<hr/> <p>(Telephone number)</p>

Figure 7-2-7 Fish and Game Department

6. If animal poisoning may occur, notify the Regional Veterinary Services (RVS) Office. [Figure 7-2-8](#) identifies information that you will need in case of an emergency. Fill in the blank for your site-specific plan.

<hr/> <p>(Telephone number)</p>

Figure 7-2-8 Regional Veterinary Services (VS) Office

7. If the spilled product is a Comprehensive Environmental Response, Compensation, and Liability Act (CERCLA) classified hazardous substance, or a Superfund Amendments and Reauthorization Act of 1986 (SARA) Title III classified extremely hazardous substance, spills of active ingredient exceeding the reportable quantities may be reportable.
8. If you are unsure as to reporting under CERCLA or SARA, look at the product's SDS or call the National Response Center at **(800) 424-8802** for CERCLA, and for SARA call **(800) 535-0202**.
9. Notify your Regional Safety and Health Coordinator. [Figure 7-2-9](#) identifies information that you will need in case of an emergency. Fill in the blank for your site-specific plan.

<hr/> <p>(Telephone number)</p>

Figure 7-2-9 Regional Safety and Health Coordinator

Site Security

Secure the spill site from unauthorized entry by roping off the area and posting warning signs. If necessary, request assistance from local police. [Figure 7-2-10](#) identifies information that you will need in case of an emergency. Fill in the blank for your site-specific plan.

<hr/> <p>(Telephone number)</p>

Figure 7-2-10 Local Police

Cleanup Techniques

The following are general techniques. Consult local hazardous waste officials, the pesticide's label, or its SDS to determine specific cleanup and disposal techniques. Refer to [State Hazardous Waste Management Agencies](#) for a list of local hazardous waste officials. [Figure 7-2-11](#) identifies information that you will need in case of an emergency. Fill in the blanks for your site-specific plan.

<hr/> <p>(Name)</p>
<hr/> <p>(Telephone)</p>

Figure 7-2-11 Local Hazardous Waste Official

Adequate cleanup of spilled pesticides is essential to minimize health or environmental hazards. When cleaning pesticide spills, **NEVER WORK ALONE**. Be sure to ventilate the area and use appropriate protective equipment. Clean up dry spills (dusts, wettable powders, granular formulations) as follows:

- ◆ Clean up liquid spills by placing an appropriate absorbent material (floor-sweeping compound, sawdust, sand, etc.) over the spilled pesticide. Work the absorbent into the spill using a broom or other tool to force the absorbent material into contact with the pesticide. Collect all spent absorbent material and place into a properly labeled metal drum for disposal.
- ◆ Collect the pesticide and place it in heavy-duty plastic bags. Secure and label the bags, properly identifying the pesticide and possible hazards. Set the bags aside in a secured area for disposal.

- ◆ Immediately cover powders, dusts, or granular materials with polyethylene or plastic tarpaulin to prevent them from becoming airborne. If outside, weight the tarp ends, especially the end facing into the wind. Begin cleanup operations by rolling up the tarp while simultaneously sweeping up the spilled pesticide using a broom and shovel or dust pan. Avoid brisk movements to keep the dry pesticide from becoming airborne. When practical, lightly sprinkle the material with water to minimize dust. Always use an approved dust mask or respirator when working with dry pesticide materials.

Depending on the pesticide, the size of the spill, and local conditions, you may need to remove the top 1-inch layer of contaminated soil with a shovel and dispose of it.

Decontamination

As soon as practical, decontaminate crashed aircraft, wrecked vehicles, and pavements. See the pesticide's SDS or label for specific instructions. For aircraft, coordinate with investigating officials and FAA authorities. For automobile wrecks, coordinate with appropriate law enforcement agencies or investigative bodies.

Chlorine bleach, caustic soda (lye, sodium hydroxide) detergents, or burnt or hydrated lime effectively decontaminate most spill areas (see appropriate SDS for precautions when using these substances).

CAUTION

Use bleach or lye, but **never** both together since this combination may liberate poisonous chlorine gas. Lye or lime readily decomposes many pesticides, especially the organophosphates, and carbamates. Clean up and remove as much of the spilled pesticide as possible prior to applying any decontaminate. Allow 1 to 6 hours reaction with the decontaminate before using an absorbent material.

Spread decontaminates thinly and evenly over the spill area. Then, lightly sprinkle the area with water to activate the decontaminate. Repeat the cleanup procedures until all the spilled pesticide is removed.

Clean all equipment used for spill cleanup with detergent and appropriate decontaminates. Collect all used decontaminates and rinse water and place them in labeled metal drums. Place clothing and gloves that **cannot** be decontaminated in the drums for proper disposal.

It may also be necessary to completely remove and dispose of contaminated porous materials.

If pesticides have leaked or spilled on the soil, removal of the visibly contaminated soil (top 1-inch) may be required using a shovel. In such cases,

place the contaminated soil in metal drums for disposal. Chemical analysis of monitoring samples may govern removal of additional soil.

Post-Spill Procedures

Disposal of Contaminated Material

You may contact the pesticide's manufacturers for specific instructions regarding their product. Also contact the State or Federal EPA office with jurisdiction over the pesticide spill location about disposal, and consult with the U.S. Department of Transportation (DOT) prior to shipping/transporting across state lines. Shipping by licensed transporters may be required.

In general, place contaminated materials in sealed leak-proof metal disposal drums. Label all drums properly and dispose of in an approved hazardous waste disposal facility (incinerator, landfill site, etc.) under current EPA or State permit. The pesticide's labeling and MSDS contain specific information concerning disposal.

Environmental Monitoring

After cleanup and disposal, if the pesticide spilled into the environment, collect environmental monitoring samples. Contact USDA-APHIS-PPQ Field Operations and request an Environmental Monitoring Coordinator if you need help with sample collection.

Reporting

Report information regarding pesticide spills in accordance with the program's specific monitoring plan, and as required by state and federal law. In general, reports should include:

1. Detailed map with the site of the pesticide spill clearly marked.
2. Information on location, time, spill area, terrain, pesticide spilled, how spill occurred, and how managed.
3. Any other information the writer deems pertinent to the pesticide spill.

Upon completion of the chemical analyses, S&T will report its findings and include the spill residue data in its programmatic environmental monitoring report and distribute as appropriate.

Planning for Pesticide Spills

Pesticides vary in toxicity as described in the pesticide's labeling and SDS. Actions taken following an accidental spill will depend upon the pesticide toxicity involved. Always consult the labeling and SDS for your program's pesticides when planning for spills. Ensure that the telephone number of the local poison control center is on your plan.

The Environmental Protection Agency (EPA) under the Federal Insecticide, Fungicide, and Rodenticide Act (FIFRA), Resource Conservation and Recovery Act (RCRA), and CERCLA or Superfund are responsible for enforcing safe pesticide use and disposal to most states. States may, therefore, acquire primary responsibility for determining pesticide spill, cleanup, and disposal procedures.

Not all states will perform or react to pesticide spills in the same way. Therefore, the Port Director or COR should assist with cleanup, sample collection, sample analysis, securing affected area, etc. The Port Director or COR **must** monitor such activities to assure PPQ that the responsible parties take proper actions during and after a spill. Keep in mind that legal actions as a result of a pesticide spill may place liability on the cooperating Federal agency.

Program Managers should inform the PPQ Assistant Regional Director's office of procedures to follow when pesticide spills occur within their jurisdictions so they may support field operations when needed. The Port Director, COR, or Senior Staff Officer for any given PPQ operation is responsible for implementing pesticide spill procedures. These officers **must** be familiar with these guidelines and should make contingency plans for such pesticide spills in advance of field operations.

Useful information for completing your spill plan is found in the appendices to these guidelines. Include copies of the SDS (obtainable from the manufacturer) for your program's pesticides in your spill plan.

State Hazardous Waste Management Agencies

Consult local hazardous waste officials, the pesticide’s label, and its SDS when a pesticide spill occurs to determine specific cleanup and disposal techniques.

Refer to the [EPA website Links to Hazardous Waste Programs and U.S. State Environmental Agencies](#) for a list of State waste management agencies.

Accident or Spill Emergency Kit

The Port Director, COR, or their designee should have available a fully supplied pesticide emergency spill cleanup/decontamination kit with instructions for its use. The kit will have the label designation “For Use in Handling and Cleanup of Accident Pesticide Spills Only.”

Responsible officials should use their discretion as to what items will be stored in vehicles for immediate use. The following items should be immediately available for responding to a pesticide spill:

Safety

- ◆ First aid kit—bus and truck kit, (GSA #6545-00-664-5312), or equivalent
- ◆ Fire extinguisher, 5-lb. size for class A, B, C fires

Cleanup

- ◆ One shovel, square-point, “D” handle (GSA 5120-00-224-9326, or equivalent)
- ◆ Twenty-five large, heavy-duty plastic bags with ties (GSA 8105-00-848-9631, or equivalent)
- ◆ Two pairs, unlined vinyl rubber boots
- ◆ Four pairs, disposable coveralls
- ◆ One 5-gallon water container
- ◆ Four pairs, unlined vinyl rubber gloves
- ◆ Two approved respirators with approved pesticide canisters (Self-contained breathing apparatus **must** also be available in operations where methyl bromide is utilized.)
- ◆ One broom and dust pan
- ◆ One pint bottle of liquid detergent
- ◆ Two scrub brushes (GSA 7920-00-068-7903, or equivalent)
- ◆ One plastic cover or tarpaulin (to cover dry spills) (GSA 8135-00-529-6487)
- ◆ Twenty-five pound bag, absorbent material (GSA 7930-00-269-1272), or sweeping compound, sawdust, “kitty litter,” or other absorbent materials
- ◆ One large metal or heavy-duty plastic garbage can with removable cover for storing contaminated materials for later disposal

NOTICE

Use this can to store the spill kit materials during transport.

- ◆ Several sand snakes should be kept in storage areas

Obtain many of these items through the GSA Federal Supply System or from a local hardware store.

Equipment

Contents

Thermal Conductivity Gas Analyzers	8-1-2
Instrument Description	8-1-2
Drierite [®]	8-1-4
Ascarite [®]	8-1-5
Instrument Standardization	8-1-5
Operation Procedures	8-1-6
Maintenance	8-1-8
Repair and Calibration	8-1-8
Infrared Spectroscopy Gas Monitoring Device	8-1-9
General Operation	8-1-11
Calibration and Service	8-1-13
Contact Information	8-1-13
Respiratory Protection	8-1-13
Gas Detector Tubes or Gas Samples	8-1-13
Principles of Operations	8-1-14
Volatilizer	8-1-14
Air Velocity Measuring Instruments	8-1-17
Anemometer	8-1-17
Auxiliary Pump	8-1-18
Manometers	8-1-19
Open-Arm Manometer	8-1-19
Digital Manometer	8-1-21
Magnehelic [®] Pressure Gage	8-1-22
Mityvac Hand-Held Vacuum Pump	8-1-23
Usage	8-1-23
Phosphine Detector	8-1-23
PortaSens Phosphine Detector	8-1-23
Photo Ionization Detector	8-1-24
Principles of Operations	8-1-24
Description	8-1-24
Calibration	8-1-24
Certified Precision Thermometers: Calibration Guidelines	8-1-24
Water Trap	8-1-25
Electrochemical Gas Sensor and Pyrolyzer	8-1-26
Fans—Introduction and Aeration	8-1-27

Thermal Conductivity Gas Analyzers

The thermal conductivity gas analyzer (T/C) is a portable instrument specifically designed to determine the concentration of gases under a tarpaulin or within a chamber during a fumigation. These fumigation gases include methyl bromide (MB) and sulfuryl fluoride (SF).

Instrument Description

Currently, there is one company that manufactures USDA-approved T/C instruments used during a PPQ-monitored fumigation. The Fumiscope® (Figure 8-1-1) Models D, 4.0, 4.2, and 5.1 are manufactured by [Key Chemical and Equipment Co., Inc.](#)

The Fumiscope® is lightweight, portable, and completely contained in a compact metal case. It contains a thermal conductivity cell, scale, gas pump, range switch, and gas flow meter. A gas drying tube is also included. For large enclosures, an auxiliary pump may be needed.

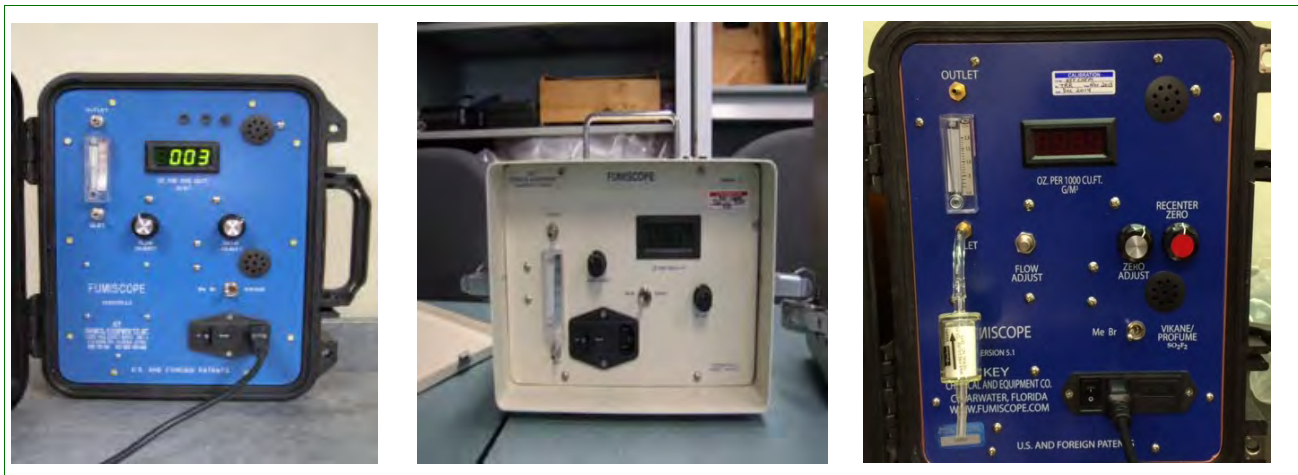

Figure 8-1-1 Fumiscope® Models D, 4.0, and 5.1

Inlet

The inlet tube connector is the gas inlet for the instrument. The sampling lines are 1/4" inner diameter (I.D.) and are connected to the inlet through the drying tube.

Flow Rate Meter

The flow rate meter indicates the gas flow rate in “simulated cubic feet per hour (SCFH).” **Note:** The flow rate should always be read at the middle of the ball.

Flow Rate Adjustment

The flow rate adjustment dial controls the air or gas flow rate by adjusting the pump. After connecting to the gas sampling line, adjust the flow rate upward until it reads exactly 1.0 SCFH.

Scale or Digital Display

The scale or digital display indicates the concentration of the fumigant in ounces per 1,000 cubic feet (milligrams per liter or grams per cubic meter). Record the gas concentration reading only after this meter stabilizes, which may take a minute or more (depending on the length of the tubing and whether an auxiliary pump is being used). Digital Fumiscope® models can indicate a range from 0 to 2,999 ounces per 1,000 cubic feet.

Zero Adjustment

The zero adjustment knob is used to adjust the display to zero after the instrument has warmed up for at least 20 minutes. Set the Fumiscope® to zero prior to taking a reading and after each reading.

The Model 5.1, has two knobs used to zero the display. The “Recenter Zero” red knob acts as a coarse zero adjustment and the “Zero Adjust” knob acts as a fine zero adjustment. (See [Figure 8-1-2](#).) Adjust the red “Recenter Zero” knob first to bring the display as close to zero as possible. Then adjust the “Zero Adjust” knob to set the unit on zero.



Figure 8-1-2 Fumiscope® Model 5.1

Line Switches

Line switches control the electrical supply to the pump and scale.

Fumigant Selector Switch

The fumigant selector switch (Fumiscope®) changes the display to register either methyl bromide or sulfuryl fluoride (Vikane®).

Exhaust Outlet

Always connect an exhaust line to the exhaust outlet to carry gas away from the instrument and operator. When using the T/C unit in confined or poorly ventilated areas, recirculate the exhaust gas back to the fumigation space or exhaust it to the outside.

Drying Tube

Use drying tubes (filter tube) with a prepared chemical for removing certain contaminant gases or vapors that interfere with correct fumigant concentration readings. The tubes will contain a desiccant, such as Drierite® (granules of anhydrous calcium sulfate), or Ascarite® (sodium hydroxide). Both are available from scientific supply houses. **Never mix Drierite® and Ascarite® in the same tube.**

When a drying tube is used, place a thin layer of glass wool or aquarium filter wool at the bottom and top of the tube to prevent small particles from sifting into the T/C unit. Using absorbent cotton or similar materials is **not** recommended. Cotton tends to pick up moisture and to become matted, and once matted, the cotton may restrict normal air flow, thus adversely affecting the T/C unit's operation.

Mount the drying tube *vertically* so the gas mixture moves through the drying material and does **not** pass over the top. The gas mixture will pass over the top of the drying tube when the tube is mounted horizontally (lengthwise).

Drierite®

Always use anhydrous calcium sulfate (Drierite®) to remove moisture from the gas sample. Insert the drying tubes in the gas sampling line just before the inlet connection. Drierite® should be fresh and frequently changed to ensure correct readings. Drierite®, blue in color when dry, turns pink when moisture is absorbed. Replace the Drierite® when most of it has turned pink. In extremely high moisture conditions, two Drierite® tubes can be connected in tandem. Close drying tube openings when **not** in use.

Ascarite®

T/C gas analyzers are sensitive to a number of gases other than MB. For example, CO₂ may be troublesome when fumigating fruit where kerosene heaters are placed under the tarpaulin to raise pulp temperatures, or with plant material packed in peat moss or subsoil. Correct MB gas concentration readings may be obtained if a CO₂ absorbent is used in the gas sampling line before the air-gas mixture enters the T/C unit. A CO₂ absorbent that can be used is Ascarite®. Observe the poison warning labels on the containers when using Ascarite®. Tubes containing Ascarite® should be clearly labeled, “Warning—Avoid contact with skin, eyes, and clothing.”

WARNING

During a fumigation of living plant products, such as plants, plant material, logs, wood and wood products, use tubes containing Ascarite® to remove carbon dioxide from gas samples. Discard used Ascarite® per label instructions. Connect the Ascarite® tube between the Drierite® tube and the sample inlet. **Never mix Drierite® and Ascarite® in the same tube.** Replace Ascarite® when the granules begin to aggregate or become moist.

Because a chemical reaction will occur, **never** use Ascarite® when taking readings of SF.

Instrument Standardization

Instrument standardization is the first and basic operation. In order to standardize the instrument, do the following:

1. Connect the instrument to an electrical outlet with proper voltage and set the pump and meter switches to “on”; if inoperable, check fuse (replacements—Little Fuse or Buss #3AG 1/2 Amp.—should be kept on hand).
2. Attach the drying tube to the inlet port.
 - A. Give the instrument a tightness test.
 - B. A tightness test can be accomplished by placing a finger over the inlet of the drying tube; if the tubing and connections are tight, the flow ball in the flow meter should then fall to zero.
3. Warm up the instrument for 20 to 30 minutes

NOTICE

The manufacturer recommends that the analyzer be kept at the same temperature as the fumigated site. It may take up to two hours for the analyzer to acclimate if moved from extreme temperatures.

4. Adjust the gas flow rate to one SCFH by adjusting the flow rate knob.

- A. If the flow rate knob is turned counterclockwise too far, the pump will emit noises and cease to operate properly.
 - B. When properly adjusted, the flow ball should float at the center mark, or slightly below it, on the calibrated glass cylinder.
 - C. The pump now draws dry, fresh air through the T/C cell; the air enters via the inlet on the face of the instrument, passes through the cell, and leaves through the exhaust outlet.
5. Turn the zero adjustment knob to obtain a zero reading on the meter.
- A. To obtain a stable zero reading, several additional adjustments during the first few minutes may be necessary.
- If using Model 5.1, adjust the “Recenter Zero” red knob first, then adjust the “Zero Adjust” knob to zero.

Standardization is now complete and readings can be made of fumigant-air mixture drawn through the unit. At this point, it may be necessary to replace the desiccant.

The difference in the thermal conductivity of the fumigant-air mixture as compared with fresh air is measured electrically and indicated on the meter as concentration readings in ounces of gas per 1,000 cubic feet. T/C units used in PPQ **must** be calibrated for MB and/or SF by the manufacturer or an approved outside contractor prior to use. When fumigations are under even a small vacuum, readings will **not** be accurate.

Operation Procedures

Because of the variety of fumigation situations, some adjustments may be necessary to meet specific needs. Nevertheless, this outline should be helpful in establishing correct operational procedures.

The proper use of the T/C unit is discussed under two headings:

- ◆ [Selecting Operational Site](#)
- ◆ [Measuring Gas Concentrations](#)

Selecting Operational Site

The T/C unit should be at least 30 feet upwind from the fumigation site to allow the operator to function **without** the fear of accidental exposure to gas and to allow for easy exit in an emergency. It should be close enough to the fumigation site to avoid using unreasonable lengths of sampling lines, to allow for constant surveillance of the fumigation during testing, and to avoid interference with other activities in the area. Avoid excessive wiring length. When T/C unit readings in multiple locations are necessary, see that each location is the best available.

The T/C unit should be supported on a sturdy, level surface, outside the traffic pattern, and protected from wind, rain, excessive cold, and in hot weather, sun. In some cases, temporary shelter, such as a tarpaulin cover, may be adequate. The gas concentration readings indicated by the T/C unit may be inaccurate unless the unit is placed in an area that is approximately the same temperature as the gas mixture in the enclosure being fumigated. If the temperature of the gas mixture within the fumigated enclosure is approximately equal to that of the ambient air outside the enclosure, the gas concentration readings indicated by the T/C unit's meter will be generally more accurate. If there are great differences between the two temperatures, water vapor may condense inside the gas sampling leads. Such condensation, if desiccant is saturated, can result in a lower than normal T/C meter reading, thus leading to the unnecessary addition of fumigant to compensate for the apparent shortage. Therefore, if vapor condensation appears inside the gas sampling leads, purge the line and move the T/C unit to a new location where the ambient temperature approximates that of the enclosure.

Most T/C units operate on 110 to 120 volts alternating current (AC). T/C units operating on 210 to 220 volts AC on direct current (DC) are available for overseas or other assignments, as necessary. A converter is required to use DC. Keep extension wiring and gas sampling line length to a practical minimum and raise extension wiring above floor level when feasible.

Measuring Gas Concentrations

As a protection for the cell and the pump of T/C units, **use a drying tube filled with Drierite® at all times.**

When taking gas concentration readings, first warm up the unit for at least 20 to 30 minutes depending on ambient temperatures. Then turn on the pump and adjust the gas flow meter to a 1.0 SCFH flow. Turn the zero adjustment knob to obtain a zero reading on the meter. If using Model 5.1, adjust the "Recenter Zero" red knob first, then adjust the "Zero Adjust" knob to zero.

The unit is now ready to measure gas samples drawn through labeled gas sampling lines from the area being treated. The meter will indicate gas concentrations in ounces per 1,000 cubic feet (grams per cubic meter).

NOTICE

If monitoring lines are stored outside, water may accumulate in the lines after heavy rainfall.

If you observe water or suspect that there may be water in the sampling lines, install a water trap. See [Water Trap](#) on page 8-1-25 for details on obtaining and using water traps.

Equipment

Thermal Conductivity Gas Analyzers

Connect the gas sampling line to the Drierite® tube using 1/4 inch ID polyethylene tubing. Allow sufficient time to draw a true sample. With 150 to 200 feet of 1/4 inch ID tubing and a temperature of 70 °F, a sufficient amount of time will be approximately 7 minutes. Stations equipped with small auxiliary pumps can draw a sample through the same length of tubing in 12 to 15 seconds.

Wait until the analyzer reaches the maximum reading (at least 30 seconds) and does **not** move for 30 seconds. Ensure the flow meter still reads 1.0 SCFH. This is the gas reading. Record this reading on the PPQ Form 429A, 429B, and in the electronic 429 database.

Disconnect the sampling line and allow the pump to draw uncontaminated air through the T/C cell. The instrument should return to zero; however, it may be necessary to re-zero the analyzer. Again, ensure that the flow meter reads 1.0 SCFH. **Always re-zero the analyzer before taking the next reading.**

After taking the final reading at the end of the fumigation, thoroughly purge the unit by disconnecting it from the gas sampling line and allowing the pump to draw fresh air through the instrument for several minutes.

Maintenance

If it is to function properly, the T/C unit requires the same attention as any other equipment. While the instrument is designed specifically for field use, the components, particularly the meter, may be damaged easily. To maintain an instrument capable of accurate gas concentration readings, careful handling is essential. If repairs are needed and are extensive, or the parts are **not** readily available, there will be a delay in returning the instrument. Should the need for a substitute T/C unit occur, the port should be prepared to obtain one from another source.

Repair and Calibration

Under normal service, the T/C unit will hold its calibration for a considerable length of time. To ensure all units are providing accurate gas concentration readings, recalibrate T/C units at least annually; calibrate more often if use is frequent.

Send the instrument by insured delivery service (i.e., Federal Express, United Parcel Service, U.S. Postal Service priority mail) to one of the contractors listed below. To prevent damage, the unit **must** be well-packed and shipped in a durable, tamper-proof box.

Prepare a memorandum to accompany each instrument explaining the need for sending the unit. Ensure all instruments are shipped with a proper return address, name of a contact person, and telephone number. The T/C unit will be

calibrated for MB only, unless the PPQ office requests calibration for SF.
Notify the contractor if Ascarite® will be utilized during the readings, as the T/C must be calibrated using this type of absorbent. All port locations will be responsible for payments to contractors.

Use one of the following contractors for repair and calibration:

Cardinal Professional Products (BPA #45-6395-3-2871)
2675 W. Woodland Drive
Anaheim, CA 92801-2628
Phone: (714) 761-3292
<http://cardinalproproducts.com/>

Key Chemical and Equipment Co. (BPA #45-6395-3-2872)
13195 49th St. North
Unit A
Clearwater, FL 33762
Phone: (727) 572-1159
Fax: (727) 572-4595
<http://www.fumiscope.com/>

Infrared Spectroscopy Gas Monitoring Device

Infrared spectroscopy is an accurate and efficient method for measuring methyl bromide gas concentrations. There is one unit currently approved for use by PPQ. The MB-ContainIR™ is manufactured by Spectros Instruments Inc., Hopedale, MA, and will be referred to in this document as the “Spectros.” The Spectros is lightweight (9 pounds; 4 kg) and battery operated.



Figure 8-1-3 Spectros Methyl Bromide Monitor

The Spectros uses a technology known as “non-dispersive infrared technology” (NDIR). NDIR is based on Beer’s Law (also known as Lambert-Beer Law or Beer-Lambert-Bouguer Law) that relates the absorption of light to

Equipment

Infrared Spectroscopy Gas Monitoring Device

the properties of the material through which the light is traveling. The Spectros is **not** affected by other volatile organic compounds such as carbon dioxide, eliminating the need for Ascarite®. Other benefits of the unit include:

- ◆ Audible and visible programmable alarm
- ◆ Battery powered and portable
- ◆ Measuring range for methyl bromide 0-240 oz./1000 ft³ (g/m³)
 - ❖ Accuracy 0.08 oz./1000 ft³ (g/m³)
 - ❖ Sensitivity 0.16 oz/1000 ft³ (g/m³)
- ◆ Operating temperature 32 °F — 122 °F (0 °C — 50 °C)
- ◆ Variable temperature compensation

The information and guidelines in this chapter are based on the Spectros Inc. Operation and Maintenance Guide. Contact [Spectros Instruments](#) for more detailed operating instructions or technical assistance.

Important points to remember:

NOTICE

- ◆ Install a water trap and particulate filter in-line between the fumigation site and the monitoring unit. See [Respiratory Protection](#) on page 8-1-13.
- ◆ This monitor is **not** and **should not** be used as a worker safety clearance device.
- ◆ This monitor is **not** set up to evaluate, test, or determine readings for other approved fumigants that PPQ uses, such as **phosphine** or **sulfuryl fluoride**.
- ◆ Do **not** operate the monitor in the presence of flammable liquids, vapors, or aerosols.
- ◆ Do **not** use soap and water to clean the monitor; use a dry cloth to clean the monitor.
- ◆ Maintain proper care and storage of the monitor when **not** in use.
- ◆ Use **only** batteries supplied by the factory.
- ◆ Operate the monitor at all times in a horizontal position. Operating the monitor in a vertical position may cause inaccurate measurements.
- ◆ **Never** operate this unit at or above 6,562 feet (2,000 meters).
- ◆ The monitor **must** be maintained free of moisture or other contaminants.
- ◆ Always place supplied filter on the gas sample line between the monitor and the sampling line.
- ◆ Always ensure that the direction of flow is correct for the supplied filter before using the monitor.
- ◆ Cap the ends of the gas sampling lines to prevent the possibility of mists, aerosol, oil, water, dust, or other contaminants being drawn into the monitor.
- ◆ The maximum length of the gas sampling line is 1,000 feet.
- ◆ The monitor does **not** require Drierite® if the measuring range is greater than 2 oz./1000 ft³.
- ◆ Return the monitor to the manufacturer for calibration every 6 months.

General Operation

Prior to taking gas concentration readings, follow the guidelines in Chapter 2-4, [Fumigants—Methyl Bromide—Tarpaulin Fumigation, Conducting the Fumigation](#), to ensure proper installation of gas sampling lines and circulation fans.

If **not** using direct current, ensure that the battery for the Spectros is fully charged before the fumigation begins. When using the Spectros in battery mode, press the “test” button and observe the number of LEDs that light up.

- ◆ A red flashing LED on the battery indicates a low battery. Recharge the battery per manufacturer instructions before using for gas monitoring. Charging time is 3-4 hours for a fully discharged battery pack.
- ◆ Four green LEDs on the battery indicate that the unit is fully charged and monitoring can begin. A fully charged battery pack will power the monitor for 8-10 hours.

Water Trap

Install a water trap and particulate filter in-line between the fumigation site and the monitor in order to keep water from damaging the monitor. See [Water Trap](#) on page 8-1-25 for more information.

Gas Sample Line

Using 1/4-inch flex tubing, connect the gas sample line to the monitor by pushing the tubing onto the gas sample port on the front of the monitor. The gas sample line can be up to 50 feet in length and should be free of kinks or obstructions. If the gas sample line is longer than 300 feet, the instrument will display “FAULT” on the display screen. Ensure that the end of the line is positioned to prevent moisture or water intake, or utilize the filter element.

Purge Air Line

Connect the purge air line to the monitor by pushing the tubing onto the purge air port on the left side of the monitor. The purge line can be up to 100 feet maximum in length and should be in an area of fresh air. Ensure that the end of the line is positioned to prevent moisture or water intake, or utilize the filter element.

Exhaust Line

Connect the exhaust line to the monitor by pushing the tubing onto the exhaust port’s barbed fitting. The exhaust line can be up to 50 feet in length and should terminate outside the building. Ensure that the end of the tube is positioned to prevent moisture or water intake.

Measuring Gas Concentration

To turn on the monitor, lift the shield in front of the handle and press the red power ON/OFF toggle switch. Allow the monitor to warm up for 15 minutes.

The WARM UP screen is displayed and the ON light (green) will blink. After 15 minutes the ON light will stop blinking and glows steadily.

The data display screen will show:

ZONETEMP – enter temperature of the area being monitored in °C. The zone is the area where the monitor is being operated, rather than the temperature of the commodity undergoing fumigation.

The factory default temperature setting is 25 °C.

NOTICE

If the monitor is turned off at any time during operation, the monitor will run through an entire 15 minute WARM UP cycle, regardless of how long the monitor has been running.

After the warm up period, the Data Display Screen will read either MEASURE or PURGE in the upper left corner of the screen.

MEASURE indicates the monitor is actively measuring gas. The measurement is shown in the lower section of the screen. The monitor measures up to 240g/m³ with a sensitivity of 0.16g/m³.

The measurement (reading) should stabilize (stop) before recording the reading. This may take one or more purge cycles depending on the length of the gas sample line.

The measurement cycle will run for 4 minutes before the purge cycle begins. When the display shows “PURGE,” the monitor is resetting its infrared detector to baseline. The PURGE cycle runs for 10 seconds.

A zero reading indicates the concentration measured is below the lower limit of detection of 0.77g/m³ (200ppm approximately).

NOTICE

If kinks or obstructions occur in the line, the monitor may **not** function properly.

Check for crimped sampling lines. Make sure nothing is restricting the flow of either the inlet sample air, purge air, or the exhaust (return sample line).

Calibration and Service

Return the Spectros to the manufacturer every 6 months for a calibration check and service. Contact Spectros to obtain a Service Request Form and Return Materials Authorization Number (RMA). Ship the unit using an insured carrier.

Contact Information

Spectros

Spectros Instruments, Inc.
17-D Airport Road
Hopedale, MA 01747
Phone: (508) 478-1648
Fax: (508) 590-0262
<http://www.spectrosinstruments.com/>

USDA-APHIS-PPQ-S&T-TMT

USDA-APHIS-PPQ-S&T-TMT
13601 Old Cutler Road, Bldg. 63
Miami, FL 33158 USA
Phone: 305-278-4877
Fax: 305-278-4898
email: ppqmt@usda.gov

Respiratory Protection

Fumigation or other treatments conducted under the monitored conditions stated in this manual and other program manuals are safe operations. The Occupational Safety and Health Administration (OSHA) has ruled that employees with possible exposure to pesticides (including fumigants) **must** be provided adequate respiratory protection from such exposure. Refer to Appendix G for detailed respiratory protection information. USDA employees may also refer to Chapter 11 in the *APHIS Safety and Health Manual* website for additional respiratory information.

Gas Detector Tubes or Gas Samples

Use gas detector tubes to measure low level concentrations of MB, SF, and PH.

Principles of Operations

Special pumps are used to draw a measured sample (usually 100 milliliters) of an air-gas mixture. The sample is drawn through one or two detector tubes where a chemical reaction with the tube reagent takes place, creating a stain. The length of the stain is proportional to the concentration of the gas. Measure the length of the stain by using a calibrated chart or by simply reading the number from a scale printed on the glass tube.

Gas detector tubes are manufactured with a constant reagent weight with corrections for variations in the diameter of each tube. Detailed operational instructions accompany the equipment.

The detector tubes are specific for each fumigant and are usually available from several manufacturers. However, it is advisable to use the pump supplied by the manufacturer of the tube used. In an emergency, detector tubes available under the trade names Auer, Draeger, Gastec, Kitagawa, and Mine Safety Appliances can be used with pumps manufactured by any of these companies provided they draw 100 milliliters. Because of the different diameters of the tubes sold by each manufacturer, adapters may be necessary. The Kitagawa pump uses a removable, stainless steel micro-orifice to reduce the rate of air flow through many of its detector tubes. This provides greater accuracy in the chemical reaction within the tube. Remove the orifice when using tubes manufactured by other companies.

To increase shelf life, store tubes under refrigeration. Before each day's use, test pumps as provided by instructions with each kit and make repairs as necessary. Keep spare parts and operational instructions with each kit for use as needed.

When many samples **must** be drawn to a common point during a large fumigation, an auxiliary pump can be used. If only one sample lead is involved, it may be necessary to pull the fumigant through the line by pumping several times. A used tube can be inserted in the pump to determine when the fumigant has reached the pump.

Volatilizer

Methyl bromide **must** pass through a volatilizer (vaporizer) to ensure adequate conversion of liquid MB to gaseous MB. Introduce the volatilized fumigant into or near to the air flow of the gas introduction fan. When 5 pounds or less of MB are used, a simple volatilizer can be made with a 25-foot coil of 3/8 inch O.D. (outer diameter) coiled copper tubing immersed in a container of hot water.

When amounts greater than 5 pounds are to be used, the copper tubing used in the volatilizer **must** consist of a minimum of 50 feet of 1/2 inch O.D. coiled copper tubing immersed in a container of hot water.

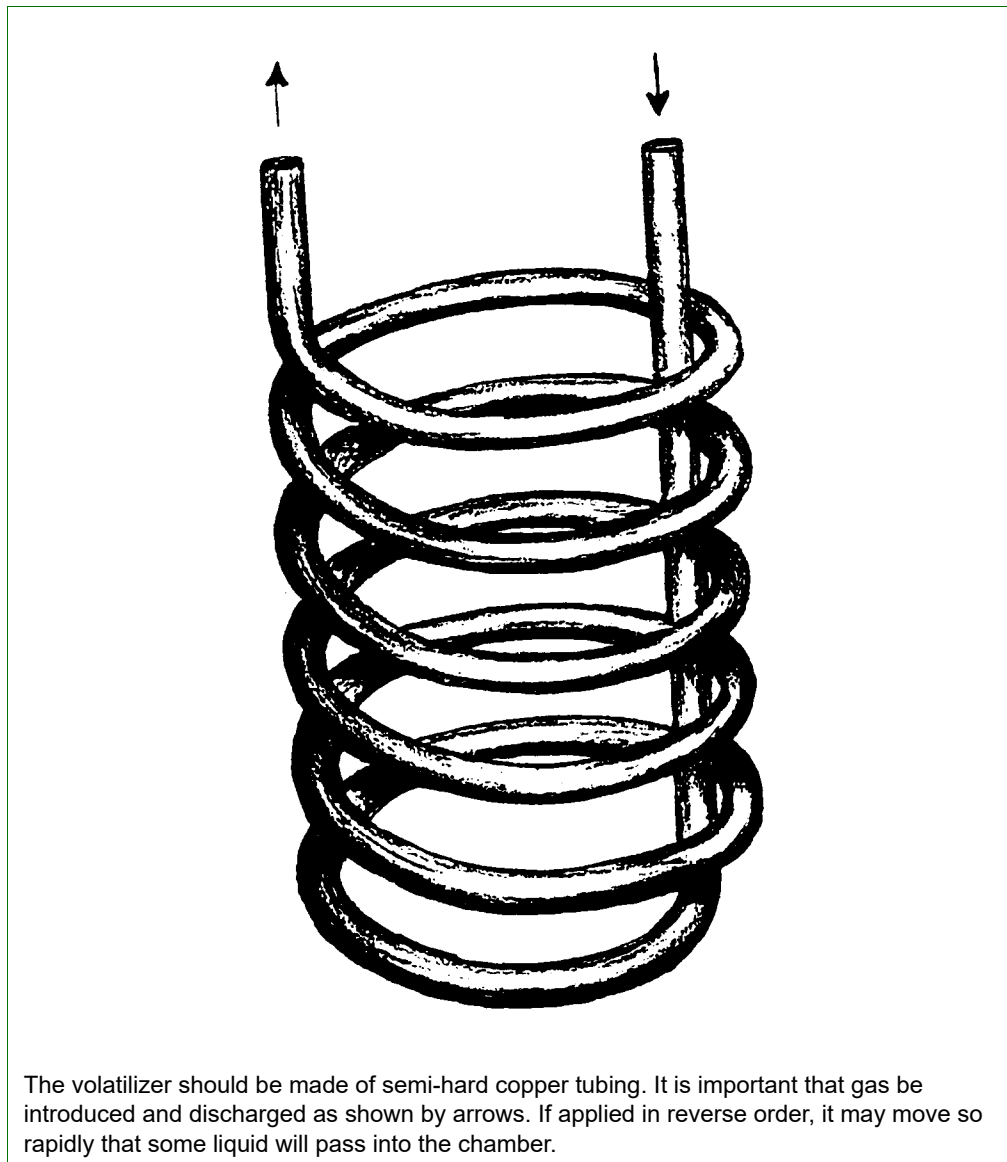

Figure 8-1-4 Methyl Bromide Volatilizer Coil

Heat the water in all sizes of volatilizers to temperatures of 200 °F or above with a minimum of 150 °F during the gas introduction process. Insert a calibrated thermometer into the water to determine the water temperature. Calibrate the thermometer once a year by an approved calibration company. Present written documentation of calibration at the time of fumigation.

The line that runs from the MB cylinder to the copper tubing in the volatilizer **must** be a 3000 PSI hydraulic high pressure hose with a 3/8 inch I.D. (inner

diameter) or larger. The line that exits the volatilizer and runs into the enclosure **must** be a 350 PSI tubing with a 1/2 inch I.D. or greater.

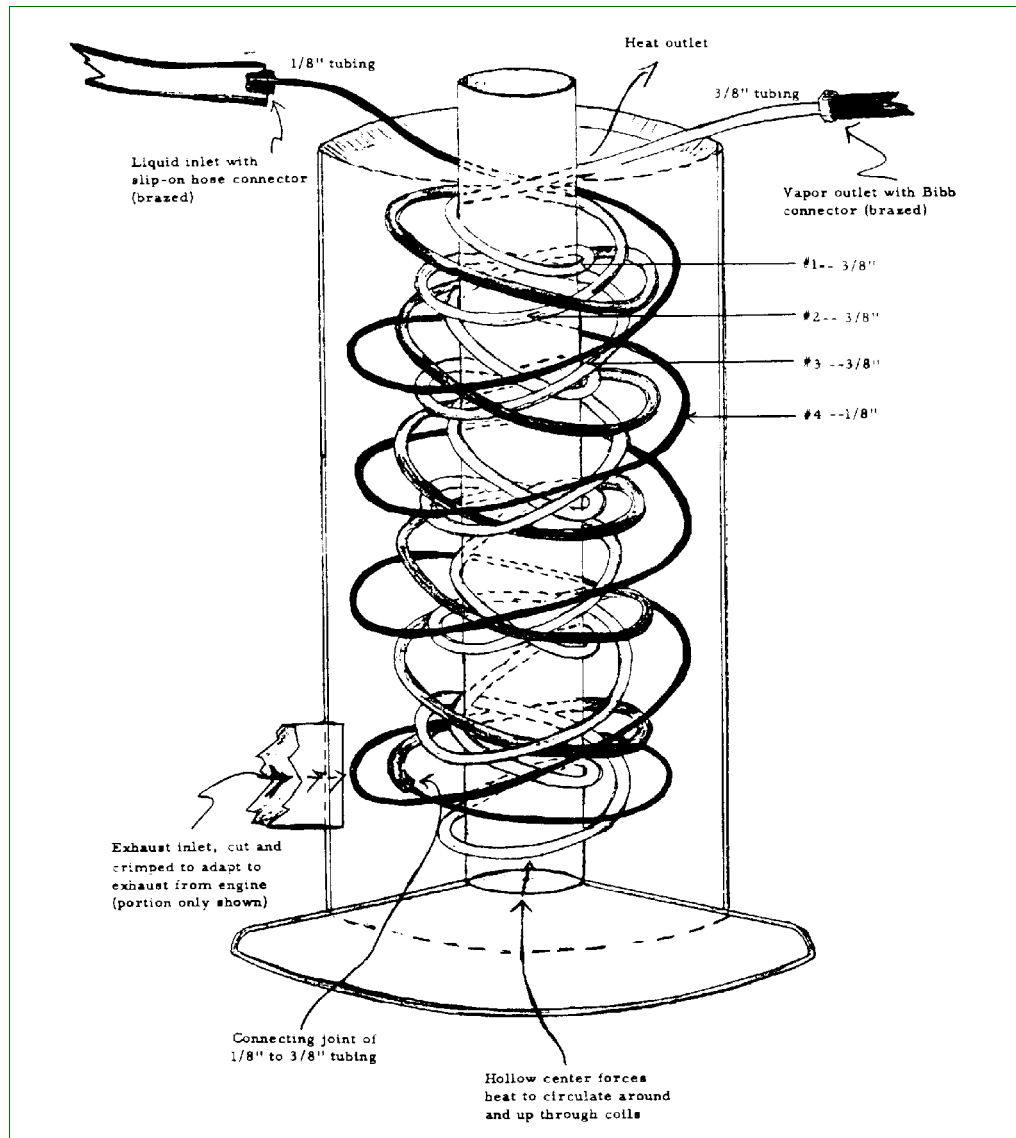

Figure 8-1-5 Tubing Specifications

Introduce the fumigant through the tubing at the rate of 3 to 4 pounds of gas per minute. The gas introduction tube should feel hot to the touch as a good measure of satisfactory vaporization.

Air Velocity Measuring Instruments

Anemometer

Use an anemometers (wind meters) to measure the air velocity of circulation fans and air curtains. Wind meters **must** be approved by the USDA-APHIS-PPQ-S&T-TMT. Submit specifications of unapproved wind meters to S&T-TMT for approval. Refer to Appendix E for a list of approved models.

Fan Velocity

Measure the cubic feet per minute (cfm) of a fan by placing the anemometer 12 inches from the face of the fan to be tested. Take a minimum of three readings; one from the center, and the others from points toward the outside of the fan. Average the readings. If an anemometer is used, each measurement should be for 1 minute, thereby giving the result in feet per minute. If a wind speed indicator is used, the reading in miles per hour should be converted to feet per minute by multiplying the miles per hour by 5,280 and dividing by 60.

Area of the fan is calculated by first measuring the radius (R)—distance from the center of the fan to the end of a blade. Formula for area is $\text{Pi} \times R^2$ where Pi is equivalent to 3.14. The final answer should be given in cfm. Therefore, if the radius of the blade is given in inches and **not** feet, the factor 1/144 **must** be multiplied in to convert square inches to square feet. The full formula would be: Feet per minute $\times R^2$ (in inches) $\times 3.14 \times 1/144 = \text{cfm}$.

EXAMPLE If average air movement is 1,600 feet for 1 minute from a fan having a 7 inch radius (14 inch diameter), the calculations are as follows:

$$1,600 \times 7^2 \times 3.14 \times 1/144 = 1,700 \text{ cfm (approximate)}$$

Air Curtain Velocity

Measure the velocity of air curtains with an anemometer. Anemometers used in this capacity **must** meet the following specifications:

- ◆ Calibrated once a year to NIST calibration and certification
- ◆ CE certified with a certificate of conformity
- ◆ Digital
- ◆ Hand-held
- ◆ +/- 3 percent accuracy
- ◆ Record in at least one of the following units with the resolution in parenthesis:
 - ❖ Beaufort (0.1)
 - ❖ ft/min (1)

- ❖ mph (1)
- ❖ m/s (0.1)
- ❖ km/h (0.1)
- ❖ knots (0.1)
- ◆ Tested to NIST-Traceable standards with a written certificate of tests

Auxiliary Pump

During large-enclosure fumigations, it is necessary to take numerous gas concentration readings from various locations throughout the enclosure. Thus, some sample leads may be over 200 feet long. Pump the fumigant to the sampling point before making an accurate concentration reading using an auxiliary pump. If the inspector **must** rely on the pump provided with the gas sampler or T/C unit to pull the fumigant, a great deal of time will be needed between readings.

Because it pumps the fumigant from many areas and keeps a constant pull, the auxiliary pump will reduce sampling time to only the reading time. Constructing a unit is relatively simple. Petcocks capable of accepting sample leads are tapped and soldered to a short length of pipe. The pipe is connected to the suction side of the pump. The pipe acts as a manifold. Opening or closing the petcocks allows the gas samples to be drawn as required. Connect an exhaust line of sufficient length to the pump to ensure the fumigant is removed from the sample area.

It is important that all soldering be done in such a manner as to provide gastight construction of the petcocks. The pump should be of sufficient size to pull 1 cubic foot per minute through all of the leads on the manifold. Therefore, the more leads, the higher the required capacity of the pump. Mount the whole unit on a board large enough to keep vibration to a minimum. Keep the unit weight down to allow easy transport.

Disconnect each sampling line from the auxiliary pump in turn, and close the petcock. Attach the line to the T/C unit or gas detector. Obtain a reading and reconnect the line to the auxiliary pump and open the petcock.

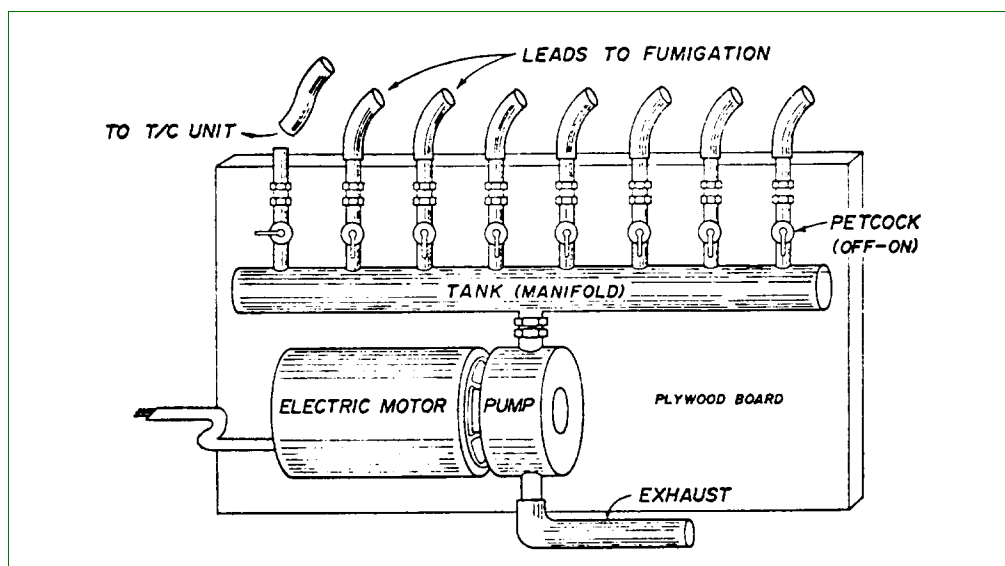

Figure 8-1-6 Auxiliary Pump

Manometers

Manometers are devices that can be used to measure pressure during a pressure-leakage test in a fumigation chamber. Pressure is defined as a force per unit area. Refer to [Appendix E](#) for a list of commercial suppliers. Contact S&T-TMT¹ for approval of manometers not list in Appendix E. Select a model that encompasses the pressure range needed for pressure-leakage testing and that displays the results in the required units of measurement. Consult the operation manual of the specific manometer for complete information on operation and maintenance.

Manometers offer a selection of pressure units, such as inches of water (inch WC), pounds per square inch (PSI), bar (g), mbar (mb), pascal (Pa), kilopascal (kPa), ounce square in (ozin²), inches of mercury (in Hg), millimeters of mercury (mmHg), foot water (ft. H₂O), centimeters of water (cmH₂), and kilograms centimeters squared (kgcm²).

Open-Arm Manometer²

The most accurate way to measure low air pressure is to balance a column of liquid of known weight against it and measure the height of the liquid column so balanced. The units of measure commonly used are inches of mercury (in. Hg), using mercury as the fluid and inches of water (in. w.c.), using water or oil as the fluid.

1 USDA-APHIS-PPQ-S&T-TMT, 13601 Old Cutler Road, Bldg. 63, Miami, FL 33158 USA, Phone: 305-278-4877

2 The information included in this section has been extracted from the [Dwyer-inst.com website](http://Dwyer-inst.com).

An open-arm manometer is typically a U-shaped tube partially filled with liquid. The tube may be of glass or transparent plastic tubing. A ruler calibrated in millimeter (mm) divisions or carefully measured lines on a background is used to measure the difference in level of the liquid in the two arms (or the level in one arm).

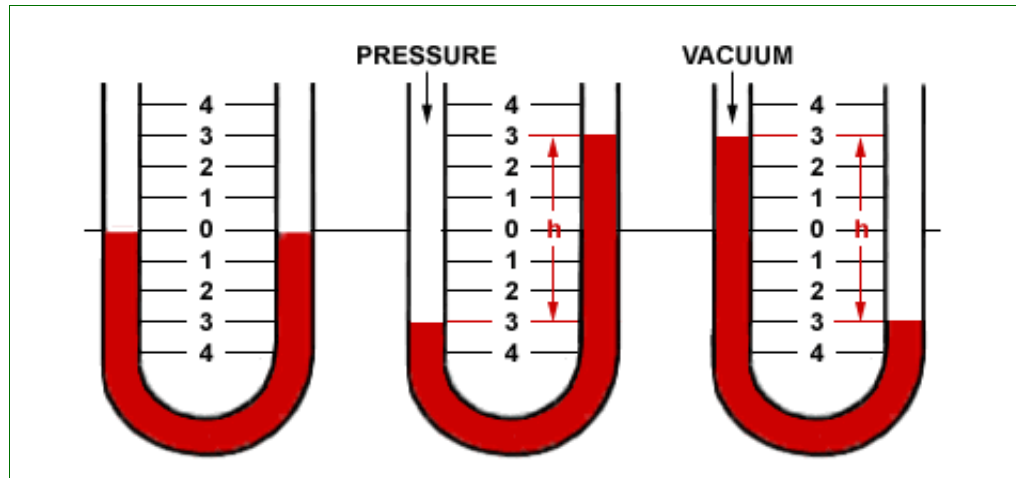

Figure 8-1-7 Example of Pressure Measurement in an Open-arm Manometer

As displayed by the picture the center in [Figure 8-1-7](#), when positive pressure is applied to one arm, the liquid is forced down in that arm and up in the other. The difference in height, “h,” which is the sum of the readings above and below zero, indicates the pressure.

The picture of the manometer on the right in [Figure 8-1-7](#) shows that when a vacuum is applied to one arm, the liquid rises in that arm and falls in the other. The difference in height “h,” which is the sum of the readings above and below zero, indicates the amount of vacuum.

No manometer can be read more accurately than the accuracy with which the specific gravity of the liquid inside the manometer is known. The liquid **must** also have good “wetting” characteristics and be capable of forming a consistent, well-shaped meniscus in the indicating tube to facilitate accurate, repeatable readings.

The liquid used also affects the operating range of the manometer. Mercury, being 13.6 times the weight of water, will move 1/13.6th the distance water will move in response to a given pressure. Red gage oil, having a specific gravity of 0.826 which is lighter than water, will move about 1.2 times farther than water in response to a given pressure. This obviously, expands the scale for easier, more precise reading.

Manometers for use with water are furnished with a fluorescent green concentrate which, when added to water, serves as a setting agent and a dye to improve the consistency and visibility of the meniscus for easier, more accurate readability. Because of increased accuracy and consistency, S&T-TMT recommends the use of red gage oil manometers.

Digital Manometer

The operating instructions for digital manometers differ depending on the manufacturer and/or model, but all have the following basic functions:

1. Use fresh, new batteries before testing begins. Replace as needed.
 - A. Turn the power on.
 - B. Re-zero the manometer immediately before use.
 - C. Connect the positive port to the tubing of the component and vent to the opposite port to the atmosphere to measure single positive pressure.
 - D. Connect the lower positive pressure to the negative port and the higher positive pressure to the plus port to measure differential positive pressure. The manometer calculates the difference.
 - E. Add positive pressure to the chamber. When the manometer reaches the highest pressure, begin recording time. Stop time when the low pressure is reached. Record the low and high pressures.

Electronic Manometer

When a fumigant is volatilized in a chamber at atmospheric pressure, a positive pressure is created, which may then be continuously reduced by leakage of the air-fumigant mixture. PPQ-approved chambers **must** be sufficiently tight to retain the fumigant during the exposure period. A manometer is used during the pressure leakage test for NAP chamber certification and the vacuum leakage test for vacuum chamber certification. (See [Pressure-leakage Test for NAP Fumigation Chambers](#) on page 6-3-9, and [Certification Standards](#) on page 6-2-4 for detailed descriptions of the certification processes.) Use the following example for the most accurate way to determine the pressure measurement from a manometer.

EXAMPLE Referencing [Figure 8-1-8](#), the left arm of the open-arm manometer measures 8 mm below zero. The right arm measures 7 above zero. The sum of the two measurements equals 15 mm. Therefore, in this example, 15 mm is the actual reading.



Figure 8-1-8 Example of U Tube Manometer

Magnehelic® Pressure Gage³

Magnehelic® Pressure Gages can be used instead of U-Tube or digital manometers. The most common gages have units in “inches of water”, Pascals, or PSI units. The most common unit is “inches of water”.

The operating instructions for Magnehelic® Pressure Gages differ depending on the manufacturer and/or model, but all have the following basic functions:

- ◆ Select an operating location that is free from excessive vibration and ambient temperature below 140 F. Avoid direct sunlight. Sensing lines have no length restrictions. Do not restrict the lines.
- ◆ Calibrate the gage with the diaphragm in a vertical position. To ensure maximum accuracy, mount the diaphragm in a vertical position during operation.
- ◆ Zero the gage after installation using the external zero adjust screw.
- ◆ Connect tubing from the source of the pressure to either of the two high-pressure pots. Plug the port not used. Vent one or both low-pressure pots to the atmosphere.
- ◆ Calibrate once per year if it is used less than 10 times per year.
- ◆ Calibrate every four months if it is used at least 10 times per year.

³ Dwyer-Inst.com

Mityvac Hand-Held Vacuum Pump

Detect blocked monitoring leads by using a Mityvac® hand-held vacuum pump (for supplier, see Appendix E).

Usage

1. Prior to introducing fumigant, connect the Mityvac® hand-held vacuum pump to a monitoring lead.
2. Squeeze the handle on the Mityvac® unit; if the lead is blocked, a vacuum will be indicated on the vacuum gauge of the Mityvac® unit (squeeze the handle two or three times for monitoring leads longer than 25 feet; the Mityvac® hand-held pump has the capacity to attain and hold 25 inches of Hg vacuum and a minimum of 7 psi pressure).
3. Disconnect the Mityvac® hand-held pump from the monitoring lead, and repeat this procedure for each monitoring lead (connect monitoring leads to the gas analyzer prior to fumigant introduction).

Phosphine Detector

PortaSens Phosphine Detector

Description

Historically, measuring phosphine has been done using detector tubes specific for phosphine (see [Gas Detector Tubes or Gas Samples](#)). The high cost associated with these tubes has been a deterrent for many ports.

A more accurate, portable unit is recommended for use during phosphine fumigations. The PortaSens, available from Analytical Technology, Inc. (ATI), is a portable, battery-operated instrument for measuring various gas concentrations in ambient air. The instrument can be ordered specifically for phosphine in the 0 to 1,000 ppm range. Ranges from 0 to 1 ppm are available also, along with other configurations. The PortaSens is a complete measuring instrument containing an electrochemical sensor, sampling pump, flow cell assembly, microprocessor electronics, and a two-line, backlit LCD display. The unit is powered by a rechargeable NiCad battery located in the handle, with the charger connection located at the bottom of the handle. Refer to the manufacturer's product literature for detailed operation instructions.

Photo Ionization Detector

The Photo Ionization Detector (PID) is a portable vapor and gas detector that detects a variety of organic compounds. For methyl bromide, the PID has been used both as a leak detector to locate fumigant leakage around chambers, application equipment, and temporary enclosures, and as a safety device around fumigation sites.

Principles of Operations

The PID is used to indicate the presence and approximate concentration of methyl bromide or other volatile organic compounds (VOC's) present. This is accomplished by photo ionization that occurs when an atom or molecule absorbs light of sufficient energy to cause an electron to leave and create a positive ion. Because PID's measure all VOC's, careful attention **must** be paid to the presence of other VOC's in the air. Other VOC include, but are **not** limited to, cigarette smoke, perfume, soap, and exhaust fumes from vehicles.

Description

All PID's have the same basic construction, differing only in detail by the various manufacturers. Each has an ultraviolet lamp that emits photons that are absorbed by the compound in an ionization chamber. Electrodes collect the ions that are produced. The current that is generated provides a measure of the concentration.

Calibration

PID's are typically calibrated using isobutylene, a stable gas with a slightly pungent odor. This gas is easy to handle and can be stored at high pressure, allowing calibration bottles to be used for calibrations many times. The PID manufacturer supplies a reference manual that describes calibration procedures and provides a list of correction factors.

For a partial list of manufacturers, refer to [Appendix E](#).

Certified Precision Thermometers: Calibration Guidelines

Before a thermometer can be used as a calibration standard, it **must** meet the following requirements from an approved facility. All calibration facilities **must** be approved by USDA-APHIS-PPQ-S&T-TMT, 13601 Old Cutler Road, Bldg. 63, Miami, FL 33158; Phone (305) 278-4877.

A list of current approved facilities can be accessed in [Appendix E](#).

- ◆ Accuracy **must** be 0.1 °C or less for Centigrade thermometer or 0.1 °F or less for Fahrenheit thermometer

- ◆ ASTM thermometers **must** have five or more calibration points. Non-ASTM precision thermometers **must** have calibration points at the treatment temperature.
- ◆ The calibration certificate issued by calibration facility lists one to five calibration points, tabulated corrections for each calibration point, serial and test identification number of the NIST standard, and explanatory notes defining the conditions under which the test results were made.
- ◆ The thermometer **must** be calibrated annually or as designated by S&T-TMT. Thermometers with expired calibration certificates **cannot** be used in quarantine treatments.
- ◆ Thermometer **must** be calibrated against standards that are approved by the National Institute of Standards and Technology (NIST)

Water Trap

When there is a large difference in temperature between the fumigation and monitoring locations, water vapor may condense inside the gas monitoring leads. Additionally, if monitoring leads are stored outside, water may accumulate in the leads after heavy rainfall. If water is observed or suspected in the monitoring leads, use forced air to remove water from the leads. If water is observed in the water trap, remove the water from the trap and use forced air to remove water from the leads.

Install a water trap in-line between the fumigation site and the monitor in order to keep water from damaging the monitor. If using an infrared spectroscopy analyzer to monitor gas concentrations, also install a particulate filter. A particulate filter is **not** needed if monitoring gas concentrations with a T/C.

Contact your National Treatment Program Manager to obtain information about acquiring a water trap.

Equipment

Electrochemical Gas Sensor and Pyrolyzer

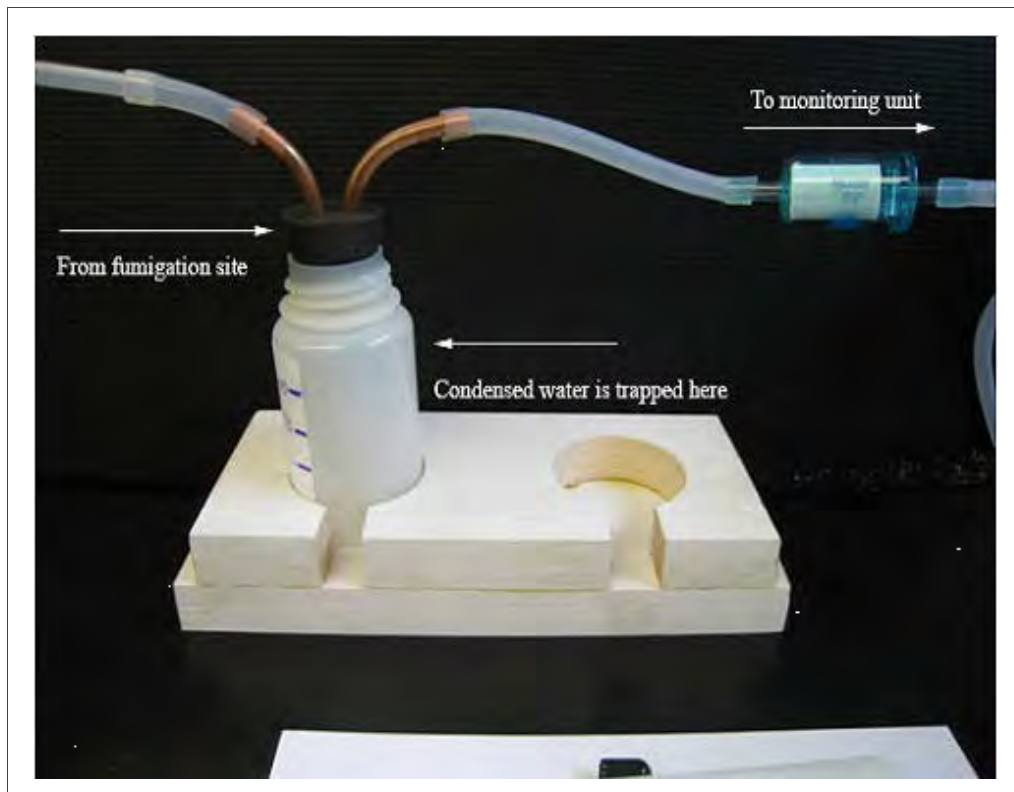

Figure 8-1-9 Example of a Water Trap

Electrochemical Gas Sensor and Pyrolyzer

Pyrolyzer technology combined with a renewable electrochemical sensor cell provides sensitive and specific methyl bromide monitoring. Currently, there is one unit approved for use during PPQ fumigations. The Air Check Advantage methyl bromide monitor is manufactured by PureAire Monitoring Systems, Inc.⁴

The Air Check system may be permanently installed in a fumigation facility and can continuously and remotely sample over distances of up to 100 feet.

The system has the following features:

- ◆ Accuracy: $\pm 10\%$ or reading
- ◆ Dimensions: 10" W x 7.0" H x 7.0" D
- ◆ Operating Temperatures: -4 to 122 °F (-20 to +50 °C)
- ◆ Power requirements: 24 VDC 2.0 amp

⁴ PureAire Monitoring Systems, Inc., 557 Capital Drive, Lake Zurich, IL 60047. PH: 888-788-8050; pureairmonitoring.com

- ◆ Repeatability: $\pm 10\%$ of full scale
- ◆ Response time: within 60 seconds
- ◆ Sensor range: 0-10 ppm (other ranges are available)
- ◆ Sensor type: renewable electrochemical cell that is field rechargeable
- ◆ User selectable alarms
- ◆ Weight: 10 pounds (4.5 kg)

Initial Startup

Refer to the [Air Check Advantage Manual](#) for more detailed operating instructions.

Allow at least a 2 hour warm up period. The sensor's zero will stabilize during this warm up period.

NOTICE

The monitor is designed for continuous 24/7 operation. Do **not** power down unless the monitor will be stored for a long period of time.

If, after the 2 hour warm up period, the LED display is reading a positive PPM, then adjust the LED display to zero.

Connect a gas sampling tube to the monitor and begin gas sampling readings. The MB gas is drawn through a pyrolyzer where it is heated and converted into bromine that is detected by the electrochemical sensor.

Maintenance and Calibration

Ensure that the fumigator replaces the electrochemical cell every 6 months and replaces the pyrolyzer and O-rings when damaged. Ensure that the fumigator calibrates the sensor every 3 months under continuous MB exposure or every 6 months under normal use.

Fans—Introduction and Aeration

When fumigating with methyl bromide, fans must be operational during gas introduction and for at least 30 minutes after the gas has been introduced. Fans are also required for aeration. Do not use plastic fans.

Fans must be:

- ◆ Constructed of steel
- ◆ Capable of circulating the equivalent cubic feet per minute (cfm) of the total volume of the enclosure, but a minimum of 2,500 cfm
- ◆ Minimum of 18 inches in diameter

Equipment

Fans—Introduction and Aeration

Require the fumigator to turn on all fans before gas introduction to ensure they are functioning properly. Refer to Figure 8-1-13 for an example of an approved fan.



Figure 8-1-10 Example of an Approved Fan

Glossary

Acronyms, Abbreviations, and Terms

absorbed dose. quantity of radiation (energy) absorbed per unit of mass of a specified target

aeration, active. the use of fans or any other mechanical devices to aerate or ventilate the treatment area

aeration, passive. non-mechanical ventilation (i.e. removing tarpaulins, opening doors or windows) of the treatment area

aeration buffer zone. an area that extends from the point of methyl bromide emissions from the treatment area to a specified distance where access is limited

a.i. active ingredient

anemometer. wind meter

APHIS. Animal and Plant Health Inspection Service

CERCLA. Comprehensive Environmental Response, Compensation, and Liability Act

CHEMTREC. 24-hour emergency telephone service for spills

copra. dried coconuts and whole coconuts **without** the husk

COR. contracting officer's representative

dose mapping. measurement of the absorbed dose distribution within a process load through the use of dosimeters placed at specific locations within the process load

dosimeter. a devices that when irradiated, exhibits a quantifiable change in some property of the device which can be related to absorbed dose in a given material using appropriate analytical instrumentation and techniques

dosimetry. a system used for determining absorbed dose, consisting of dosimeters, measurement instruments and their associated reference standards, and procedures for the system's use

DOT. U.S. Department of Transportation

EPA. Environmental Protection Agency

exhaust duct/stack. a duct or stack used to exhaust methyl bromide from the treatment area

external Feeder. pest that normally inhabits the outside or outer part of its host; contrast with hitchhiker and internal feeder

FAA. Federal Aviation Administration

FIFRA. Federal Insecticide, Fungicide, and Rodenticide Act

g. grams

garbage. all waste material that is derived in whole or in part from fruits, vegetables, meats, or other plant or animal (including poultry) material, and other refuse of any character whatsoever that has been associated with any such material

Gy. gray

hitchhiker. pest transported by chance and **not** found inhabiting its host; contrast with external feeder

internal feeder. a pest that normally inhabits the inside or inner part of its host; contrast with external feeder

ionizing radiation. charged particles and electromagnetic waves that, as a result of physical interaction, create ions by either primary or secondary processes

irradiation. treatment with any type of ionizing radiation

ISPM. International Standards for Phytosanitary Measures; international measures developed by the International Plant Protection Convention

m. meter

manometer. a device used to measure pressure during a pressure leakage test

mbar. millibar; mb; a unit of pressure

MB. methyl bromide

mg. milligram

mg/L. milligrams per liter

minimum absorbed dose. the localized minimum absorbed dose within the process load (Dmin)

mmHg. millimeters of mercury; a measure of pressure

NIOSH. National Institute for Occupational Safety and Health

OIC. officer-in-charge

OSHA. U.S. Occupational Safety and Health Administration

Pa. pascal; a unit of pressure

PH. phosphine

PID. photoionization detector; a portable vapor and gas detector that detects a variety of organic compounds

PSI. pounds per square inch

PEL. permissible exposure limit

ppb. parts per billion

ppm. parts per million

PPQ. Plant Protection and Quarantine

quarantine material interceptions (QMI). APHIS-regulated materials confiscated from passenger and crew or found in the Customs and Border Protection passenger and crew clearance areas, including bathrooms. QMI is **not** Regulated Garbage.

radura. internationally recognized symbol used to indicate when a food product has been irradiated

SCBA. self contained breathing apparatus

Glossary

Acronyms, Abbreviations, and Terms

SDS. safety data sheet (replaces Material Safety Data Sheet)

SF. sulfuryl flouride

STEL. short-term exposure limit

TLV. threshold limit value

treatment area. the structure, area, or space, which is or was enclosed or sealed, to contain fumigant during fumigation and continuing until the commodity or structure is moved or released

treatment buffer zone. an area surrounding a treatment area during the treatment period where access is limited

USDA. U.S. Department of Agriculture

volatilizer. vaporizes liquid methyl bromide into a gaseous state

Appendix A

Forms

Contents

APHIS Form 2061 (Residue Sample for Food or Feed Product)	A-2
APHIS Form 205-R, Instructions and Worksheet for Calibrating Portable Temperature Sensors	A-3
APHIS Form 206-R, Test of the Accuracy of the Permanent RTD Sensors Installed in Hot Water Tanks	A-4
APHIS Form 207-R, Sensor Location Diagram Fruit Weights and Pulp Temperatures	A-5
APHIS Form 208, Performance Test for Mango Hot Water Immersion Tank	A-6
Calibration of Temperature Probes (Cold Treatment)	A-7
Location of Temperature Sensors in Containerized Cargo (Cold Treatment)	A-8
PPQ Form 429A, Fumigation Record	A-9
PPQ Form 429B, Fumigation Record (Without Tarpaulin)	A-12
PPQ Form 519, Compliance Agreement	A-17
PPQ Form 523, Emergency Action Notification	A-20
PPQ Form 449-R, Temperature Recording Calibration Report	A-30
PPQ Form 203, Foreign Site Certificate of Inspection and/or Treatment	A-32
PPQ Form 556, In Transit Cold Treatment Clearance Report	A-35
Worksite Specific Respiratory Protection Plan—Template	A-36

Appendix A Forms

APHIS Form 2061 (Residue Sample for Food or Feed Product)

APHIS Form 2061 (Residue Sample for Food or Feed Product)

The APHIS Form 2061 has been removed from this manual. Contact the Manuals Unit to obtain a copy and instructions for use.

APHIS Form 207-R, Sensor Location Diagram Fruit Weights and Pulp Temperatures

SENSOR LOCATION DIAGRAM FRUIT WEIGHTS AND PULP TEMPERATURES			USDA-APHIS	1. DATE
2. NAME OF FACILITY		3. TANK NUMBER	4. TEST NUMBER	
INSTRUCTIONS				
<p>Show sensor numbers, and their approximate location within each basket. (Use three or four sensors per basket.) Place an asterisk (*) beside fruit pulp sensors. (Use one or two per test.) Indicate, by arrow, the direction of water flow in the tank. (If the tank is of an unusual shape (e.g., round) please use the reverse side of this form to draw a diagram, showing position of baskets and sensors.)</p>				
BASKET NO. 1	BASKET NO. 2	BASKET NO. 3	BASKET NO. 4	BASKET NO. 5
5. WEIGHT (g) OF 10 FRUITS SELECTED AT RANDOM		6. WEIGHT (g) OF 5 LARGEST FRUITS	7. FRUIT PULP TEMPERATURES (Taken at random)	8. NET WEIGHT OF A TYPICAL FIELD CRATE OF MANGOES
				9. NUMBER OF FIELD CRATES PER LOADED BASKET
MEAN WT. =	(g)	MEAN WT. =	MEAN TEMP. =	
10. REMARKS				

APHIS FORM 207-R (OCT 95) (Previous edition is obsolete)

Figure A-3 APHIS Form 207-R, Sensor Location Diagram Fruit Weights and Pulp Temperatures

Location of Temperature Sensors in Containerized Cargo (Cold Treatment)

LOCATION OF TEMPERATURE SENSORS IN CONTAINERIZED CARGO

NAME OF VESSEL _____

CONTAINER NUMBER _____

PROBE 1 _____

PROBE 2 _____

PROBE 3 _____

SIGNATURE: _____ DATE: _____

TITLE: _____

Figure A-6 Location of Temperature Sensors in Containerized Cargo (Cold Treatment)

PPQ Form 429A, Fumigation Record

Use PPQ Form 429A as a station record for all treatments conducted in approved chambers or in temporary enclosures (containers, truck vans, railroad cars, ships, warehouses, or other similar enclosures.)

Complete a paper PPQ Form 429A at the completion of every fumigation. Use the information as a guide to complete the electronic 429 Fumigation Report in the Commodity Treatment Information System (CTIS). The PPQ official **must** record treatment oversight data into the electronic 429 database **within 48 hours** of the treatment being completed or approved by the supervisor. After the electronic fumigation record is completed, the PPQ official **must** file the paper PPQ Form 429A for a minimum of 3 years.

Treatments conducted under temporary enclosures require reporting of minimum gas concentration readings. S&T-TMT tracks MB fumigant usage using the electronic 429 database. Contact ppqctis@aphis.usda.gov to request access.

Appendix A Forms

PPQ Form 429A, Fumigation Record

UNITED STATES DEPARTMENT OF AGRICULTURE ANIMAL AND PLANT HEALTH INSPECTION SERVICE PLANT PROTECTION AND QUARANTINE		FUMIGATION RECORD (WITH TARPAULIN)				1. STATION REPORTING						
						2. PEST AND INTERCEPTION NUMBER						
3. CARRIER		4. ARRIVAL DATE		5. DATE INTERCEPTED		6. ORIGIN						
7. PLACE OF ARRIVAL				8. DATE CONFIRMED		9. PORT OF LADING						
10. FUMIGATION CONTRACTOR				11. DATE FUMIGATION ORDERED		12. COMMODITY						
13. FUMIGATION SITE				14. DATE FUMIGATED		15. QUANTITY						
16. MARKS		17. B/L NUMBER		18. ENTRY NUMBER		19. SHIPPER						
21. FUMIGANT AND TREATMENT SCHEDULE				22. TEMPERATURE		23. GAS ANALYZER (type and serial number)						
				a. SPACE		b. COMMODITY						
24. ENCLOSURE		25. WEATHER CONDITIONS		26. CUBIC CAPACITY		27. TREATMENT UNDER SECTION 18 EXEMPTION						
						<input type="checkbox"/> YES <input type="checkbox"/> NO						
28. NUMBER OF FANS		29. TOTAL CFM'S FANS		30. TIME FANS OPERATED		31. FOOD OR FEED COMMODITY						
						<input type="checkbox"/> YES <input type="checkbox"/> NO						
32. GAS INTRODUCTION		33. AMOUNT GAS INTRODUCED		34. GAS ADDED		35. RESIDUE SAMPLE TAKEN SAMPLE NUMBER						
a. START b. FINISH						<input type="checkbox"/> YES <input type="checkbox"/> NO						
GAS CONCENTRATIONS (gram per cubic meter [oz./1000 cu. ft.]) (To be prepared for fumigations when gas concentration readings are required while treatment is in progress.)												
36. DATE/TIME	37. PLACEMENT OF TEST LINES										38. TIME INTERVAL (from Block 32b)	39. INSPECTOR'S INITIALS
	SPACE			COMMODITY								
	FRONT A	CENTER B	REAR C	D	E	F	G	H	I	J		
40. DETECTOR TUBE READINGS (PPM)												
41. REMARKS						42. CALCULATIONS						
43. INSPECTOR SIGNATURE				44. DATE		45. REVIEWER SIGNATURE				46. DATE		

PPQ FORM 429A
AUG 2018

(Previous edition is obsolete.)

Figure A-7 Example of PPQ Form 429A, Fumigation Record, With Tarpaulin (front)

FUMIGATION WITH TARPAULIN			
NOTE: In preparation for the fumigation and prior to site selection, the officer should have determined (1) the immediate pest risk associated with the infested commodity, (2) the temperature requirements for the fumigation, and (3) the permeability of the packaging.			
MATERIALS			
FUMIGATOR			PPQ
<input type="checkbox"/> Tarpaulin <input type="checkbox"/> Sand Snakes <input type="checkbox"/> Loose Sand <input type="checkbox"/> Burlap / Padding <input type="checkbox"/> Masking Tape <input type="checkbox"/> Spray Adhesive <input type="checkbox"/> Pesticide and Spray Equipment <input type="checkbox"/> Tarpaulin Supports <input type="checkbox"/> Fans (<i>metal</i>) <input type="checkbox"/> Extension Cords <input type="checkbox"/> 2-3 Prong Plug Adapters <input type="checkbox"/> Fumigant with Pesticide Label Attached <input type="checkbox"/> Gas Introduction Line	<input type="checkbox"/> T/C Gas Analyzer (<i>Fumiscope</i>) or Spectros Unit <input type="checkbox"/> Volatilizer <input type="checkbox"/> Heat Supply for Volatilizer <input type="checkbox"/> Aeration Fans with Ducts (<i>introduction and exhaust</i>) <input type="checkbox"/> Sampling Tubes/Lines <input type="checkbox"/> Weight Scales <input type="checkbox"/> Fumigation Warning Treatment Placards <input type="checkbox"/> Self-Contained Breathing Apparatus (<i>SCBA</i>) <input type="checkbox"/> Drierite <input type="checkbox"/> Ascarite <input type="checkbox"/> Approved Air Monitoring Device per Fumigation Label, PID-Photo Ionization Detector	<input type="checkbox"/> Tape Measure <input type="checkbox"/> Thermometer <input type="checkbox"/> Gas Detector Kit and Detector Tubes for Section 18's <input type="checkbox"/> Approved Heaters (<i>non-electrical heating elements</i>) <input type="checkbox"/> Approved Temperature Recording Devices for Treatments Over 6 Hours <input type="checkbox"/> Approved Temperature Sensors for Treatments Over 6 Hours <input type="checkbox"/> Auxiliary Pump or Mighty Vacuum Pump <input type="checkbox"/> PPQ Treatment Manual <input type="checkbox"/> Fans (<i>circulation and introduction</i>)	<input type="checkbox"/> Self-Contained Breathing Apparatus (<i>SCBA</i>) <input type="checkbox"/> PID-Photo Ionization Detector <input type="checkbox"/> Tape Measure <input type="checkbox"/> Thermometer <input type="checkbox"/> Blank PPQ Form 429 <input type="checkbox"/> PPQ Treatment Manual
PREPARATION PROCEDURES <small>(Section III Treatment Manual)</small>			
1. Site Selection <input type="checkbox"/> Ventilated Area <input type="checkbox"/> Sheltered Area <input type="checkbox"/> Impervious Surface <input type="checkbox"/> Non-Work Area <input type="checkbox"/> Proximity to Electrical Source <input type="checkbox"/> Proximity to Commodity 2. Arrangement of Commodity and Equipment <input type="checkbox"/> Stack Size Limitation <input type="checkbox"/> Air, Space, Below, and Between Load <input type="checkbox"/> Placement of Tarpaulin Supports <input type="checkbox"/> Placement of Padding <input type="checkbox"/> Placement of Fans <input type="checkbox"/> Placement of Gas Introduction Line(s) <input type="checkbox"/> Placement of Sampling Tubes/Lines	3. Tarpaulin Enclosure Cover a. Cover <input type="checkbox"/> Condition <input type="checkbox"/> Air Space, Above Load <input type="checkbox"/> Floor Area 30 cm (12") Space Around Load <input type="checkbox"/> Overlap 45 cm (18") Border b. Snakes <input type="checkbox"/> Contact Along Sides <input type="checkbox"/> Contact Around Corners <input type="checkbox"/> Overlap 15 cm (8") Minimum <input type="checkbox"/> Filled and Not Leaking c. Sand <input type="checkbox"/> Perimeter d. Adhesive <input type="checkbox"/> Perimeter 4. Treatment Schedule Determination <input type="checkbox"/> Plant Pest <input type="checkbox"/> Commodity Temperature	<input type="checkbox"/> Space Temperature <input type="checkbox"/> Volume Determination <input type="checkbox"/> Sorptive Commodity <input type="checkbox"/> Amount of Fumigant 5. Fumigant Introduction <input type="checkbox"/> Area Clear of Unauthorized Personnel <input type="checkbox"/> Tarpaulin Condition of Wear <input type="checkbox"/> Fan Operation <input type="checkbox"/> Fumigant Cylinder Weight <input type="checkbox"/> Gas Line Connections <input type="checkbox"/> Volatilizer Heated to 150 Degrees Fahrenheit <input type="checkbox"/> Introduction Rate <input type="checkbox"/> Check for Leaks 6. Safety <input type="checkbox"/> Gas Detection Tests for Leakage <input type="checkbox"/> Wind Sock	7. Concentration Readings <input type="checkbox"/> T/C Gas Analyzer (<i>Fumiscope</i>) or Spectros Unit Calibrated <input type="checkbox"/> Reading Time Intervals <input type="checkbox"/> Gas Distribution <input type="checkbox"/> Maximum/Minimum Readings Taken 8. Aeration (Multiple Stacks) <input type="checkbox"/> Exhaust Fan(s) <input type="checkbox"/> Exhaust Tube(s) <input type="checkbox"/> Exhausted in a Non-Fumigation Area <input type="checkbox"/> Negligible Gas Readings Before Tarpaulin Removed <input type="checkbox"/> PID-Photo Ionization Detector or Other Detection Tests Used During Aeration
PPQ FORM 429A (Reverse)			

Figure A-8 Example of PPQ Form 429A, Fumigation Record, With Tarpaulin (back)

PPQ Form 429B, Fumigation Record (Without Tarpaulin)

Use PPQ Form 429B as a station record for all treatments conducted in containers that meet the conditions in [Fumigants—Methyl Bromide—Special Procedures for Container Fumigations Without a Tarpaulin](#) on page 2-8-1.

Complete a paper PPQ Form 429B at the completion of every fumigation. Use the information as a guide to complete the electronic 429 Fumigation Report in the Commodity Treatment Information System (CTIS). The PPQ official **must** record treatment oversight data into the electronic 429 database **within 48 hours** of the treatment being completed or approved by the supervisor. After the electronic fumigation record is completed, the PPQ official **must** file the paper PPQ Form 429B for a minimum of 3 years.

Treatments conducted under temporary enclosures require reporting of minimum gas concentration readings. S&T-TMT tracks MB fumigant usage using the electronic 429 database. Contact ppqctis@aphis.usda.gov to request access.

UNITED STATES DEPARTMENT OF AGRICULTURE ANIMAL AND PLANT HEALTH INSPECTION SERVICE PLANT PROTECTION AND QUARANTINE		FUMIGATION RECORD (WITHOUT TARPAULIN)				1. STATION REPORTING						
						2. PEST AND INTERCEPTION NUMBER						
3. CARRIER		4. ARRIVAL DATE		5. DATE INTERCEPTED		6. ORIGIN						
7. PLACE OF ARRIVAL				8. DATE CONFIRMED		9. PORT OF LADING						
10. FUMIGATION CONTRACTOR				11. DATE FUMIGATION ORDERED		12. COMMODITY						
13. FUMIGATION SITE				14. DATE FUMIGATED		15. QUANTITY						
16. MARKS		17. B/L NUMBER		18. ENTRY NUMBER		19. SHIPPER						
21. FUMIGANT AND TREATMENT SCHEDULE				22. TEMPERATURE a. SPACE b. COMMODITY		23. GAS ANALYZER (type and serial number)						
24. ENCLOSURE		25. WEATHER CONDITIONS		26. CUBIC CAPACITY		27. TREATMENT UNDER SECTION 18 EXEMPTION <input type="checkbox"/> YES <input type="checkbox"/> NO						
28. NUMBER OF FANS		29. TOTAL CFM'S FANS		30. TIME FANS OPERATED		31. FOOD OR FEED COMMODITY <input type="checkbox"/> YES <input type="checkbox"/> NO						
32. GAS INTRODUCTION a. START b. FINISH		33. AMOUNT GAS INTRODUCED		34. GAS ADDED		35. RESIDUE SAMPLE TAKEN SAMPLE NUMBER <input type="checkbox"/> YES <input type="checkbox"/> NO						
GAS CONCENTRATIONS (gram per cubic meter [oz./1000 cu. ft.]) (To be prepared for fumigations when gas concentration readings are required while treatment is in progress.)												
36. DATE/TIME	37. PLACEMENT OF TEST LINES										38. TIME INTERVAL (from Block 32b)	39. INSPECTOR'S INITIALS
	SPACE			COMMODITY								
	FRONT A	CENTER B	REAR C	D	E	F	G	H	I	J		
40. DETECTOR TUBE READINGS (PPM)												
41. REMARKS						42. CALCULATIONS						
43. INSPECTOR SIGNATURE				44. DATE		45. REVIEWER SIGNATURE				46. DATE		

PPQ FORM 429B JUN 2018 (Previous edition is obsolete.)

Figure A-9 Example of PPQ Form 429B, Fumigation Record, Without Tarpaulin (front)

Appendix A Forms

PPQ Form 429B, Fumigation Record (Without Tarpaulin)

FUMIGATION WITHOUT TARPAULIN			
<p>NOTE: In preparation for the fumigation and prior to site selection, the officer should have determined (1) the immediate pest risk associated with the infested commodity, (2) the temperature requirements for the fumigation, and (3) the permeability of the packaging.</p>			
MATERIALS			
FUMIGATOR		PPQ	
<ul style="list-style-type: none"> <input type="checkbox"/> Masking Tape <input type="checkbox"/> Spray Adhesive <input type="checkbox"/> Pesticide and Spray Equipment <input type="checkbox"/> Extension Cords <input type="checkbox"/> 2-3 Prong Plug Adapters <input type="checkbox"/> Fumigant with Pesticide Label Attached <input type="checkbox"/> Gas Introduction Line <input type="checkbox"/> T/C Gas Analyzer (<i>Fumiscope</i>) or Spectros Unit <input type="checkbox"/> Volatilizer <input type="checkbox"/> Heat Supply for Volatilizer <input type="checkbox"/> Aeration Fans with Ducts (<i>introduction and exhaust</i>) <input type="checkbox"/> Sampling Tubes/Lines 	<ul style="list-style-type: none"> <input type="checkbox"/> Weight Scales <input type="checkbox"/> Fumigation Warning Treatment Placards <input type="checkbox"/> Self-Contained Breathing Apparatus (<i>SCBA</i>) <input type="checkbox"/> Drierite <input type="checkbox"/> Ascarite <input type="checkbox"/> Approved Air Monitoring Device per Fumigation Label, PID-Photo Ionization Detector <input type="checkbox"/> Tape Measure <input type="checkbox"/> Thermometer <input type="checkbox"/> Gas Detector Kit and Detector Tubes for Section 18's <input type="checkbox"/> Approved Heaters (<i>non-electrical heating elements</i>) 	<ul style="list-style-type: none"> <input type="checkbox"/> Approved Temperature Recording Devices for Treatments Over 6 Hours <input type="checkbox"/> Approved Temperature Sensors for Treatments Over 6 Hours <input type="checkbox"/> Auxiliary Pump or Mighty Vac Pump <input type="checkbox"/> PPQ Treatment Manual <input type="checkbox"/> Fans (<i>circulation and introduction</i>) <input type="checkbox"/> Pressure Testing Equipment, Manometer, Sealing Putty, Device or Equipment with Ability to Pressurize a Container 	<ul style="list-style-type: none"> <input type="checkbox"/> Self-Contained Breathing Apparatus (<i>SCBA</i>) <input type="checkbox"/> PID-Photo Ionization Detector <input type="checkbox"/> Tape Measure <input type="checkbox"/> Thermometer <input type="checkbox"/> Blank PPQ Form 429 <input type="checkbox"/> PPQ Treatment Manual
PREPARATION PROCEDURES <small>(Section III Treatment Manual)</small>			
<p>1. Site Selection</p> <ul style="list-style-type: none"> <input type="checkbox"/> Ventilated Area <input type="checkbox"/> Sheltered Area <input type="checkbox"/> Impervious Surface <input type="checkbox"/> Non-Work Area <input type="checkbox"/> Proximity to Electrical Source <input type="checkbox"/> Proximity to Commodity <p>2. Pressure Testing</p> <ul style="list-style-type: none"> <input type="checkbox"/> Use Approved Pressure Testing Equipment <p>3. Arrangement of Commodity and Equipment</p> <ul style="list-style-type: none"> <input type="checkbox"/> Stack Size Limitation <input type="checkbox"/> Placement of Plastic Sheeting Over Commodity Near Introduction Line <input type="checkbox"/> Placement of Fans Inside Container <input type="checkbox"/> Placement of Gas Introduction Lines <input type="checkbox"/> Placement of Sampling Tubes/Lines 	<p>4. Adhesive and Tape</p> <ul style="list-style-type: none"> <input type="checkbox"/> Cover Vents and Door Seals <p>5. Treatment Schedule</p> <p>Determination</p> <ul style="list-style-type: none"> <input type="checkbox"/> Plant Pest <input type="checkbox"/> Commodity Temperature <input type="checkbox"/> Space Temperature <input type="checkbox"/> Volume Determination <input type="checkbox"/> Sorptive Commodity <input type="checkbox"/> Amount of Fumigant <p>6. Fumigant Introduction</p> <ul style="list-style-type: none"> <input type="checkbox"/> Area Clear of Unauthorized Personnel <input type="checkbox"/> Fan Operation <input type="checkbox"/> Fumigant Cylinder Weight <input type="checkbox"/> Gas Line Connections <input type="checkbox"/> Volatilizer Heated to 150 Degrees Fahrenheit <input type="checkbox"/> Introduction Rate <input type="checkbox"/> Check for Leaks by Fumigator 	<p>7. Safety</p> <ul style="list-style-type: none"> <input type="checkbox"/> Gas Detection Tests for Leakage <input type="checkbox"/> Wind Sock <input type="checkbox"/> Self-Contained Breathing Apparatus (<i>SCBA</i>) <p>8. Concentration Readings</p> <ul style="list-style-type: none"> <input type="checkbox"/> T/C Gas Analyzer (<i>Fumiscope</i>) or Spectros Unit Calibrated <input type="checkbox"/> Reading Time Intervals <input type="checkbox"/> Gas Distribution <input type="checkbox"/> Maximum/Minimum Readings Taken <p>9. Aeration (Multiple Containers)</p> <ul style="list-style-type: none"> <input type="checkbox"/> Exhaust Fan(s) <input type="checkbox"/> Exhaust Tube(s) <input type="checkbox"/> Exhausted in a Non-Fumigation Area <input type="checkbox"/> Negligible Gas Readings Before Opening Doors 	<ul style="list-style-type: none"> <input type="checkbox"/> PID-Photo Ionization Detector or Other Detection Tests Used During Aeration
<p>PPQ FORM 429B (Reverse)</p>			

Figure A-10 Example of PPQ Form 429B, Fumigation Record, Without Tarpaulin (back)

Table A-1 Instructions for Completing PPQ Form 429A and PPQ Form 429B

Block	Instruction
1	Fill in the name of the PPQ work station where the fumigation occurs.
2	Fill in scientific name(s) of pest or insert "Precautionary" when fumigation is mandatory as a condition of entry or movement. Include station interception number(s) if fumigation is based on pest findings.
3	Fill in ocean vessel name or aircraft identifying marks.
4	Fill in the date of arrival of the commodity at the port of entry.
5	Fill in the date the pest was intercepted.
6	Fill in the foreign port the commodity originated from.
7	Fill in the US port of arrival.
8	Fill in the date the pest was identified by the specialist.
9	Fill in the port of lading the commodity originated from.
10	Fill in the fumigation contractor performing the fumigation.
11	Fill in the date the fumigation was ordered.
12	Fill in the commodity requiring fumigation. if the commodity is a fruit or vegetable, enter the common name and/or variety. Common names and varieties help track fumigant tolerances.
13	Fill in where the fumigation occurred.
14	Fill in the date the fumigation was completed.
15	Fill in the quantity of fumigated commodity.
16	Fill in any distinguishing marks to identify the fumigated commodity.
17	Fill in the bill of lading information of the fumigated commodity.
18	Fill in the customs entry number of the shipment.
19	Fill in the shipper information.
20	Fill in the consignee information who will receive the commodity.
21	Fill in fumigant (for example: MB, PH, SF), treatment schedule number, dosage rate, and exposure period (MB 4 lbs/1,000 ft ³ for 12 hours).
22	Fill in the initial temperature of the (a) space in the enclosure and (b) commodity temperature. Specify Celsius or Fahrenheit.
23	Fill in the type, model name, and serial number of gas monitoring equipment used (Fumiscope® #1234.)
24	Fill in the enclosure type: chamber, tarpless container, or tarped container. Indicate whether the tarp is single- or multiple-use and the thickness (4 mil or 6 mil).
25	If treatment is conducted outside, fill in the weather conditions.
26	Fill in the cubic capacity of the enclosure (ft ³).
27	If commodity is treated under APHIS Section 18 Exemption, check "Yes." If commodity is treated at label dosage or less, check "No."
28	Fill in the number of fans used.
29	Fill in the total cubic feet per minute of air movement.
30	Fill in the amount of time the fans are operated.
31	If the commodity is for food or feed, check "Yes." If nonfood or feed, check "No."
32	Record time gas introduction (a) began and (b) ended. Treatment does not begin until gas is completely introduced in the chamber or enclosure.
33	When the fumigant dosage is calculated by weight, fill in the dosage to the nearest quarter pound. If liquid measures are needed, convert from weight to volume by using the conversion table in Appendix C .

Appendix A Forms

PPQ Form 429B, Fumigation Record (Without Tarpaulin)

Table A-1 Instructions for Completing PPQ Form 429A and PPQ Form 429B (continued)

Block	Instruction
34	If additional gas is required, note under Remarks (Block 40) and show calculations (Block 41).
35	Check "Yes" or "No". If needed, see Block 7 on APHIS Form 2061 for the Sample Number.
36	Record the date and time gas concentration readings are taken. Refer to the treatment schedule for required times. Gas concentration readings are not required for chamber treatments.
37	Specify where each gas sampling line is located, either in the space or the commodity. Use a minimum of three gas sampling lines. Methyl Bromide: Record the gas reading directly from the gas analyzer (lbs./1,000 ft ³) Sulfuryl Fluoride: Record the gas reading directly from the gas analyzer (lbs./1,000 ft ³) or apply a correction factor if calibrated using a correction factor. Phosphine: Record the gas reading directly from the gas analyzer or colorimetric tubes (PPM)
38	Fill in the time intervals when gas concentration readings are taken.
39	Fill in PPQ official initials.
40	Fill in colorimetric tube readings (PPM).
41	Show calculations when additional gas is added. Note any unusual events that occurred during the treatment. If the fumigation is aborted record details in this block. For tarpless container fumigations, record the results of the pressure test in this block.
42	Show calculations for determining volume ($L \times W \times H = \text{ft}^3$)
43	Fill in PPQ official signature.
44	Fill in date the fumigation was completed.
45	Fill in the reviewer signature
46	Fill in the date the reviewer signed.

Distribution

File the original paper copies as directed by your supervisor. The original must be retained for 3 years.

PPQ Form 519, Compliance Agreement

According to the Paperwork Reduction Act of 1995, an agency may not conduct or sponsor, and a person is not required to respond to, a collection of information unless it displays a valid OMB control number. The valid OMB control numbers for this information collection are 0579-0054, 0088, 0129, 0198, 0257, 0310, 0317, 0322, 0337, 0346, 0363, and 0369. The time required to complete this information collection is estimated to average 1.25 hours per response, including the time for reviewing instructions, searching existing data sources, gathering and maintaining the data needed, and completing and reviewing the collection of information.		OMB APPROVED 0579-0054/0054/0129/ 0198/0257/0310/0317/ 0322/0337/0346/0363/ 0369
UNITED STATES DEPARTMENT OF AGRICULTURE ANIMAL AND PLANT HEALTH INSPECTION SERVICE PLANT PROTECTION AND QUARANTINE		COMPLIANCE AGREEMENT
1. NAME AND MAILING ADDRESS OF PERSON OR FIRM		2. LOCATION
3. REGULATED ARTICLE S		
4. APPLICABLE FEDERAL QUARANTINE(S) OR REGULATIONS		
5. I / WE AGREE TO THE FOLLOWING:		
6. SIGNATURE	7. TITLE	8. DATE SIGNED
The affixing of the signatures below will validate this agreement which shall remain in effect until canceled, but may be revised as necessary or revoked for noncompliance.		9. AGREEMENT NUMBER
		10. DATE OF AGREEMENT
11. PPQ/CBP OFFICIAL NAME AND TITLE		12. ADDRESS
13. SIGNATURE		
14. U.S. GOVERNMENT/STATE AGENCY OFFICIAL NAME AND TITLE		15. ADDRESS
16. SIGNATURE		
PPQ FORM 519 SEP 2012		All previous editions are obsolete.

Figure A-11 Example of PPQ Form 519, Compliance Agreement

Purpose

The PPQ Form 519 is a form that provides a signed, written agreement with fumigators to indicate their understanding of methods, conditions, and procedures necessary for compliance with regulations.

The [PPQ Form 519](#) is also available electronically.

Instructions

PPQ ports that provide import, domestic, and predeparture treatments are required to maintain Compliance Agreements with commercial pesticide applicators, cold treatment facilities, irradiation facilities, and any other entities performing treatments that mitigate a pest. PPQ may discontinue certification of a particular treatment that did **not** meet the required time, temperature, and concentration levels indicated in the treatment schedule. Similarly, PPQ may **not** want to begin monitoring a fumigation if the tarp appears inadequate and excessive leakage may lead to a safety problem.

Review compliance agreements at least annually, but preferably twice a year. Amend compliance agreements as appropriate.

If the establishment fails to abide by the conditions of the agreement, then the Port Director may cancel that agreement orally or in writing.

If you make an oral cancellation, confirm it in writing as soon as possible. The establishment has 10 days to appeal the cancellation. Appeals **must** be made to the Deputy Administrator.

Table A-2 Instructions for Completing PPQ Form 519, Compliance Agreement

Block	Instruction
1, 8, 9, 10-12	Fill in.
2	Fill in the location of the specific property(s) for which the agreement is signed.
3	Fill in the specific regulated articles to which the agreement applies.
4	Fill in the titles, parts, and subparts.
5	Outline stipulations which apply to the fumigator for each quarantine or regulation affecting the fumigator. Make clear to the fumigator that stipulations in the compliance agreement do not preclude compliance with other sections of the quarantine or regulations. If space in Block 6 is inadequate for listing the stipulations, then write "see Attached Sheets."
6	Have a responsible official of the fumigator's sign.
9	Assign a compliance agreement number.
13	Have the PPQ Port Director sign.
14-16	Complete only when State is involved in cooperating with enforcing Federal quarantines.

Distribution

Table A-3 Distribution of PPQ Form 519, Compliance Agreement

If:	Then:
Compliance agreement affects one work unit	<ol style="list-style-type: none">1. GIVE original to the fumigator, and2. KEEP a copy for port files in the area where the fumigator is located
Compliance agreement affects more than one work unit	<ol style="list-style-type: none">1. GIVE original to the fumigator, and2. GIVE copies to all work units affected by the compliance agreement, and3. KEEP a copy for port files in the area where the fumigator is located

PPQ Form 523, Emergency Action Notification

According to the Paperwork Reduction Act of 1995, no persons are required to respond to a collection of information unless it displays a valid OMB control number. The valid OMB control number for this information is 0579-0102. The time required to complete this information collection is estimated to average 1 hour per response, including the time for reviewing instructions, searching existing data sources, gathering and maintaining the data needed, and completing and reviewing the collection of information.

FORM APPROVED - OMB NO. 0579-0102

U.S. DEPARTMENT OF AGRICULTURE ANIMAL AND PLANT HEALTH INSPECTION SERVICE PLANT PROTECTION AND QUARANTINE EMERGENCY ACTION NOTIFICATION	SERIAL NO. 1. PPQ LOCATION 2. DATE ISSUED 4. LOCATION OF ARTICLES 5. DESTINATION OF ARTICLES 7. NAME OF CARRIER 8. SHIPMENT ID NO.(S) 10. PORT OF LADING 11. DATE OF ARRIVAL 12. ID OF PEST(S), NOXIOUS WEEDS, OR ARTICLE(S) 12a. PEST ID NO. 12b. DATE INTERCEPTED 13. COUNTRY OF ORIGIN 14. GROWER NO. 15. FOREIGN CERTIFICATE NO. 15a. PLACE ISSUED 15b. DATE
3. NAME AND QUANTITY OF ARTICLE(S) 6. SHIPPER 9. OWNER/CONSIGNEE OF ARTICLES Name: _____ Address: _____ _____ _____ PHONE NO. _____ FAX NO. _____ SS NO. _____ TAX ID NO. _____	16. ACTION REQUIRED <input type="checkbox"/> TREATMENT: _____ <input type="checkbox"/> RE-EXPORTATION: _____ <input type="checkbox"/> DESTRUCTION: _____ <input type="checkbox"/> OTHER: _____ Should the owner or owner's agent fail to comply with this order within the time specified below, USDA is authorized to recover from the owner or agent cost of any care, handling, application of remedial measures, disposal, or other action incurred in connection with the remedial action, destruction, or removal.
17. AFTER RECEIPT OF THIS NOTIFICATION COMPLETE SPECIFIED ACTION WITHIN (Specify No. Hours or No. Days):	18. SIGNATURE OF OFFICER: _____ _____ ACKNOWLEDGMENT OF RECEIPT OF EMERGENCY ACTION NOTIFICATION <i>I hereby acknowledge receipt of the foregoing notification.</i> SIGNATURE AND TITLE: _____ DATE AND TIME: _____
19. REVOCATION OF NOTIFICATION ACTION TAKEN: SIGNATURE OF OFFICER: _____ DATE: _____	

PPQ FORM 523 (JULY 2002) Previous editions are obsolete.

Figure A-12 Example of PPQ Form 523, Emergency Action Notification

Purpose

The Emergency Action Notification (EAN) is a document that serves purposes for APHIS regulations. When an emergency action **must** be taken on a consignment, this form allows Customs and Border Protection Agriculture specialists (CBPAS) and/or Plant Protection and Quarantine (PPQ) to communicate the need for a specific action on a consignment to the interested parties. The EAN specifies to the broker, shipper, market owner, or other stakeholder the reason(s) why the consignment is being refused and basic explanation(s) as to what action is necessary.

The document also serves other critical needs. Use of the EAN information assists in determining risks and identifying trends. Through data compilation and analysis PPQ will use the information to update regulations, inform trade partners of areas of concern in foreign countries, and help with domestic emergencies. Targeting is another use for the information. CBPAS will be better able to determine which consignments may need closer inspection.

An EAN **must** be issued from the [Agricultural Risk Management System \(ARM\)](#) every time an emergency action is ordered for an agricultural purpose in the cargo or express courier environment. Agricultural purposes would be those that relate back to a violation of a regulation within the 7 CFR or 9 CFR chapters.

NOTICE

Do not issue the official EAN as a handwritten document, typed on a manual typewriter, from any local database, or any means of issuance other than the ARM.

Issue an EAN when:

- ◆ The Agriculture Specialist finds an actionable pest, potential quarantine pest, a contaminant, or prohibited product
- ◆ The Agriculture Specialist needs to record a commercial seizure
- ◆ The consignment contains non-compliant WPM
- ◆ The consignment is in the express courier environment (i.e. FedEx, UPS, DHL, etc.)
- ◆ The consignment lacks proper documentation

Do **not** issue an EAN for the following reasons:

- ◆ Condition of Entry/Precautionary Treatments—An EAN is **not** to be issued for a consignment requiring treatment as a condition of entry.
- ◆ Holding a Consignment—An EAN is **only** for taking immediate action. Do **not** use an EAN as a hold or supplemental hold for a consignment for any other reason than immediate treatment.

- ◆ Mail—Do **not** issue an EAN for any USPS mail. A Mail Interception Notification (PPQ 287) **must** be used for these consignments.
- ◆ No Inspection—An EAN is **only** to be issued if a consignment has been inspected (either a physical inspection of the goods or a paperwork inspection when that is the requirement) and an agricultural problem has been found. Do **not** write an EAN in lieu of inspection.
- ◆ Other Agencies’ Regulations—EAN's are **not** to be issued for a violation of other agencies regulations. The **only** regulations that may be cited on the EAN are chapters 7 CFR and 9 CFR.
- ◆ Quality Issues—An EAN is **not** to be issued for the quality of a consignment. If the consignment does **not** pose a pest risk, do **not** write an EAN.
- ◆ Selected Animal Products—EAN's are **not** to be issued on consignments of live animals or live animal commodities that are regulated by Veterinary Services. Refer to the *Animal Product Manual* for instructions on these products.

Instructions

The instructions in [Table A-4](#) are for initiating an EAN. The ARM electronic version of PPQ Form 523 is the **only** method by which an official EAN may be issued. **Emergency Action Notifications may not be issued in any other format.** Fields marked with an asterisk (*) are mandatory fields.

Table A-4 Instructions for Initiating an EAN

Block	Field Name	Instructions
1	Issuing Port	Select the port in which the EAN is being issued. Please note that some users will have multiple locations. If the user is assigned to multiple locations, be sure to select the correct location. If the user is not assigned to a port to which he/she requires access, contact the help desk.
2	Date Issued	Enter the date that the EAN was issued.

Table A-4 Instructions for Initiating an EAN (continued)

Block	Field Name	Instructions
3 Name and Quantity of Manifested Article	Article Category* Article Name*	<p>This block is to determine the commodity of the consignment. Only one commodity is allowed to be listed per EAN. Do not list pallets, crates, dunnage, etc., as the Name of Article unless they are the actual commodity being shipped.</p> <p>Article Category–Select a category (Animal Product, Plant Product, or Miscellaneous). The user must select the appropriate category, as the other fields in this block are dependent on it.</p> <p>Animal Products</p> <p>Animal Classification–Select the classification of the consignment. The classification selected will determine the drop down list for the classification category in the next field. See the Animal Products Manual (APM) contents page for further clarification.</p> <p>Classification Category–Select the classification category. The classification category will determine if a classification subcategory is required. To decide on a classification category see the APM classification selected in the previous field.</p> <p>Classification Subcategory–Select the classification subcategory. This information can be found in consignment documentation.</p> <p>*The drop down lists in this category have come directly from the Animal Products Manual. If you need assistance with this menu, see the APM.</p> <p>Plant Products</p> <p>This selection is for fresh cut flowers, fresh fruits and vegetables, logs, lumber, and propagative materials only. Any processed plant products (mulch, handicrafts, potpourri, Chinese teas, etc.) will be found in the Miscellaneous Category.</p> <p>Miscellaneous Products</p> <p>This category is for all products that do not fit into either Animal Products or Plant Products as defined above. Select the category that best fits the commodity. If there is not a category that fits your item, please contact the help desk, National Coordinator, or Regional Coordinators before continuing. If the user selects miscellaneous, a description of the article must be entered. The description should be as accurate as the information available. For example, brake pads, bolt screws, linen fabric, stuffed toys, etc. if the product is agricultural but processed, the user must give an exact description of the article. For example, wooden birdhouses with grass roofs, dried whole apricots, wood carvings with bark edging, etc.</p> <p>Article Name–This drop down list has been determined by the user’s previous selections. If the user does not find the article name in the drop down list please contact the help desk.</p>
	Quantity* Unit of Measure*	<p>Enter the numerical quantity of the consignment. When determining the article quantity, use the most specific number. For example, kilograms is a better selection than box count when dealing with most produce or meat products, but square meter is a better selection for veneer. “Boxes/Crates” may not be used if another option is available.</p>
	APHIS Permit Number	<p>APHIS Permit Number–If the consignment has any kind of APHIS permit, enter the number here.</p>

Table A-4 Instructions for Initiating an EAN (continued)

Block	Field Name	Instructions
3 Name and Quantity of Manifested Article (continued)	Wood Packing Material*	Check the appropriate boxes. If the user selects none or non-compliant, only one box may be selected, but if the wood is non-compliant the user may choose both non-compliant for timber pest and no markings. If wood is not marked with an acceptable symbol, then it is considered unmarked.
4	Location of Articles*	The location of articles is the place where the consignment is located when it is inspected. For example: US Air Warehouse, 123 Airplane Way, Butte, MT 12345. Each port will have a local drop down list so that users will not have to type addresses that have already been added to the system. If using the drop down list, ensure that the correct location has been selected. If the location that the user needs to select is not on the default list, it may be added by port users and supervisors by selecting "Set Defaults." All locations must contain the name of the facility, the physical address, city, state, and zip code.
5 Delivery Address of Articles	Name*	Enter the name of the company/individual accepting the goods as destination of the articles (delivery address). Do not use the broker as destination. Do not automatically assume that the consignee address and delivery address is the same.
	Address where the articles will be delivered*	Enter the address where the goods are intended to be delivered including street address, city, state (within the US), country, and zip/postal code. If the consignment has multiple destinations, the officer should include the destination to which the majority of the consignment is being delivered. If the consignments will be distributed evenly then choose the location to which the product could potentially cause the greatest risk. When determining the address to select, the officer should use his/her best judgment. Additional delivery addresses should be entered into the "Comments" field on page 4 of the data entry screens. Questions regarding this should be directed to the officer's first line supervisor.
6 Shipper	Name*	Enter the name of the shipper.
	Address of Shipper*	Enter the address of the shipper including street address, city, and country. Enter state/province and postal code, if known. This must be a foreign address.
7 Name of Carrier	Name*	Enter the name of the carrier company. For example: Northwest Airlines, M/V Panama, Canadian Pacific, Yellow Freight. On the land borders, independent trucks frequently cross. If the truck is independent, use the name of the owner of the tractor. Do not enter vehicle numbers in this field. Do not enter abbreviations for the name of carrier including airline codes.
	Flight/Voyage Trip Number*	Enter the appropriate number based on pathway. For trucks, use the trailer license number.
8 Consignment Identification Numbers	Airway Bill, Bill of Lading, PAPS Code*	Enter the bill of lading number. If the cargo is border cargo and does not have a bill number, use the PAPS code. This is a mandatory field. Every consignment will have this number at the time that consignment is presented for inspection.
	Tariff Number*	Enter the 10-character tariff number as provided in ACS or ATS. This is indicated in ATS as the HTS number. Do not add any punctuation, numbers only. If the user cannot find the tariff number in ATS or ACS, then refer to the U.S. International Trade Commission Harmonized Tariff Schedule website .

Table A-4 Instructions for Initiating an EAN (continued)

Block	Field Name	Instructions
8 Consignment Identification Numbers (continued)	Customs Entry Number*	Enter the Customs Entry Number. Do not add any punctuation, numbers only. *If the entry has not yet been filed at the time of inspection, enter “Not Yet Filed.” *If the consignment is of low value (under \$2,000 as of 09/2006) it is considered informal and no entry number will ever be processed, enter “Informal.” Do not enter N/A or Not Available. If the user doesn’t have an entry number other than listed above, describe why.
	Container Number	Enter the complete container number. This is usually a 4-letter code followed by 5 or 6 numbers. Include the check digit.
	ISPM Markings	Enter the complete information from the ISPM Marking (IPPC wood marking). If the officer finds a pest in marked wood, this is a required field.
	Other Identifying Number	This field is available to include another number that there is either not a field for or can be used for a number collected for port policy. Examples include invoice number, consignment number, etc. If the pathway is air cargo, the House Airway Bill must be entered here.
	Other Identifying Number Description	If the user enters an “Other Identifying Number” then this field must be completed. The entry should clearly identify what the “Other Identifying Number” is. Do not use abbreviations in the description other than HAWB for “House Airway Bill.”
9 Consignee of Articles	Name*	Enter the name of the Consignee. This will be a company name most of the time. If the consignment owner is an individual, enter the name of the individual. The Consignee is the owner of the consignment. The broker is usually not the consignee.
	Address of Consignee*	Enter the street address of the consignee. Street address, city, and country must be entered. Enter the state/province and postal code, if known.
	Phone and Fax Numbers	Enter the phone and fax numbers of consignee, if known.
10 Port of Lading	City*	Enter the foreign city where the consignment was last loaded onto a vessel, plane, rail car, or vehicle.
	Country*	Enter the foreign country where the consignment was last loaded onto a vessel, plane, rail car, or vehicle.
11	Date of Arrival*	Enter the date that the consignment entered the port.

Table A-4 Instructions for Initiating an EAN (continued)

Block	Field Name	Instructions
12	Reason for EAN*	<p>Select the reason(s) that the EAN is being issued. The following is a guideline to help determine the reason.</p> <p>Pest - If a pest or disease is found on, in, or with a consignment. Do not enter a tentative ID. A national AQAS Pest ID number will be required.</p> <p>Lacks Documentation or Certification - Consignment is missing documentation or the documentation is not acceptable. Documents may include, but are not limited to health certificates, FSIS paperwork, permits, phytosanitary certificates, etc.</p> <p>Contaminant (seed) - Consignment is found to have seed or seed heads that are contaminants, but not part of the manifested commodity. A national AQAS Pest ID number is required.</p> <p>Contaminant (other) - Consignment is found to have any contaminant that does not need to be sent to an identifier. Examples include blood, soil, manure, etc.</p> <p>Lacking ISPM15 Marking - Consignment was found to have unmarked or improperly marked WPM.</p> <p>Prohibited Animal Product - Consignment was found to be prohibited by 9 CFR regulation.</p> <p>Prohibited Product - Consignment was found to be prohibited by 7 CFR regulation.</p>
12a	Pest ID Number*	Enter the Pest ID number generated by the Pest ID system. This number must be provided by the identifier or an APHIS employee acting on behalf of an identifier. If pest or seed contaminant is selected as the reason for the EAN, then the user will have to enter the 17-digit Pest ID number. If the user does not have the Pest ID number, the EAN may be saved and printed; however, the EAN cannot be closed until this information has been added. The system will not accept local pest ID numbers in any form.
12b	Date Intercepted*	Enter the date that the reason for writing the EAN was found. This date must match the date that is entered on the Pest ID record (309A).
13	Country of Origin	Enter country of origin. The country of origin is not necessarily the country from which it is being shipped. The country of origin is the location where the commodity was grown, manufactured, or produced. For example, a consignment of handicrafts might be shipped from Canada, but were made in China. China is the country of origin. Canada is the country of lading.
14	Grower/Facility Number	Enter the number of the foreign facility in which the product was processed, or the foreign grower number. This number is frequently found on the invoice. It may also be available in ATS.
15	Foreign Sanitary Certificate Status*	Select the status of the certificate. If a certificate is not required, continue to Block 16.
15a	Foreign Sanitary Certificate Number	Enter the certificate number.
15b	Place Issued	Enter City/Country where the certificate was issued. This will be a foreign address.
	Date Issued	Enter the date on which the certificate was issued.
Contact Number	Phone Number*	Enter the phone number at which the user issuing the EAN can be reached.

Table A-4 Instructions for Initiating an EAN (continued)



Block	Field Name	Instructions											
16	Treatment Schedule	Using the drop down menu, if treatment is available , select the appropriate treatment schedule. The treatment schedule must be provided by a PPQ Identifier or PPQ employee acting on behalf of an Identifier. CBPAI should not select a treatment schedule that has not been approved by a PPQ Identifier or PPQ employee acting on behalf of an Identifier.											
	Explanation Text*	<p>Select the explanation text that best matches the scenario for this EAN. This explanation tells the acceptor of the EAN two things: 1) what the problem is, and 2) how to correct the situation. This is where the options are given. Do not use the “check boxes” printed on the form.</p> <p>The identifier will verify Federally Recognized State Managed Phytosanitary (FRSMP) Program status and/or FRSMP options. If the pest is a FRSMP Program pest, then movement may be restricted.</p> <table border="1" style="width: 100%; border-collapse: collapse;"> <thead> <tr> <th style="width: 33%;">If the pest is:</th> <th style="width: 33%;">And the commodity is:</th> <th style="width: 33%;">Then:</th> </tr> </thead> <tbody> <tr> <td rowspan="2">A FRSMP Program pest</td> <td>Arriving in a FRSMP Program State for that pest</td> <td> Use one of the following options: ◆ Treat ◆ Export ◆ Destroy ◆ Other If "Other" is selected, then follow requirements to "Re-direct and Avoid" the FRSMP Program State </td> </tr> <tr> <td>Arriving in other than a FRSMP Program State for that pest</td> <td>Use option "Other" and notify the broker/importer of movement restriction to "Avoid" FRSMP Program States.</td> </tr> <tr> <td>Not as above</td> <td style="text-align: center;"></td> <td>No FRSMP action is required.</td> </tr> </tbody> </table>	If the pest is:	And the commodity is:	Then:	A FRSMP Program pest	Arriving in a FRSMP Program State for that pest	Use one of the following options: ◆ Treat ◆ Export ◆ Destroy ◆ Other If "Other" is selected, then follow requirements to "Re-direct and Avoid" the FRSMP Program State	Arriving in other than a FRSMP Program State for that pest	Use option "Other" and notify the broker/importer of movement restriction to "Avoid" FRSMP Program States.	Not as above		No FRSMP action is required.
	If the pest is:	And the commodity is:	Then:										
	A FRSMP Program pest	Arriving in a FRSMP Program State for that pest	Use one of the following options: ◆ Treat ◆ Export ◆ Destroy ◆ Other If "Other" is selected, then follow requirements to "Re-direct and Avoid" the FRSMP Program State										
		Arriving in other than a FRSMP Program State for that pest	Use option "Other" and notify the broker/importer of movement restriction to "Avoid" FRSMP Program States.										
	Not as above		No FRSMP action is required.										
Phyto-Fumigation Disclaimer	If fumigation is an option, the phyto disclaimer must be selected.												
CFR Regulation*	Select the CFR under which the consignment is being regulated. More than one CFR can be selected. To look up a CFR, refer to the Code of Federal Regulations .												
Seal Text	<p>If the consignment must be transferred to another location under seal, select the text that is appropriate to the scenario. If the consignment is being sent for treatment by PPQ, the quantity of the consignment being transferred (preferable in box count) must be included.</p> <p>NOTE: If the PPQ Officer supervising the treatment does not know the quantity to be treated, the consignment will not be treated until that information is provided from CBP.</p>												
Comments	<p>If the user has any additional comments to make, they should be recorded in the Comment field. Do not repeat information that has previously been provided. Do not enter any pest name in this location.</p> <p>It may be helpful on a local level to enter a local ID number or broker information here.</p> <p>NOTE: These comments will print on the paper EAN.</p>												

Table A-4 Instructions for Initiating an EAN (continued)

Block	Field Name	Instructions
17	After Receipt of Notification Complete Specified Action Within:	The user should select the amount of time allowed before treatment begins. For example, if the consignment is to be re-exported then the user should select the amount of time before the consignment must be on the conveyance back to country of origin.
18	Name of Inspecting Officer	Enter the name of the officer who inspected the consignment. Do not enter the name of the person entering the data unless it is the same individual.
Acknowledgment of Receipt of Notification	Name of Recipient	Enter the first and last name of the person accepting the EAN. The user must have this person print their name next to the signature. The only acceptable entry in this field is the first and last name of the person accepting the EAN. Do not enter "On File."
	Title of Recipient	Enter the title of the person accepting and signing the EAN. Preferably enter name of their company as well. Example: Dispatcher, American Shipping.
	Date Signed	Enter the date the EAN was signed and accepted.
19 Revocation Notification	Reason for Action Taken*	Enter the reason that the EAN was written. This should match the data entered in block 12.
19 Revocation Notification (continued)	Action Taken*	Enter the action that was actually taken. Do not enter an action unless that action was taken. If the action was "Treatment," select the treatment type. If the action was "Other," enter what action was taken in the "Additional Remarks" section. Be descriptive in the narrative. If FRSMPO option "Avoid" was selected, then the additional comment should read "Broker/importer has been notified."
	Was the Article Mislabeled, Misrepresented, or Concealed?*	Select yes or no.
	Form 518 Reference Number	If the above answer is yes, then a 518 number must be entered.
	Additional Remarks	If the user has additional information that was not previously recorded, it should be entered here. This field is required if Action Taken-Treatment Type is equal to "Other." This field will not print at any time. These are private comments visible only to system users.
	Signature of Officer*	Enter the name of the officer who completed or monitored the treatment, received confirmation of destruction, or received confirmation of re-exportation. Do not enter the data entry clerk's name unless it is the same officer as described above. This may be a different user than originally opened the EAN.
	Date Action was Completed*	Enter the date that the final action was completed.

(* denotes a mandatory field)

Special Instructions for Infested Vessels Sailing Foreign Without Treatment

When an infested vessel is allowed to sail foreign without treatment, type the following statement in the "Comments" field on the EAN:

“The requirements of the Emergency Action Notification are suspended upon condition that this vessel shall leave the territorial limits of the United States within *[list number]* of hours after receipt of this notice. This vessel shall **not** re-enter any port in the United States unless it has been treated in accordance with the notification and certified by the person who applied the treatment. If the certificate is **not** presented to the CBP officer when arriving at a port in the United States, or if the CBP officer for any other reason is **not** satisfied that the infestation has been eliminated, the notification shall immediately become effective and treatment required.”

Distribution

Because PPQ Form 523 is now electronic, distribution as in the past, on every EAN, is unnecessary. The procedure has been that the signing party, who is responsible for the cargo, receives a hard copy of the notification. The hard copy is necessary to communicate to the consignee or shipper, and also gives the broker time to review the options and select one. The CBP contact number is listed as well.

Routinely sending the EAN to any other parties is not required. Sharing courtesy copies between PPQ and CBP should continue for local, regional, or national projects. Ports may also keep their own hard copies.

PPQ Form 449-R, Temperature Recording Calibration Report

Use the PPQ Form 449-R to document the calibration of temperature sensors for in transit cold treatment in vessels.

TEMPERATURE RECORDING CALIBRATION REPORT (IN-TRANSIT COLD TREATMENT)												1. NAME OF VESSEL Crown Emerald			
2. PPQ DUTY STATION Houston			3. DATE OF INSPECTION 8-5-2008			4. POINT OF INSPECTION Bremerhaven, Germany			5. HULL NUMBER AND DOCKYARD 164-Imabari						
6. IMO NUMBER 9128037			7. FLAG (3-LETTER CODE) PAN			8. SHIP'S OFFICER ENS Smith			9. OWNER/OPERATOR Wallem Management						
10. RECORDING INSTRUMENT 1						11. RECORDING INSTRUMENT 2									
Recorder(s) must match CPHST website – see instructions.															
10a. MAKE Mycorn						11a. MAKE									
10b. MODEL Marcs						11b. MODEL									
TEMPERATURE SENSORS (If unsatisfactory, explain in item 17.)															
12. LOCATIONS MATCH DIAGRAM Satisfactory <input checked="" type="checkbox"/> Unsatisfactory <input type="checkbox"/>			13. LABELING OF SENSORS/BOXES Satisfactory <input checked="" type="checkbox"/> Unsatisfactory <input type="checkbox"/>			14. CABLE LENGTH Satisfactory <input checked="" type="checkbox"/> Unsatisfactory <input type="checkbox"/>			15. REACTION TIME Satisfactory <input checked="" type="checkbox"/> Unsatisfactory <input type="checkbox"/>						
16. TEMPERATURE READINGS AT 0 C (32 F)															
BULB NO.	TEST			BULB NO.	TEST			BULB NO.	TEST			BULB NO.	TEST		
	I	II	III		I	II	III		I	II	III		I	II	III
1A1	0.1	0.1		1C3	0.0	0.0		2A4	0.1	0.1		2C4	0.1	0.1	
1A2	0.0	0.0		1C7	0.0	0.0		2A5	0.1	0.1		2C5	0.1	0.1	
1A3	0.1	0.1		1C8	0.0	0.1		2A6	0.1	0.1		2D1	0.1	0.1	
1A4	0.1	0.1		1C9	0.0	0.0	0.0	2A7	0.1	0.1		2D2	0.1	0.1	
1A5	0.1	0.1		1D1	0.1	0.1		2B3	0.1	0.1		2D3	0.1	0.1	
1A6	0.1	0.1		1D2	0.1	0.1		2B8	0.1	0.1		2D4	0.1	0.1	
1A7	0.1	0.1		1D3	0.1	0.1		2B9	0.1	0.1		2D5	0.1	0.1	
1B1	0.1	0.1		1D4	0.1	0.1		2B10	0.1	0.1		3A1	0.1	0.1	
1B2	0.1	0.1		1D5	-0.2	-0.2		2B11	0.1	0.1		3A2	0.1	0.1	
1B4	0.2	0.2		1D6	-0.1	-0.1		2C1	0.1	0.1		3A3	0.1	0.1	
1B5	0.0	0.0		2A1	0.2	0.2		2C2	0.1	0.1		3A4	0.1	0.1	
1B6	0.0	0.0		2A2	0.3	0.3		2C3	0.1	0.1		3A5	-0.1	-0.1	
17. REMARKS (List names of all USDA officials participating in the calibration.) D. Jones, S. Wood															
18. COMPANY NAME AND ADDRESS TO SEND CERTIFICATE OF APPROVAL Wallem Ship Management, 1799 West Street, New York, NY												19. COMPANY EMAIL WSM@gmail.com			
21. SIGNATURE OF LEAD INSPECTOR												20. COMPANY PHONE NUMBER 800-879-4659			
												22. DATE 5-August-2008			

PPQ FORM 449-R (Local Reproduction Authorized) (SEPT 2008)

Figure A-13 Example of PPQ Form 449-R, Temperature Recording Calibration Report

Instructions for Completing PPQ Form 449-R

Table A-5 Instructions for Completing PPQ Form 449-R

Block	Instructions
1	Verify that the vessel name agrees with the name on the S&T-TMT intransit cold treatment website .
2	PPQ Officer's duty station
3	Date of inspection
4	Place of inspection
5	Verify that the hull number and dockyard agrees with the S&T-TMT intransit cold treatment website .
6	The IMO number is a unique identification number for every vessel engaged in commerce and provides a complete history of the vessel. Verify that the IMO number agrees with the S&T-TMT intransit cold treatment website . If this information is not on the S&T-TMT website, collect the number from the ship's officer and record in this block.
7	Verify that the flag (country of registry) agrees with the 3-letter code on the S&T-TMT intransit cold treatment website .
8	Name of Captain, Chief Engineer, Reefer Engineer, or First Officer
9	Name of the shipping line owner or agent. Verify with S&T-TMT intransit cold treatment website .
10a, b	Verify the make and model agree with the information on the website. If the information differs from that listed on the website, gather as much information as possible from the vessel's crew regarding when (date) instrument was changed, and whether or not they have any documentation from S&T-TMT approving the changes. Record this additional information in the remarks section.
11a, b	Multiple recorders may be used. Record the make and model.
12	Verify that the sensor and cable locations match the diagram on the S&T-TMT website.
13	Verify that the sensors and cables are labeled correctly and in accordance with the sensor diagram.
14	Confirm that air sensors are capable of reaching the floor and fruit sensors are capable of reaching all areas of the compartment from their location along the walls (each should reach past the center line of the compartment).
15	Do the sensors respond appropriately when hand-warmed?
16	TEST ALL AIR AND PULP SENSORS. If officer suspects a compartment to be a hanging deck, test any sensors located in the space and make a notation in this block and in the narrative.
17	Record names of all USDA officials participating in the inspection, indicating lead officer for the report. Include any other information deemed appropriate.
18	Include as much information as possible.
19	Company email.
20	Company phone number.
21	Signature of Lead Inspector.
22	Date the report is completed.

PPQ Form 203, Foreign Site Certificate of Inspection and/or Treatment

<small>According to the Paperwork Reduction Act of 1995, no persons are required to respond to a collection of information unless it displays a valid OMB control number. The valid OMB control numbers for this information collection are 0579-0190 and 0173. The time required to complete this information collection is estimated to average .5 hours per response, including the time for reviewing instructions, searching existing data sources, gathering and maintaining the data needed, and completing and reviewing the collection of information.</small>		<small>OMB APPROVED 0579-0190 and 0173</small>	
U.S DEPARTMENT OF AGRICULTURE ANIMAL AND PLANT HEALTH INSPECTION SERVICE PLANT PROTECTION AND QUARANTINE FOREIGN SITE CERTIFICATE OF INSPECTION AND/OR TREATMENT		1. CERTIFICATE NO.	2. COUNTRY OF ORIGIN
		3. DATE LOADED	4. FOREIGN PORT OF EXPORT
5. CARRIER IDENTIFICATION		6. U.S. PORT OF ENTRY	
7. SHIPPER (Name and Address - Include Zip Code)		8. CONSIGNEE (Name and Address - Include Zip Code)	
9. COMMODITY	10. NO. CONTAINERS (Identify as box, sack, 1/2 Bruce box, flat, cardboard box, etc.)	11. CONTAINER IDENTIFICATION MARKS	
12. LOCATION OF INSPECTION AND/OR TREATMENT		13. DATE	
This certifies that the shipment described above has been inspected and/or treated in accordance with agricultural requirements for entry into the United States.			
14. SIGNATURE OF PLANT PROTECTION AND QUARANTINE OFFICER		15. DATE ISSUED	
PPQ FORM 203 (JUL 2007)			

Figure A-14 Example of PPQ Form 203, Foreign Site Certificate of Inspection and/or Treatment

Purpose

PPQ Form 203 verifies that PPQ has precleared the commodity it accompanies (either through inspection or treatment) at the foreign site.

An electronic copy of this form is available in the [APHIS-PPQ forms library](#).

Instructions

The Agriculture Specialist at Port of Entry (POE) examines this form when a precleared commodity arrives at the port.

The APHIS officer completes this form at the foreign site where the commodity is inspected or treated. The form may either be handwritten in ink or typed. Use [Table A-6](#) to decide what paperwork should be presented upon the arrival of a precleared commodity.

Table A-6 Determine Paperwork to Be Presented upon Arrival of a Precleared Commodity

If arriving from:	And by:	Then the exporter or the exporter's agent must provide the following paperwork:
Australia, Japan, Korea, or the Republic of South Africa	→	<ul style="list-style-type: none"> ◆ Original (yellow or white) PPQ Form 203 for the commodity ◆ Copy of the master PPQ Form 203 or original Phytosanitary Certificate, specifying the number of units shipped or remaining in cold storage from the master PPQ Form 203
Chile	Vessel	<ul style="list-style-type: none"> ◆ Original Chilean Phytosanitary Certificate ◆ E-mail notification of the cargo on board and its status from the IS Region II office to the POE <p style="text-align: center;">NOTE: No PPQ Form 203 will accompany the commodity</p>
	Air	<ul style="list-style-type: none"> ◆ Original (yellow or white) PPQ Form 203 for the commodity ◆ Original Chilean Phytosanitary Certificate
India or Thailand	→	<ul style="list-style-type: none"> ◆ Original (yellow or white) PPQ Form 203 for the commodity ◆ Original Indian or Thailand Phytosanitary Certificate
New Zealand	→	<ul style="list-style-type: none"> ◆ Original PPQ Form 203 for the commodity, or a copy of the master 203 ◆ If a master PPQ Form 203 is submitted, it must be accompanied by an original "Details of Loading Certificate", which is a New Zealand Ministry of Agriculture form specifying the number of units shipped or remaining in cold storage from the master PPQ Form 203.
Other than a country listed in the cells above	→	<ul style="list-style-type: none"> ◆ Original (yellow or white) PPQ Form 203 for the commodity

Verify that any seals listed on the form are still intact. Also, confirm that the information and conditions described on the form agree with the cargo manifest, invoice, or any other CBP entry documents. Contact QPAS at 301-851-2312 if any of the following occurs:

- ◆ Information on the PPQ Form 203 does not match the entry documents

- ◆ PPQ Form 203 is missing
- ◆ Seals are broken

NOTICE

Refer to the [Agricultural Commodity Import Requirements \(ACIR\)](#) database for the commodity being shipped. The commodity may be undergoing in-transit cold treatment. If it is, you need to ensure that the commodity meets the time and temperature requirements.

Instructions for Issuing Officer

The APHIS Issuing Officer will complete PPQ Form 203, as follows:

1. Type the form or write in ink.
2. Number the certificate using the numbering system assigned by the Area Office with responsibility for the program.
3. If the commodity was treated, mark the form with the plant’s approved stamp.
4. Fill in the remaining, self-explanatory information.

Distribution

Issuing Officer

The APHIS Issuing Officer will distribute PPQ Form 203 using [Table A-7](#) as a guide.

Table A-7 Distribution of PPQ Form 203, Foreign Site Certificate of Inspection and/or Treatment

If:	Then:
Original and first copy	GIVE to the exporter (the original must be presented at the first POE)
Copy	SEND to the Area Office, IS, with responsibility for the program
Copy	RETAIN by the certifying APHIS officer
Copy (through the office of cooperator) ¹	FAX a copy to the U.S. Port of Arrival
Copy	ATTACH to trip report

1 This does **not** apply to all programs. Check the technical packet or with the IS Field Office in Charge.

PPQ Form 556, In Transit Cold Treatment Clearance Report

U. S. DEPARTMENT OF AGRICULTURE Animal and Plant Health Inspection Service Plant Protection and Quarantine Programs IN TRANSIT COLD TREATMENT CLEARANCE REPORT		1. NAME OF CARRIER	2. PORT OF LOADING	3. PAGE NO. of										
INSTRUCTIONS: Refer to PPQ Treatment Manual Sec. III part 10 and CFR 319.56-2d.		4. PORT REPORTING	5. DATE	6. TIME										
		7. PORT REPORTING	8. DATE	9. TIME										
10. CONTENTS OF COMPARTMENTS														
COMMODITY	NO. CASES	COMMODITY	NO. CASES	COMMODITY	NO. CASES									
Apples		Nectarines		Pears										
Cherries		Oranges		OTHER (Specify)										
Grapes		Peaches		OTHER (Specify)										
INSTRUMENT EXAMINATION			INSTRUMENT EXAMINATION											
11. INSTRUMENT NO.		12. WAS INSTRUMENT LOCKED? YES <input type="checkbox"/> NO <input type="checkbox"/>		17. INSTRUMENT NO.										
13. PRINTING INTERVAL		14. CHART SPEED (in. or cm/24 hours)		18. WAS INSTRUMENT LOCKED? YES <input type="checkbox"/> NO <input type="checkbox"/>										
15. ACTUAL LENGTH OF RECORD		16. CALCULATED LENGTH OF RECORD		19. PRINTING INTERVAL										
20. CHART SPEED (in. or cm/24 hours)		21. ACTUAL LENGTH OF RECORD		22. CALCULATED LENGTH OF RECORD										
23. CALIBRATION RECORD SATISFACTORY <input type="checkbox"/>		IF NOT SATISFACTORY - WHY		SIGNED BY										
TEMPERATURE RECORD														
24. IDENTIFY COMPARTMENTS														
25. Initial fruit temp. recorded		MAX.	MIN.	MAX.	MIN.	MAX.	MIN.	MAX.	MIN.	MAX.	MIN.	MAX.	MIN.	
26. Loading completed		DATE	TIME	DATE	TIME	DATE	TIME	DATE	TIME	DATE	TIME	DATE	TIME	
27. TREATMENT COMMENCED	2.2°C (36°F)													
	1.7°C (35°F)													
	1.1°C (34°F)													
	0.6°F (33°F)													
	0°C (32°F)													
28. Total No. days treatment to time of clearance		TEMP.	DAYS	TEMP.	DAYS	TEMP.	DAYS	TEMP.	DAYS	TEMP.	DAYS	TEMP.	DAYS	
29. Pulp temperatures (manual check by PPQ officer)		MAX.	MIN.	MAX.	MIN.	MAX.	MIN.	MAX.	MIN.	MAX.	MIN.	MAX.	MIN.	
30. Recorded temperatures		BULB NO.	TEMP.	BULB NO.	TEMP.	BULB NO.	TEMP.	BULB NO.	TEMP.	BULB NO.	TEMP.	BULB NO.	TEMP.	
31. CARGO STORAGE SATISFACTORY <input type="checkbox"/>		IF NOT, SPECIFY WHY						32. SIGNATURE OF OFFICER						
PPQ FORM 556 AUG. 1977		REPLACES PPQ FORM 556(9/74) WHICH MAY BE USED												

Figure A-15 Example of PPQ Form 556, In Transit Cold Treatment Clearance Report

Worksite Specific Respiratory Protection Plan—Template

A worksite specific respiratory protection plan is mandatory. Refer to [Figure A-16](#) through [Figure A-23](#) for a generic template. Authorized users can also refer to the [Safety and Health Sharepoint site](#) for other worksite plans. Contact your FO Safety Manager for a site specific plan.

MANDATORY WORKSITE SPECIFIC RESPIRATORY PROTECTION PLAN

TEMPLATE

APHIS /PPQ FIELD OPERATIONS

RESPIRATORY PROTECTION PROGRAM

COMPLIANCE WITH THIS PUBLICATION IS MANDATORY

This operation instruction (OI) contains information and guidance for proper respirator selection, use, care and maintenance. Template meets OSHA 29 CFR 190.134 Respiratory Protection requirements to establish worksite specific plan.

DIRECTIONS:

- 1.1. Review Policy
- 1.2. Input your Program management position in accordance with identified *font in black*.
- 1.3. May edit or add specific procedures with approval of PPQ FO Safety and Health.

DOCUMENT APPROVAL:

- 1.4. Approval by Local Manager with signature/date
- 1.5. Approval by State Plant Health Director with signature/date
- 1.6. Approval by PPQ FO Safety Manager with signature/date

RECORDKEEPING:

- 1.7. Approved/signed copy (PDF file) of original must be sent to PPQ FO Safety Health Office.
- 1.8. Copy will be kept on Site, readily available for review.

- <http://sp.we.aphis.gov/PPQ/fieldops/safehealth/SitePages/Respiratory%20Protection.aspx>

Figure A-16 Worksite Specific Respiratory Protection Plan—Template (page 1 of 8)

**TEMPLATE FOR SITE USE
 RESPIRATORY PROTECTION PROGRAM
 COMPLIANCE WITH THIS PUBLICATION IS MANDATORY**

Approved By: **NAME OF SPHD**

This operation instruction (OI) contains information and guidance for proper respirator selection, use, care and maintenance.

REFERENCES:

[29 CFR 1910.134, Respiratory Protection](#)

[USDA APHIS Safety and Health Manual, Chap 11](#)

GENERAL:

The use of respiratory protection should be a last resort. Substituting less hazardous materials or processes, eliminating hazards through engineering changes or controls, isolating hazardous operations, or providing administrative controls shall be considered before the decision is made to protect workers with respirators.

No personnel may wear a respirator unless required or recommended by Site Supervisor in conjunction with advice from Safety and Occupational Health Manager/Specialist.

CATEGORIES OF RESPIRATOR USAGE: Site Supervisor shall identify the location and use of all respirators worn by employees.

Operation/Process	Type of Respirator	Cartridge		Category of Use
		Type	Change out Frequency	
<i>Fumigation Process Methyl Bromide Readings > 5ppm</i>	<i>Full Face (SCBA)</i>	<i>n/a</i>	<i>n/a</i>	<i>Required</i>
<i>Fumigation Process Methyl bromide Reading >1- <=4 ppm</i>	<i>APR (Half Face) or APR (Full Face)</i>	<i>Organic Vapor/Acid Gas/P100 cartridges</i>	<i>-Change immediately after each use or if air is restricted when breathing</i>	<i>Required</i>

Medical Clearance: Medical evaluation and clearance is required before performing tasks requiring use of respirators in order to determine an employee is physically able to do the work and utilize the equipment medically (ref. APHIS Safety and Health Manual, Chap 11, Sec 11.3.4, Para F) or (new ref. APHIS Safety and Health Manual, Chap 7, Section 9, Dec. 2010). The evaluation must be performed by a physician or

Figure A-17 Worksite Specific Respiratory Protection Plan—Template (page 2 of 8)

licensed health care professional. Final evaluation approval shall be determined by an authorized APHIS medical provider. The respirator user's medical status should be reviewed every year or as certifying physician determines. The medical evaluation should include, as a minimum, an evaluation to identify pulmonary and cardiovascular impairment.

Training: All personnel will receive initial respiratory protection training prior to wearing a respirator. Periodic training will be accomplished by a work place supervisor annually. Documentation of the initial and annual training will be documented on SF form 182 or equivalent. A copy of the training plan is located in attachment 2.

Fit-Testing: After instruction, a quantitative fit-testing will be conducted. Contact Candace Robl for assistance at (941) 359-3281. Fit Test documentation will be recorded and maintained by Site Supervisor. Employees are only allowed to wear respirators for which they have been fit tested/trained. A respirator fit-test shall be carried out for each wearer of a tight-fitting respirator at least once every 12 months. A new fit test will be accomplished when a worker experiences a change in physical condition that could affect respirator fit (e.g., weight change of more than 20 pounds, facial scarring, dental changes cosmetic surgery, disfigurement, ... etc.).

Program Compliance:

Site Supervisor: Supervisors will be familiar with the training/fit-testing status of all respirator wearers. SF form 182 or computerized equivalent and 429 data base shall be used to record and track the date of the most current certification. Supervisors will ensure personnel on the respirator protection program wear the correct respiratory protection for which they have been fit-tested and trained prior to utilization.

Individuals: Individuals provided respiratory protection will use it according to the instructions and training received. Report to their supervisor any change in medical status, which may impact their ability to safely wear respiratory protection. Inspect, clean, and maintain any respiratory protection device issued to them for their individual use. Wear only respiratory protection (mfg, make, model and size) for which they have received fit-testing and training, and only for the tasks specified.

User Seal Check Procedures:

Workers who use tight-fitting respirators will perform positive and negative pressure checks to ensure adequate seal is achieved each time the respirator is put on.

Positive Pressure Check: Close off exhalation valve and exhale gently into the face piece. The face fit is considered satisfactory if a slight positive pressure can be built up inside the face piece without any evidence of outward leakage of air at the seal. For most respirators this method of leak testing requires the wearer to first remove the exhalation valve cover before closing off the exhalation valve and then carefully replacing it after the test.

Negative Pressure Check: Close off inlet opening of the canister or cartridge(s) by covering with palm of the hand(s) or by replacing the filter seal(s), inhale gently so that the face piece collapses slightly, and hold breath for ten seconds. The design of the inlet opening of some cartridges cannot be effectively covered with the palm of the hand; in those circumstances, covering the inlet opening of the cartridge with a thin latex or nitrile glove can perform this test. If face piece remains in its slightly collapsed condition and no inward leakage of air is detected, tightness of the respirator is considered satisfactory.

Respirator Sealing Problems:

A head covering which passes between the sealing surface of a tight-fitting respirator face piece and the wearer's face shall not be used.

Figure A-18 Worksite Specific Respiratory Protection Plan—Template (page 3 of 8)

Wearing of protective equipment used by the wearer shall not interfere with seal of the respirator. Personnel who are not clean-shaven or on a shaving waiver will not be permitted to wear a tight fitting respirator. If personnel are on a shaving waiver they are disqualified from the tight fitting respirator program until they can shave again.

Vision:

When a respirator user must wear corrective lenses, the wearer must use protective spectacles, goggles, face shields or other eye and face protective devices such that the item shall be fitted to provide good vision and shall be worn in such a manner as not to interfere with the proper seal of the respirator.

Spectacles with straps or temple bars that pass through the sealing surface of either negative or positive pressure, tight-fitting, full-face piece respirators shall not be used.

Contact lenses will not be worn with respirators in a fuel systems repair area.

If an individual who must wear corrective lenses uses spectacle inserts with a full-face piece respirator, then the government will purchase the spectacle inserts for the respirator, using a prescription provided by the user.

Care, Inspection, and Maintenance of Respirators:

General Discussion: Each individual issued a respirator is responsible for its primary maintenance and care. **Supplied Air shall be of high purity and tested according to 29 CFR 1910.134(i)(1)(ii) . Copy of results of breathing air shall be received from vendor and kept by supervisor or designated Respiratory Program Manager.**

Care:

Cleaning and sanitizing: Respirators issued to an individual shall be cleaned and sanitized at the end of each day in which the respirator is used. Each respirator shall be cleaned and sanitized with MSA Cleaner Sanitizer II before and after each use. (See Attachment 1)

Storage: Respirators shall be stored in a manner that will protect them against chemical agents and physical agents such as vibration, shock, sunlight, heat, extreme cold, excessive moisture, or damaging chemicals. Respirators shall be stored to prevent distortion of rubber or other elastomeric parts. Respirators shall not be stored in such places as lockers and toolboxes unless they are protected from contamination, distortion, and damage.

Inspection: The user shall inspect the respirator immediately before each use to ensure it is in proper working condition. After cleaning and sanitizing, each respirator shall be inspected to determine if it is in proper working condition, needs replacement of parts, needs repairs, or should be discarded. Air supplied respirators will be inspected each month. Respirators, which do not meet applicable inspection criteria, shall be immediately removed from service. Respirator inspection shall include a check for tightness of connections; for the condition of the respiratory inlet covering, head harness, valves, connecting tubes, harness assemblies, hoses, filters, cartridges and for the proper functioning of regulators, alarms, and other warning systems. Each rubber or other elastomeric part shall be inspected for pliability and signs of deterioration. The breathing air system shall be inspected to ensure it is fully charged prior to use according to the manufacturer's instructions.

Maintenance:

Only personnel trained in proper respirator maintenance and assembly shall do replacement of parts or repairs.

Figure A-19 Worksite Specific Respiratory Protection Plan—Template (page 4 of 8)

Replacement parts shall be used only as designated for specific respirators.

Respiratory Documentation and Respirator Recordkeeping:

Site Supervisor establish and retain written information regarding medical evaluation, fit testing, respirator training. Itemized PPE maintenance/care/cleaning and appropriate respirator cartridge/filter change-out schedule shall be documented and retained. The documentation shall include User/respirator model/cartridge type/change-out date/cleaning date/initials shall be readily available. The respirator itself shall have a change-out date incorporated on the outside of each cartridge/filter which matches the latest documentation entry.

Print Name / signature

POSITION or RESPONSIBLE SUPERVISOR

Attachments:

1. Respirator Cleaning Procedures
2. Respiratory Protection Shop Specific Training
3. Voluntary use of Respirator-Where Respirators are Not Required

Approved/Disapproved

Signature _____ Date _____

Local Director/Manager

Signature _____ Date _____

State Plant Health Director

Signature _____ Date _____

Safety and Health Office

Figure A-20 Worksite Specific Respiratory Protection Plan—Template (page 5 of 8)

Attachment 1

RESPIRATOR CLEANING PROCEDURES

The following procedure is recommended for cleaning and disinfecting respirators:

1. Remove any filters, cartridges, canisters, or communication devices.
2. Wash face piece and breathing tube in a cleaner-disinfectant solution. Use a soft brush to facilitate dirt removal.
3. Use MSA Cleaner Sanitizer II for proper sanitizing of respirators.
4. Rinse completely in clean, warm, water, which is less than or equal to 120 degrees F.
5. Air-dry in a clean area.
6. Clean other respirator parts as recommended by the manufacturer.
7. Inspect valves, head straps, and other parts; replace defective parts with new ones.
8. Insert new filters, cartridges, or canisters periodically as specified by the manufacturer; make sure seal is tight.
9. Place in plastic bag or other closed container for storage.
10. Document cleaning date, respirator model and user for recordkeeping.

Figure A-21 Worksite Specific Respiratory Protection Plan—Template (page 6 of 8)

Attachment 2

SHOP SPECIFIC TRAINING LESSON PLAN

Respirator Requirement (Type and number of RP must be the same. Change to update for local work unit)

This work center has a requirement for the use of XX different respirators.

List required respirators.

Why is a respirator required?

IAW USDA, PPQ Treatment Manual dated 1 Mar 2006 respirators are required when using various fumigants during the following processes: Installing the exhaust system, opening the tarp for aeration, removing the tarpaulin if measured levels of fumigant are above 5 ppm and any time during the aeration process when a risk of exposure to concentration above 5 ppm exists. **This includes any time the concentration is unknown.**

Confined space incinerator inspection maintenance, cleaning and inspection of propagated material shall require respirator use from possible unknown residual chemical exposure.

What are the potential acute and chronic health effects of exposure to the following material(s)?:

Headache, fatigue, skin irritation, loss of appetite, experience shortness of breath, dizziness, unconsciousness, central nervous system depression, fever and death.

Weight of Respirators:

List weight of required respirators.

List Duration of Use.

List Frequency of Use.

List Expected Physical Work Effort.

List Additional Required PPE.

List Temperature/Humidity Extremes.

Administrative Controls.

Figure A-22 Worksite Specific Respiratory Protection Plan—Template (page 7 of 8)

Attachment 3

Voluntary use of Respirator-Where Respirators are Not Required

APHIS may provide respirators at the request of employees if the Agency determines the respirator will not in itself create a hazard. APHIS has determined disposable respirators will not be used when performing PPQ plant inspection and incinerator duties. Disposable respirators do not protect against possible contamination of pesticides. Disposable respirators will only protect against particulates at a given efficiency rate and size. At a minimum, half face and or full face APR respirators with combination VOC/HEPA cartridge shall be used when suspect possible unknown contaminants.

TEMPLATE

Figure A-23 Worksite Specific Respiratory Protection Plan—Template (page 8 of 8)

Appendix A Forms

Worksite Specific Respiratory Protection Plan—Template

Appendix B

Coast Guard Regulations

This Appendix contains information reprinted from 46CFR, October 1, 2011

Title 46—Shipping

Chapter 1—Coast Guard, Dept. of Transportation

Part 147A—Interim Regulations for Shipboard Fumigation

MINIMUM REQUIREMENTS

General

Sec. 147A.1 Purpose.

Sec. 147A.3 Applicability.

Sec. 147A.5 General requirement.

Sec. 147A.6 Right of Appeal.

Sec. 147A.7 Definitions.

Sec. 147A.9 Persons in charge of fumigation and the vessel; designation.

Sec. 147A.10 Notice to Captain of the Port.

Before Fumigation

Sec. 147A.11 Person in charge of fumigation; before fumigation.

Sec. 147A.13 Person in charge of the vessel, before fumigation.

During Fumigation

Sec. 147A.21 Person in charge of fumigation; during fumigation.

Sec. 147A.23 Person in charge of vessel; during fumigation.

Sec. 147A.25 Entry.

After Ventilation

Sec. 147A.31 Removal of fumigation material and warning signs.

SPECIAL REQUIREMENTS FOR FLAMMABLE FUMIGANTS

Sec. 147A.41 Person in charge of fumigation; flammable fumigants.

Sec. 147A.43 Other sources of ignition; flammable fumigants.

Authority: 46U.S.C. 5103; Department of Homeland Security Delegation, No. 0170.1.

Source: CGD 74-144, 39 FR 32998, Sept. 13, 1974, unless otherwise noted.

General

Sec. 147A.1 Purpose.

The purpose of this part is to prescribe the requirements for shipboard fumigation that are critical for the health and safety of the crew and any other person who is on board a vessel during fumigation. These are interim rules pending further study and promulgation of comprehensive regulations on shipboard fumigation.

Sec. 147A.3 Applicability.

This part prescribes the rules for shipboard fumigation on vessels to which 49 CFR parts 171-179 apply under 49 CFR 176.5.

Sec. 147A.5 General requirement.

No person may cause or authorize shipboard fumigation contrary to the rules in this part.

Sec. 147A.6 Right of Appeal.

Any person directly affected by a decision or action taken under this part, by or on behalf of the Coast Guard, may appeal therefrom in accordance with subpart 1.03 of this chapter.

Sec. 147A.7 Definitions.

As used in this part:

(a) Qualified person means a person who has experience with the particular fumigant or knowledge of its properties and is familiar with fumigant detection equipment and procedures, or an applicator who is certified by the Environmental Protection Agency if his certification covers the fumigant that is used.

(b) Fumigant means a substance or mixture of substances that is a gas or is rapidly or progressively transformed to the gaseous state though some nongaseous or particulate matter may remain in the space that is fumigated.

(c) Fumigation means the application of a fumigant on board a vessel to a specific treatment space.

Sec. 147A.9 Persons in charge of fumigation and the vessel; designation.

(a) The person, including any individual, firm, association, partnership, or corporation, that is conducting a fumigation operation shall designate a person in charge of fumigation for each operation.

(b) The operator of each vessel shall designate a person in charge of the vessel for each fumigation operation.

Sec. 147A.10 Notice to Captain of the Port.

Unless otherwise authorized by the Captain of the Port, at least 24 hours before fumigation the operator of the vessel shall notify the Coast Guard Captain of the Port for the area where the vessel is to be fumigated, of the time and place of the fumigation, and the name of the vessel that is to be fumigated.

Before Fumigation

Sec. 147A.11 Person in charge of fumigation; before fumigation.

(a) The person in charge of fumigation shall notify the person in charge of the vessel of:

- (1) The space that is to be fumigated;
- (2) The name, address, and emergency telephone number of the fumigation company;
- (3) The dates and times of fumigation;
- (4) The characteristics of the fumigant;
- (5) The spaces that are determined to be safe for occupancy paragraph (b)(1)(i) of this section;
- (6) The maximum allowable concentration of fumigant in spaces, if any, that are determined to be safe for occupancy under paragraph (b)(1)(i) of this section;
- (7) The symptoms of exposure to the fumigant; and
- (8) Emergency first aid treatment for exposure to the fumigant.

(b) The person in charge of fumigation shall ensure that:

(1) A marine chemist or other qualified person who has knowledge of and experience in shipboard fumigation evaluates the vessel's construction and configuration and determines:

- (i) Which spaces, if any, are safe for occupancy during fumigation; and

- (ii) The intervals that inspections **must** be made under Sec. 147A.21(a)(1);
- (2) **No** persons or domestic animals are in the space that is to be fumigated or the spaces that are designated as unsafe for occupancy under paragraph (b)(1)(i) of this section;
- (3) There is proper and secure sealing to confine the fumigant to the space that is to be fumigated, including blanking off and sealing any ventilation ducts and smoke detectors;
- (4) The personal protection and fumigation detection equipment for the fumigant that is to be used is on board the vessel;
- (5) Warning signs are:
 - (i) Posted upon all gangplanks, ladders, and other points of access to the vessel;
 - (ii) Posted on all entrances to the spaces that are designated as unsafe for occupancy under paragraph (b)(1)(i) of this section; and
 - (iii) In accordance with 49 CFR 173.9(c) or section 8.10 of the General Introduction of the International Maritime Dangerous Goods Code. The word “unit” on the warning sign may be replaced with “vessel,” “barge,” “hold,” or “space,” as appropriate.
- (6) Watchmen are stationed at all entrances to:
 - (i) Spaces that are **not** determined to be safe for occupancy under paragraph (b)(1)(i) of this section; or
 - (ii) The vessel, if **no** spaces are determined to be safe for occupancy under paragraph (b)(1)(i) of this section.

Sec. 147A.13 Person in charge of the vessel, before fumigation.

- (a) After notice under Sec. 147A.11(a)(5), the person in charge of the vessel shall notify the crew and all other persons on board the vessel who are **not** participating in the fumigation of the spaces that are determined to be safe for occupancy under Sec. 147A.11(b)(1)(i).
- (b) If **no** spaces are determined to be safe for occupancy under Sec. 147A.11(b)(1)(i), the person in charge of the vessel shall ensure that the crew and all persons who are **not** participating in the fumigation leave the vessel and remain away during fumigation.

During Fumigation

Sec. 147A.21 Person in charge of fumigation; during fumigation.

(a) Until ventilation begins, or until the vessel leaves port, the person in charge of fumigation shall ensure that a qualified person inspects the vessel as follows:

(1) He **must** use detection equipment for the fumigant that is used to ensure that the fumigant is confined to:

(i) The space that is fumigated, if partial occupancy is allowed under Sec. 147A.11(b)(1)(i).

(ii) The vessel, if **no** space is determined to be safe for occupancy under Sec. 147A.11(b)(1)(i).

(2) He **must** make inspections at the intervals that are determined to be necessary by the marine chemist or qualified person under Sec. 147A.11(b)(1)(i).

(b) If leakage occurs, the person in charge of fumigation shall:

(1) Notify the person in charge of the vessel that there is leakage;

(2) Ensure that all necessary measures are taken for the health and safety of any person; and

(3) Notify the person in charge of the vessel when there is **no** danger to the health and safety of any person.

(c) After the exposure period, if the vessel is in port, the person in charge of fumigation shall ensure that fumigators or other qualified persons ventilate the space that is fumigated as follows:

(1) Hatch covers and vent seals **must** be removed, other routes of access to the atmosphere **must** be opened, and if necessary, mechanical ventilation **must** be used.

(2) Personal protection equipment that is appropriate for the fumigant that is used **must** be worn.

(d) If ventilation is completed before the vessel leaves port, the person in charge of fumigation shall:

- (1) Ensure that a qualified person, who is wearing the personal protection equipment for the fumigant that is used if remote detection equipment is **not** used, tests the space that is fumigated and determines if there is any danger to the health and safety of any person, including a danger from fumigant that may be retained in bagged, baled, or other absorbent cargo;
- (2) Notify the person in charge of the vessel of this determination; and
- (3) If it is determined that there is a danger:
 - (i) Ensure that all measures are taken that are necessary for the health and safety of all persons; and
 - (ii) Notify the person in charge of the vessel when there is **no** danger to the health and safety of any person.

Sec. 147A.23 Person in charge of vessel; during fumigation.

- (a) The person in charge of the vessel shall ensure that the crew and all other persons on board the vessel who are **not** participating in the fumigation restrict their movement during fumigation to the spaces that are determined to be safe for occupancy under Sec. 147A.11(b)(1)(i).
- (b) The person in charge of the vessel shall ensure that the crew and all other persons who are **not** participating in the fumigation follow any instructions of the person in charge of fumigation that are issued under Sec. 147A.21(b)(2) or (d)(3)(i) and that the vessel does **not** leave port if he is notified under:
 - (1) Section 147A.21(b)(1) that there is leakage, unless the person in charge of fumigation notifies him under Sec. 147A.21(b)(3) of this subpart that there is **no** danger; or
 - (2) Section 147A.21(d)(2) that there is a danger after ventilation, unless the person in charge of the fumigation notifies him under Sec. 147A. 21(d)(3)(ii) that there is **no** danger.
- (c) If fumigation is **not** completed before the vessel leaves port, the person in charge of the vessel shall ensure that personal protection and fumigant detection equipment for the fumigant that is used is on board the vessel.
- (d) If the vessel leaves port before fumigation is completed, the person in charge of the vessel shall ensure that a qualified person makes periodic inspections until ventilation is completed and this person shall use detection equipment for the fumigant that is used to determine if:
 - (1) There is leakage of fumigant; or

(2) There is a concentration of fumigant that is a danger to the health and safety of any person.

(e) If the qualified person determines under paragraph (d) of this section that there is leakage or a concentration of fumigant that is a danger to the health and safety of any person, the person in charge of the vessel shall take all measures that are, in his discretion, necessary to ensure health and safety of all persons who are on board the vessel. If the danger is due to leakage, he shall also ensure that qualified persons immediately ventilate in accordance with paragraphs (c)(1) and (2) of Sec. 147A.21.

(f) If the vessel leaves port during the exposure period, the person in charge of the vessel shall ensure that the space that is fumigated is ventilated by qualified persons after the exposure period in accordance with paragraphs (c)(1) and (2) of Sec. 147A.21.

(g) If ventilation is completed after the vessel leaves port, the person in charge of the vessel shall ensure that a qualified person, who is wearing the personal protection equipment for the fumigant that is used if remote detection equipment is **not** used, tests the space that is fumigated to determine if there is a danger to the health and safety of any person, including a danger from fumigant that may be retained in bagged, baled, or other absorbent cargo. If the qualified person determines that there is a danger, the person in charge of the vessel shall take all measures that are, in his discretion, necessary to ensure the health and safety of all persons who are on board the vessel.

Sec. 147A.25 Entry.

(a) **No** person may enter the spaces that immediately adjoin the space that is fumigated during fumigation unless entry is for emergency purposes or the space is tested and declared safe for human occupancy by a marine chemist or other qualified person and is inspected under Sec. 147A.21(a)(2) or Sec. 147A.23(d).

(b) If entry is made for emergency purposes:

(1) **No** person may enter the space that is fumigated or any adjoining spaces during fumigation unless he wears the personal protection equipment for the fumigant that is in use;

(2) **No** person may enter the space that is fumigated unless the entry is made by a two person team; and

(3) **No** person may enter the space that is fumigated unless he wears a lifeline and safety harness and each lifeline is tended by a person who is outside the

space and who is wearing the personal protection equipment for the fumigant that is in use.

After Ventilation

Sec. 147A.31 Removal of fumigation material and warning signs.

After ventilation is completed and a marine chemist or other qualified person determines that there is **no** danger to the health and safety of any person under Sec. 147A.21(d) or Sec. 147A.23(g), the person in charge of fumigation or, if the vessel has left port, the person in charge of the vessel shall ensure that all warning signs are removed and fumigation containers and materials are removed and disposed of in accordance with the manufacturer's recommendations.

Special Requirements for Flammable Fumigants

Sec. 147A.41 Person in charge of fumigation; flammable fumigants.

(a) The person in charge of fumigation shall ensure that:

- (1) Before the space that is to be fumigated is sealed, it is thoroughly cleaned, and all refuse, oily waste, and other combustible material is removed;
- (2) Before fumigation, all fire fighting equipment, including sprinklers and fire pumps, is in operating condition; and
- (3) Before and during fumigation, electrical circuits that are in the space that is fumigated are de-energized.

(b) [Reserved]

Sec. 147A.43 Other sources of ignition; flammable fumigants.

While the space that is fumigated is being sealed or during fumigation, **no** person may use matches, smoking materials, fires, open flames, or any other source of ignition in any spaces that are **not** determined to be safe for occupancy under Sec. 147A.11(b)(1)(i).

Appendix C

Conversion Tables

Table C-1 Conversion Tables

To convert from:	To:	Multiply by:
Acres (a)	Hectares (ha)	0.4047
Acres (a)	Square meters (m ²)	4,047.0
Celsius	Fahrenheit	9/5 (then add 32)
Centimeters, cu. (cm ³)	Cubic inches (in ³)	0.061
Centimeters, sq. (cm ²)	Square inches (in ²)	0.155
Centimeters (cm)	Inches (in)	0.3937
Fahrenheit	Celsius	First subtract 32, then multiply by 5/9
Feet, cubic (ft ³)	Liters (L)	28.32
Feet, cubic (ft ³)	Cubic meters (m ³)	0.0283
Feet, square (ft ²)	Square meters (m ²)	0.0929
Feet, square (ft ²)	Sq. centimeters (cm ²)	929.0
Feet (ft)	Centimeters (cm)	30.48
Feet (ft)	Meters (m)	0.3048
Gallons (gal)	Liters (L)	3.785
Grams (g)	Ounces (oz)	0.0353
Hectares (ha)	Acres (a)	2.471
Inches (in)	Centimeters (cm)	2.54
Inches, square (in ²)	Sq. centimeters (cm ²)	6.4516
Inches, cubic (in ³)	Cu. centimeters (cm ³)	16.387
Kilograms (kg)	Pounds (lb)	2.205
Kilograms (kg)	Ounces (oz)	35.27
Kilometers, sq. (km ²)	Square miles (mi ²)	0.3861
Kilometers, sq. (km ²)	Acres (a)	247.1
Kilometers (km)	Miles (mi)	0.6214
Liters (L)	Gallons (gal)	0.2642
Liters (L)	Quarts (qt)	1.0567
Meters, cubic (m ³)	Cubic feet (ft ³)	35.314
Meters, cubic (m ³)	Cubic yards (yd ³)	1.308
Meters (m)	Feet (ft)	3.281
Meters (m)	Yards (yd)	1.0936
Meters, sq. (m ²)	Square inches (in ²)	1,550.00
Meters (m)	Inches (in)	39.37

Table C-1 Conversion Tables (continued)

To convert from:	To:	Multiply by:
Meters, sq. (m ²)	Square feet (ft ²)	10.764
Miles, square (mi ²)	Hectares (ha)	258.99
Miles, square (mi ²)	Sq. kilometers (km ²)	2.5899
Miles, statute (mi)	Meters (m)	1,609.347
Miles, statute (mi)	Kilometers (km)	1.609
Milliliters (ml)	Liquid ounces (lq oz)	0.0338
Nautical miles	Meters (m)	1,852.00
Ounces, fluid (fl oz)	Milliliters (ml)	29.57
Ounces (oz)	Kilograms (kg)	0.0284
Ounces (oz)	Grams (gm)	28.35
Pounds (lb)	Kilograms (kg)	0.4536
Pounds (lb)	Grams (g)	453.6
Quarts (qt)	Liters (L)	0.9464
Tons, short (2000 lb)	Metric tons (t)	0.9072
Tons, Metric (t)	Tons, short	1.102
Yards, cubic (yd ³)	Liters (L)	764.6
Yards, cubic (yd ³)	Cubic meters (m ³)	0.765
Yards (yd)	Meters (m)	0.9144
Yards (yd)	Centimeters (cm)	91.44

Miscellaneous:

- Pounds per acre (lb/a) x 1.1206 = kg/ha
- Ounces (liquid) per acre x 73.14 = ml/ha
- Gallons per acre (gal/a) x 9.3527 = liters per hectare (L/ha)
- Pressure per square inch (PSI) x 6.894757 = kilopascals (kPa)
- Inches mercury x 3.38 = kilopascals (kPa)
- Kilogram per hectare (kg/ha) x 0.8924 = pounds per acre
- Milliliters per hectare x 0.01367 = ounces (lq.) per acre
- Liters per hectare (L/ha) x 0.1069 = gallons per acre
- Kilopascals (kPa) x 0.145038 = pounds per square inch (PSI)
- Grams per liter x 0.008345 = pounds per gallon
- Kilopascals (kPa) x 0.29586 = inches mercury
- Pound per cubic feet = 0.016 grams per cubic meter

Appendix D

APHIS Certified Treatment Facilities and Conveyances

Refer to [Table D-1](#) for hyperlinks to lists of USDA-APHIS-PPQ certified treatment facilities, vessels, and containers.

Table D-1 Hyperlinks to Lists of Certified Treatment Facilities, Vessels, and Containers

Type	Hyperlink
Cold treatment facilities	https://www.aphis.usda.gov/import_export/plants/manuals/ports/downloads/aphis-certified-cold-treatment-facilities.pdf
Fumigation providers in the United States under APHIS compliance agreement	https://www.aphis.usda.gov/import_export/plants/manuals/ports/downloads/fumigation-providers-us-under-compliance-agreement.pdf
Grinding and processing treatment facilities in the United States	https://www.aphis.usda.gov/import_export/plants/manuals/ports/downloads/aphis-certified-grinding-processing-treatment-facilities-us
Heat treatment facilities in the United States	https://www.aphis.usda.gov/import_export/plants/manuals/ports/downloads/aphis-certified-heat-treatment-facilities-us
Irradiation facilities	https://www.aphis.usda.gov/import_export/plants/manuals/ports/downloads/aphis-certified-irradiation-facilities.pdf
Maritime containers and vessels	https://vessels.cphst.org/

Appendix E

Reference Guide to Commercial Suppliers of Treatment and Related Safety Equipment

This list is **not** intended to be all inclusive and is intended to be a reference guide solely for the convenience of potential users, particularly PPQ plant inspection stations. **No** endorsement is intended of the particular items listed, and **no** discrimination is intended toward those products or companies that may **not** be listed.

NOTICE

Product manufacturer names and addresses are subject to change without notice. PPQ does **not** routinely verify the accuracy of the information in this Appendix.

Products

- Aeration Duct, Flexible E-4
- Aerosol Insecticides E-4
- Air Pump, Auxiliary E-5
- Air-Purifying Respirator E-5
- Air Velocity Measuring (Anemometer) E-6
- Aluminum Phosphide E-7
- Applicator (Dispenser) for Methyl Bromide E-8
- Ascarite II E-8
- Balances, Portable (for Weighing Individual Fruit) E-8
- Batch Systems (Complete Installations, Hot Water Immersion Treatments) E-9
- Blower E-12
- Bubble Fumigation System E-12
- Cascade Air Tank Recharging System (for SCBA) E-12
- Chain Hoist (Electronic) (for Hot Water Immersion Treatments) E-12
- Consultants (for Hot Water Immersion Treatments) E-13
- Curtains (Air, Safeguarding) E-14
- Digital Thermistor Instrument (Hand-Held for Hot Water Immersion Treatments) and Portable Sensors (Used in Performance Test) E-14
- Drierite[®] (Anhydrous Calcium Sulfate) E-16
- Electrochemical Gas Sensor and Pyrolyzer E-16
- Exhaust Duct (Tube), Flexible E-16
- Fans E-17
- Fruit Crates (Plastic for Hot Water Immersion Treatments) E-17

Fruit Sizing Equipment (Automatic)	E-17
Fumigators, Commercial	E-17
Fungicides	E-17
Gas Analyzers	E-19
Gas Detector Tube (Colorimetric) and Apparatus	E-20
Gas Drying Tube for Drierite®	E-21
Germicides/Disinfectants	E-22
Halide Gas Leak Detector (removed)	E-22
Incinerators	E-22
Magnesium Phosphide	E-22
Manometer (Used in Pressure Leakage Test)	E-23
Metam-Sodium	E-25
Methyl Bromide	E-25
Moisture Meter (For Wood)	E-27
Newsletters and Trade Journals	E-27
Packaging—Non-Routine USDA-Approved For Fumigation	E-28
Packaging—USDA-Approved For Modified Atmosphere Irradiation	E-29
Packaging—USDA-Approved For Cold Treatment	E-30
Photo Ionization Detector	E-31
Remote Data Transmission Systems	E-31
Safety Equipment	E-31
Scale (Portable Platform)	E-31
Sealing Tape	E-32
Self-Contained Breathing Apparatus (SCBA)	E-32
Smoking Candle	E-33
Snakes (Sand or Water Snakes)	E-33
Soil Fumigants	E-33
Spill Recovery Materials	E-34
Steam Boilers (for Hot Water Immersion Treatments)	E-34
Steam Generators	E-35
Steam Sterilizers/Autoclaves	E-35
Sulfuryl Fluoride (Vikane)	E-35
Tarpaulins	E-35
Temperature Recorders (Portable Type) for Cold Treatment in Self-Regulated Containers	E-36
Temperature Recorders/Controllers (Built-In Type) for Cold Treatment in Self-Regulated Containers	E-37
Temperature Recorders (Portable Type) for Cold Treatment in Warehouses	E-39
Temperature Recorders for Hot Water Immersion Treatment	E-40
Temperature Recorders and Sensors—High Temperature (Niger Seed)	E-43
Thermocouple Wire	E-43
Thermometers	E-44
Thermometers, Glass Mercury, Certified Precision	E-45
Thermometers, Glass Non-mercury, Certified Precision	E-47

Thermometers, Digital, Certified Precision **E-47**
Thermometers, Certified Precision, Approved Calibration Companies **E-51**
Thermometers, Recorders, and Sensors—General Use **E-52**
Tubing, Gas-Sampling **E-54**
Vacuum Pump **E-54**
Vapam **E-55**
Vapor Heat/Forced Hot Air (VH/FHA) Chamber Manufacturers **E-55**
Vapor Heat/Forced Hot Air (VH/FHA) Recorders **E-55**
Volatilizer **E-56**
Warning Signs and Placards **E-57**

Aeration Duct, Flexible

(specify diameter and length)

Biesterfeld, U.S. Inc.

200 Madison Avenue
New York, NY 10016

- ◆ Resmethrin

Fumigation Service and Supply, Inc.

16950 Westfield Park Road
Westfield, IN 46074

Aerosol Insecticides

Gilmore Marketing and Development, Inc.

80 Monroe Street, Suite G1
Memphis, TN 38103

Otis Laboratory

USDA-APHIS-PPQ-S&T
1398 W. Truck Road
Buzzards Bay, MA 02542

- ◆ 10% d-phenothrin

Southern Agricultural Insecticides, Inc.

Mailing Address:

P.O. Box 218
Palmetto, FL 34220

Physical Address:

7400 Bayshore Road
Rubonia, FL 34221

- ◆ Resmethrin

Air Pump, Auxiliary

Barnant

(Sold as Thermo Scientific brand)
28W092 Commercial Avenue
Barrington, IL 60010

Cole-Parmer

625 East Bunker Court
Vernon Hills, IL 60061

- ◆ “Air Cadet” Vacuum/Pressure Pump; Single-J7530-40; dual J7530-60)

McMaster-Carr Supply Co.

P.O. Box 740100
Atlanta, GA 30374-0100

- ◆ Hand-held Mityvac® vacuum/pressure pump, zinc alloy, cat. no. 9963K12)
- ◆ Air-Purifying Respirator (gas masks with cartridge for organic vapors)

Thermo Scientific

81 Wyman Street
Waltham, MA 02454

Air-Purifying Respirator

Air purifying respirators are available from many different companies, including but not limited to Mine Safety Appliances (MSA), ULine, Northern Safety and Industrial, Grainger, etc.

APHIS-approved air purifying respirators are:

- ◆ MSA Advantage (half face) 420 and (full face) 1000
- ◆ 3M (half face) 6100, 6200, 6300 and (full face) 6700, 6800, 6900
- ◆ North (half face) 7700 and (full face) 76008AS, 76008A
- ◆ Survivair/Sperian (half face) 250000, 260000, 270000

For APHIS-approved cartridges, contact a PPQ Field Operations Safety and Health Manager for approved organic vapor/acid gas N95 P100 cartridges.

Air Velocity Measuring (Anemometer)

Extech Instruments®

9 Townsend West
Nashua, NH 03063

- ◆ Mini Thermo-Anemometer Model #45118; Mini Thermo-Anemometer with humidity model #45158

NK Nielson-Kellerman

21 Creek Circle
Boothwyn, PA 19061

- ◆ Kestrel® Pocket Wind Meters (all models)

Trutech Tools

515 Turkey Foot Lake Road
Akron, OH 44319

- ◆ Testo 417 Large Vane Anemometer

TSI, Inc. Alnor Products

500 Cardigan Road
Shoreview, MN 55126

- ◆ Velometer Jr.®

Aluminum Phosphide

Degesch America, Inc.

P.O. Box 116
153 Triangle Drive
Weyers Cave, VA 24486

Fumigation Service and Supply, Inc.

16950 Westfield Park Road
Westfield, IN 46074

Gilmore Marketing and Development, Inc.

80 Monroe Street, Suite G1
Memphis, TN 38103

Helena Chemical Co.

225 Schilling Boulevard, Suite 300
Collierville, TN 38017

ICD Group Metals, LLC

600 Madison Avenue
New York, NY 10022-1615

INCHEMA, Inc.

180 Old Tappan Road, Building 6
Old Tappan, NJ 07675

Loveland Products, Inc.

3005 Rocky Mountain Avenue
Loveland, CO 80538

Pestcon Systems, Inc.

1808 Firestone Parkway
Wilson, NC 27893-7991

United Suppliers, Inc.

Box 538
30473 260th Street
Eldora, IA 50627

- ◆ Applicator (Dispenser) for Methyl Bromide (sight gauges calibrated in ml, grams, or pounds)

Applicator (Dispenser) for Methyl Bromide

Vuscamante North
(Attn: Sr. Maurilio Plata)
307 Montemorelos
Nuevo Leon, Mexico

Ascarite II

(Granules of sodium hydroxide-coated silica used to remove carbon dioxide from gas samples)

Fisher Scientific

2000 Park Lane Drive
Pittsburgh, PA 15275

Sigma-Aldrich Chemical Company, Inc.

6000 North Teutonia Avenue
Milwaukee, WI 53209

Thomas Scientific

P.O. Box 99
99 High Hill Road at I-295
Swedesboro, NJ 08085-0099

Balances, Portable (for Weighing Individual Fruit)

Ohaus Corporation

7 Campus Drive
Suite 310
Parsippany, NJ 07054

Batch Systems (Complete Installations, Hot Water Immersion Treatments)

Agri Machinery and Parts, Inc.
3489 All American Boulevard
Orlando, FL 32810

Agroindustrias Entegradas, S.A. de C.V.
Calle Cernicalo, No. 590
Col. Mor. S.H.C.P. 44490
Guadalajara, Jalisco
Mexico

Calderas Astro, S.A. de C.V.
Jose Herrera, No. 607-B
C.P. 36350
San Francisco del Rincon
Guanajuato, Guan.
Mexico

Construcciones Pyrsa
Depto. de Ingenieria
Anil No. 100
Col. Los Pinos
Celaya, Guanajuato
Mexico

Consultecnia
3a Calle 28-70, Zona 1
Quetzaltenango
Apartado Postal 537-1
Guatemala

Dica de Mexico, S.A.
Corretera - Navolato, km 8
Culiacan, Sinaloa
Mexico

Diseños y Maquinaria Jer, S.A. de C.V. (“Jersa”)

Emiliano Zapata, No. 51-A
Cuatitlan Izcalli
Estado do Mexico, C.P. 54710
Mexico

Equipos Agroindustriales de Occidente, S.A. de C.V.

Avenida Washington, No. 1370
Guadalajara, Jalisco
Mexico

Frutico International

P.O. Box 35-A
Avenida Vallarta 2095
Culiacan, Sinaloa
Mexico

Guiar Industrial, S.A. de C.V.

Rayon No. 989
Colonia Moderna, Sector Juarez
Guadalajara, C.P. 44190, Jalisco
Mexico

◆ “System Model No. 63-89”

Industria de Maquinas Agricolas GB Ltda.

Via Anhanguera, Km 150
Limeira / Sao Paulo
Brazil CEP 13480-970-Cx. Pt. 385

Industrial Equipment & Engineering Co. (I.E. & E.)

2045 Sprint Boulevard
Apopka, FL 32703

NOJOXTEN S.A. de C.V.

Eduardo Velazquez
Av Santa Margarit Razo #283
Santa Margarita
Zapopan, Jalisco CP 45140
Mexico

◆ NOJOXTEN-BR Automation Studio V3.09 IEC 61131-3-ST)

Produce Sorters International

7403 West Sunnyview Avenue
Visalia, CA 93291

Proyect Asesoria Industrial

Av. Los Diplomaticos 1318
San Salvador, El Salvador
or
8a Avenida 33-10, Zona 11
Guatemala, Guatemala

Pyrsa de Celaya

Calle Violeta No. 1204
Colonia Las Flores
Celaya, Guanajuato
Mexico

Silsa, S.A. de C.V.

Avenida Acueducto
597 Planta Alta
Colonia Tecoman
07330 Mexico 14, D.F.
Mexico

William B. Cresse, Inc.

117 Commerce Avenue
Lake Placid, FL 33852

Blower

(Used in pressure leakage test; may also be used to evacuate a fumigation chamber)

W.W. Grainger, Inc.
Branch offices in various cities

William W. Meyer & Sons, Inc.
1700 Franklin Boulevard
Libertyville, IL 60048-4407

Bubble Fumigation System

Inflatable tarpaulin

B&G Equipment Company
135 Region South Drive
Jackson, GA 30233

Power Plastics
Station Road
Thirsk, N. Yorkshire Y07 1PZ
England

Cascade Air Tank Recharging System (for SCBA)

Mine Safety Appliance Co. (MSA)
1000 Cranberry Woods Drive
Cranberry Twp, PA 16066

Chain Hoist (Electronic) (for Hot Water Immersion Treatments)

Chemonics
1717 H Street, NW
Washington, DC 20006

◆ Post-harvest advice; international consulting)

Columbus McKinnon Corp.
Industrial Products Division
140 John James Audubon Parkway
Amherst, NY 14228

- ◆ Lodestar electronic chain hoist, capacity to 3 tons

Consultants (for Hot Water Immersion Treatments)

C.C. Coutinho Consulting
Av. Princess Leopddina, 238
Ap. 101 D
Graca - Ed Olga Pontes
Cep 40150-080 Salvador, Bahia
Brazil

USDA-APHIS-PPQ Science and Technology
USDA-APHIS-PPQ-S&T-TMT
13601 Old Cutler Road, Bldg. 63
Miami, FL 33158 USA

- ◆ APHIS technical contact; approval of plans and drawings

Consultecnia
3a Calle 28-70, Zona 1
Quetzaltenango
Aparto Postal 537-1
Guatemala

Dica de Mexico, S.A.
Corretera - Navolato, km 8
Culiacan, Sinaloa
Mexico

Frutico International
P.O. Box 35-A
Avenida Vallarta 2095
Culiacan, Sinaloa
Mexico

GEC Instruments

5530 NW 97th Street
Gainesville, FL 32653

- ◆ Engineering consulting

Nojoxten

Sta. Martha No. 276-A Col. Sta.
Margarita C.P. 45140
Zapopan, Jalisco
Mexico

North Bay Produce, Inc.

10a Calle 1-4, Zona 9
Guatemala, Guatemala

Societe d'Entretien & d'Installation (SODEIN)

Route de Carrefour #83
P.O. Box 995
Port-au-Prince, Haiti

- ◆ Installation of temperature recording equipment, especially the Chessel 346

Curtains (Air, Safeguarding)

W.W. Grainger, Inc.

Branch offices in many cities

Digital Thermistor Instrument (Hand-Held for Hot Water Immersion Treatments) and Portable Sensors (Used in Performance Test)

Advanced Industrial Services, Inc. (AIS)

3250 Susquehanna Trail
York, PA 17406

- ◆ YSI 400 series thermistor sensors

Allied Electronics

15721 NW 60th Avenue

Miami Lakes, FL 33014
(Additional sales outlets in other cities)

- ◆ Instruments include Cooper Instrument Corp.'s Model TM99A, and thermister sensors with submersible 10 or 20 ft. cord, Catalog No. 2010

Contech

Rafael G. De Avila Aceves
Miguel Galindo 2033, J. del Country
Guadalajara, Jalisco, Mexico, C.P. 44210

- ◆ Term 2252 thermometer; sensors SP20758-1 (see Measurement Specialties) and adapter Part #364-A for Oakton Acorn Temp 4) and sensors with YSI 400 series sensors (see Advanced Industrial Services, Inc. (AIS))

Cooper Instrument Corp.

33 Reeds Gap Road
Middlefield, CT 06455

(Note: This company manufactures the Cooper instruments sold by Allied Electronics, but does **not** sell directly to retail customers.)

Oakton Instruments

P.O. Box 5136
Vernon Hills, IL 60061

- ◆ Acorn® Temp 4 Meter: use 400 series thermistor probe. Suggested general purpose probes are:
 - ❖ Oakton air probe #WD-08491-08
 - ❖ Oakton penetration probe #WD-08491-16
 - ❖ Oakton general purpose probe 10, 50, or 100 feet #WD-08491-02, #WD-08491-03, #WD-08491-04
 - ❖ Oakton Acorn® Temp 5 #EW-35626-10
- ◆ Oakton products can be purchased at numerous distributors such as Cole-Parmer, Davis Instruments, etc.
- ◆ Recommended temperature sensors for Acorn® Temp 4.5 and 6 are from **Measurement Specialties**.

Measurement Specialties

2670 Indian Ripple Road
Dayton, OH 45440

- ◆ Sensor Model SP20758-1, long term immersion sensor with 4-meter cable for use with Acorn® Temp 4, 5, and 6. Use **Switchcraft** adapter Part #364-

A to connect sensor to Acorn® Temp 4, 5, and 6. Two conductor adapters from 3.5mm to phone jack mono to 6.35 phone jack mono.

Switchcraft, Inc.
555 N. Elston Ave.
Chicago, IL 60630

- ◆ Adapter Part #364-A (to connect SP20758-1 to the Acorn® Temp 4

Drierite® (Anhydrous Calcium Sulfate)

Fisher Scientific
2000 Park Lane Drive
Pittsburgh, PA 15275

Sigma-Aldrich Chemical Company, Inc.
6000 North Teutonia Avenue
Milwaukee, WI 53209

W.A. Hammond Drierite Co. (Manufacturer)
138 Dayton Avenue
Xenia, OH 45385

Electrochemical Gas Sensor and Pyrolyzer

PureAir Monitoring Systems, Inc.
557 Capital Drive
Lake Zurich, IL 60047

Exhaust Duct (Tube), Flexible

Stock sizes available in diameters of 12, 16, and 24 inches. Available in 10 and 20 feet lengths, which may be attached by a ring coupling.

Gaskets, Inc.
301 W. Highway 16
Rio, WI 53960

Super Vacuum Manufacturing Company, Inc.
P.O. Box 87
Loveland, CO 80539-0087

Fans

Super Vacuum Manufacturing Company, Inc.
P.O. Box 87
Loveland, CO 80539-0087

Fruit Crates (Plastic for Hot Water Immersion Treatments)

No listings.

Fruit Sizing Equipment (Automatic)

Hortagro International, b.v.
P.O. Box 4050
8901 EB Leeuwarden
Holland

- ◆ Mechanical weight sizer with conveyor belt

Kerian Machines, Inc.
1709 Highway 81 South
P.O. Box 311

- ◆ Roller type of sizing equipment
-

Fumigators, Commercial

Refer to your preferred Internet search engine to locate commercial fumigators.

Fungicides

Bordeaux Mixture (hydrated lime + copper sulfate)

Chemtura Corporation

199 Benson Road
Middlebury, CT 06749

- ◆ Product name: Nutra-Spray, Captan

Crystal Chemical Inter-America

6800 SW. 40th Street, Suite 499
Miami, FL 33155-3708

- ◆ Product Name: Captanex

Drexel Chemical Co.

P.O. Box 13327
Memphis, TN 38113-0327
Phone: (901) 774-4370

Syngenta

1800 Concord Pike
P.O. Box 8353
Wilmington, DE 19803

- ◆ Ferbam

Cytec Industries, Inc.

5 Garrett Mountain Plaza
West Patterson, NJ 07424

- ◆ Product names: Carbamate WDB, Ferbam 76 WDG, Ferbam Granuflo

FMC Agricultural Products

Chemical Group
1735 Market Street
Philadelphia, PA 19103

- ◆ Product names: Carbamate, Mancozeb

Arkema, Inc.

2000 Market Street
Philadelphia, PA 19103-3222

- ◆ Product name: Penncozeb 80 WP

Rohm and Haas

100 Independence Mall West
Philadelphia, PA 19106

- ◆ Product names: Dithane, Thiram

Bayer CropScience LP

P.O. Box 12014
2 T.W. Alexander Drive
Research Triangle Park, NC 27709

- ◆ Product names: Cuprothex Super Mix

Cytec Industries, Inc.

5 Garrett Mountain Plaza
West Patterson, NJ 07424

- ◆ Product names: Tech TMTD, Thianosan, THiLor, Thipel, Thiram
Granuflo, Thiram 65, Thiram 75-WDG, Zineb

Gas Analyzers

Analytical Technology, Inc.

6 Iron Bridge Drive
Collegeville, PA 19426

- ◆ PortaSens Phosphine Detector

EB & S Solutions

6587 66th Avenue North
Pinellas Park, FL 33781

Interscan Corporation

4590 Ish Drive, #110
Simi Valley, CA 93063

- ◆ Interscan Model GF 1900 pyrolysis unit, sensitive to SF at 0–50 ppm.)

Key Chemical and Equipment Co., Inc.

13195 49th Street North, Unit A
Clearwater, FL 33762

- ◆ Fumiscope, Models D, 4.0, 4.2, and 5.12

Neal Systems, Inc.

122 Terry Drive
Newtown, PA 18940

- ◆ Porta-Sens Phosphine Detector

Pest Fog, Inc.

1424 Bonita
P.O. Box 3703
Corpus Christi, TX 78463

Spectros Instruments, Inc.

17D Airport Road
Hopedale, MA 01747

- ◆ Methyl bromide monitor MB-ContainIR
- ◆ Sulfuryl fluoride monitor SF-Contain IR

Gas Detector Tube (Colorimetric) and Apparatus

APHIS/NOAA Centralized Warehouse

(**must** order by Fedstrip procedure)

- ◆ FTS: 758-6222 (Draeger tubes)

Draeger Safety, Inc.

101 Technology Drive
Pittsburgh, PA 15275-1057

- ◆ Draeger tubes in the ranges of 0.2–8.0 ppm Product #8103391; and 0.5–30.0 ppm Product #8101671

Lab Safety Supply
is now W.W. Grainger, Inc.
Branch offices in various cities

Matheson TriGas

- ◆ Matheson-Kitagawa tubes in the range 0.5–10 ppm Product #8014-187sc

Protech Safety Equipment

37 East 21st Street
P.O. Box 455
Linden, NJ 07036

- ◆ Draeger tubes

Sensidyne, LP

16333 Bay Vista Drive
Clearwater, FL 33760

- ◆ Sensidyne/Gastec tubes in the range of 0.1–20 ppm Product #157SD

SKC, Inc.

863 Valley View Road
Eighty Four, PA 15330

Union Carbide Corp., Linde Division

National Specialty Gases Office
40 Veronica Avenue
Somerset, NJ 08873-3498

- ◆ Sensidyne/Gastec tubes and apparatus

Gas Drying Tube for Drierite®

Wilmad-LabGlass

1172 NW Boulevard
Vineland, NJ 08360

- ◆ Glass tube: Catalog #301-7501

Germicides/Disinfectants

Georgia-Pacific Corp.
300 W. Laurel Street
Bellingham, WA 98225

Halide Gas Leak Detector (removed)

Incinerators

Whitten Technology, Inc.
Air Burners Products Division
4390 Cargo Way
Palm City, FL 34990

◆ Air Curtain Incinerators

Magnesium Phosphide

Degesch America, Inc.
P.O. Box 116
153 Triangle Drive
Weyers Cave, VA 24486

Fumigation Service and Supply, Inc.
16950 Westfield Park Road
Westfield, IN 46074

Helena Chemical Co.
225 Schilling Boulevard, Suite 300
Collierville, TN 38017

Manometer (Used in Pressure Leakage Test)

Select the device based on pressure range and suitability.

Amazon

- ◆ Digital, Magnehelic, U-tube

Cole-Parmer

625 East Bunker Court
Vernon Hills, IL 60061

- ◆ Digital, Magnehelic, U-tube

Davis Calibration

1946 Greenspring Drive, Suite A
Timonium, MD 21093

- ◆ Digital, U-tube

Dwyer Instruments, Inc.

102 Indiana Highway 212
Michigan City, IN 46360

- ◆ Digital, Magnehelic, U-tube

E&E Process Instrumentation
4-40 North Rivermede Road
Concord, ON L4K 2H3

- ◆ Digital, Magnehelic, U-tube

Extech

9 Townsend West
Nashua, NH 03063

Digital, Magnehelic

Fisher Scientific

2000 Park Lane Drive
Pittsburgh, PA 15275

- ◆ Digital, Magnehelic, U-tube

Instrumart

35 Green Mountain Drive
S Burlington, VT 05403

- ◆ Digital, Magnehelic

LabX

- ◆ Digital, used

Meriam Process Technologies

10920 Madison Avenue
Cleveland, OH 44102

MSC Industrial Supply

75 Maxess Road
Melville, NY 11747-3151

- ◆ Digital

OMEGA Engineering, Inc.

800 Connecticut Avenue
Suite 5N01
Norwalk, CT 06854

- ◆ Digital

TruTech Tools

- ◆ Digital

W.W. Granger, Inc.

Branch offices in many cities.

Zellweger Analytics

Neotronics Sieger Solomat Division
4331 Thurmond Tanner Road
P.O. Box 2100
Flowery Branch, GA 30542

- ◆ Model No. 530 (0–19.99 inches of water)

Metam-Sodium

Amvac Chemical Corporation
4100 East Washington Boulevard
Los Angeles, CA 90023

Methyl Bromide

Biesterfeld, U.S. Inc.
200 Madison Avenue
New York, NY 10016

Chemtura Corporation
199 Benson Road
Middlebury, CT 06749

Table E-1 Cylinder Tare, Net, and Gross Weights

Net Weight Product Description	Cylinder Tare Weight (lbs.)	Cylinder Net Weight (lbs.)	Cylinder Gross Weight (lbs.)	Comments
50 lbs–short	25	50	75	
50 lbs–tall	30	50	80	Used for Meth-O-Gas Q only
100 lbs	35	100	135	
175 lbs	50	175	225	
200 lbs	50	200	250	
1,500 lbs	350	1,500	1,850	

Degesch America, Inc.

Houston Division
P.O. Box 451036
Houston, TX 77245

Fumigation Service and Supply, Inc.

16950 Westfield Park Road
Westfield, IN 46074

Helena Chemical Co.

225 Schilling Boulevard, Suite 300
Collierville, TN 38017

ICD Group Metals, LLC

600 Madison Avenue
New York, NY 10022-1615

ICL Industrial Products (formerly Ameribrom, Inc.)

622 Emerson Road, Suite 500
St. Louis, MO 63141

Pestcon Systems, Inc.

1808 Firestone Parkway
Wilson, NC 27893-7991

Southern Agricultural Insecticides, Inc.

Mailing Address:

P.O. Box 218
Palmetto, FL 34220

Physical Address:

7400 Bayshore Road
Rubonia, FL 34221

Moisture Meter (For Wood)

Delmhorst Instrument Company

51 Indian Lane East
Towaco, NJ 07082

- ◆ Order: Moisture Meter G30
Electrode 26ES
Type 496 pin
(Above comes as package in carrying case)

Lignomat USA Ltd.

14345 NE Morris Court
Portland, OR 97230

Newsletters and Trade Journals

(containing articles on fumigation)

Fumigants and Pheromones

(free newsletter)

Fumigation Service and Supply, Inc.
16950 Westfield Park Road
Westfield, IN 46074

Pest Control Technology

(monthly for professional pest control operators)

4020 Kinross Lakes Parkway, Suite 201
Richfield, OH 44286

Pest Management Professional

(monthly for professional pest control operators)

Questex Media Group, Inc.
600 Superior Avenue East, Suite 1100
Cleveland, OH 44114
Customer Service Mailing Address:
Pest Management Monthly
P.O. Box 2090
Skokie, IL 60076-7990

Packaging—Non-Routine USDA-Approved For Fumigation

Non-routine packaging is approved by S&T upon request. Contact ppqmt@usda.gov for specifications for approval.

NOTICE

See [Packaging Materials Approved for Fumigation](#) on page 2-3-8 for a list of routine packaging.

Dupont™ Tyvek® Air Cargo Covers (approved for methyl bromide fumigation only)
12316 Amoretto Way
Raleigh, NC 27613
USA

Los Tres Castillos Ltda. (approved for methyl bromide fumigation only)
Bombero Gabriel Lima Millán N°1417
San Ramón
Santiago, Chile

PACKFRESH SPA (approved for methyl bromide fumigation only)
Camino Lonquen
Sur Paradero #18
Calera de Tango, Santiago, Chile

PSS Envases SA (PacLife) (approved for methyl bromide fumigation only;
see also [Packaging—USDA-Approved For Cold Treatment](#))
Los Duraznos 0683
La Pintana, Región Metropolitana
Chile

Quimas S.A. (SmartPac) (approved for methyl bromide fumigation only)
Los Yacimientos 1301
Maipu
Santiago, Chile

VIJOM (approved for methyl bromide fumigation only)
Manufacturas de Plásticos Vijom Ltda.
Escorial s/n
Panquehue
San Felipe, Chile

VK Packaging SPA (approved for methyl bromide fumigation only)
Av Las Industrias 5155
San Antonio, V Region, Chile

Packaging—USDA-Approved For Modified Atmosphere Irradiation

Modified atmosphere irradiation packaging is approved by S&T upon request.
Contact ppqmt@usda.gov for specifications for approval.

Ancor AFAP
15 Keys Road Moorabbin
Victoria 3189
Australia

Aypek Packaging
NOSAB SEDIR CAD No. 15
PK 16140 Nilufer
Bursa, Turkey

Chantler Packages Inc. 880 Lakeshore Road East
Mississauga, ON
Canada L5E 1E1

San Jorge Packaging SA

Avenida Einstein 923
Recoleta, Santiago, Chile

StePac L.A. Ltd.

Tefen Industrial Park
Building 12
P.O. Box 73
Tefen
Israel 2495900

TrendLife Deka Plastik Ltd. Sti.

Dogu Sanayi Sitesi 9. Blok No:11 Yenibosna
Istanbul
Turkey

Packaging—USDA-Approved For Cold Treatment

Cold treatment packaging is approved by S&T upon request. Contact ppqmt@usda.gov for specifications for approval.

INDUPACK

Elias Aguirre 358 Of. 102
Miraflores, Lima, Peru

Liventus

Estoril 120 Torre A - Of. 716
Las Condes
Santiago, Chile

PSS Envases SA (PacLife)

Los Durazos 0683
La Pintana, Región Metropolitana
Chile

SURAGRA

Calle Chinchon 830 Of. 301
San Isidro Lima 27
Peru

Photo Ionization Detector

Mine Safety Appliances Co. (MSA)

1000 Cranberry Woods Drive
Cranberry Twp, PA 16066

- ◆ Sirius Multigas Detector

Rae Systems

3775 North First Street
San Jose, CA 95134

Remote Data Transmission Systems

A.P. Moller-Maersk A/S
180 Park Avenue
Florham Park, NJ 07932

- ◆ Remote Container Management System

Safety Equipment

United States Plastic Corporation

1390 Neubrecht Road
Lima, OH 45801-3196

- ◆ Safety guards for belt and chain drives; fan guards; fire extinguishers; safety equipment in general

Scale (Portable Platform)

(for weighing gas cylinders) Refer to your preferred Internet search engine for additional manufacturers.

Arlington Scale Co., Inc.

38 Davey Street
Bloomfield, NJ 07003

Atlantic Scale Co., Inc.

136 Washington Avenue
Nutley, NJ 07110

- ◆ See website for other locations in Hicksville, NY and Yonkers, NY

Eastern Scale of NJ
1053 Pennsylvania Avenue
Linden, NJ 07036-2240

Phifer Incorporated
Mailing address:
P.O. Box 1700
Tuscaloosa, AL 35403-1700
Shipping Address:
4400 Kauloosa Avenue
Tuscaloosa, AL 35401-7042

- ◆ Fiberglass insect screening of various mesh sizes and colors

Sealing Tape

Degesch America, Inc.
Houston Division
P.O. Box 451036
Houston, TX 77245

Fumigation Service and Supply, Inc.
16950 Westfield Park Road
Westfield, IN 46074

- ◆ ARMAK sealing tape

Self-Contained Breathing Apparatus (SCBA)

Mine Safety Appliances Co. (MSA)
MSA World Headquarters
Customer Service Center
P.O. Box 426
Pittsburg, PA 15230

- ◆ MAS AirHawk Ultra Elite
USDA employees monitoring fumigations **must** order model ATO#A-A2LB33A00F11AA1. The letter “F” is the size of the face mask. “F” is medium, “G” is large, and “E” is small. Spectacle kits: center support part #493581 or sidewire part #804638.

Smoking Candle

(Candles of various sizes used in pressure leakage test.)

NOTICE

Purchase **only** candles that emit white smoke. If candles that emit colored smoke are used, their residue will stain the interior walls of the fumigation chamber, skin, and clothing. Store candles in a dry, cool place.

Superior Signal Co., Inc.
P.O. Box 96
Spotswood, NJ 08884

Snakes (Sand or Water Snakes)

Fumigation Service and Supply, Inc.
16950 Westfield Park Road
Westfield, IN 46074

Soil Fumigants

(Metam-Sodium, Vapam, etc.)

Buckman Laboratories International Inc.
1256 North McLean Boulevard
Memphis, TN 38108-1241

- ◆ Product name: Busan 1020

Cytec Industries, Inc.
5 Garrett Mountain Plaza
West Patterson, NJ 07424

- ◆ Products: Metam 32.7, Metam 42, Ucetam

OR-CAL, Inc.
29454 Meadowview Road
Junction City, OR 97448

- ◆ Product name: Sectagon

Syngenta
1800 Concord Pike
P.O. Box 8353
Wilmington, DC 19803

- ◆ Product name: Vapam

Spill Recovery Materials

This section lists products to absorb spills of hazardous materials.

Ansul
One Stanton Street
Marinette, WI 54143

- ◆ Product: Spill-X

Fumigation Service and Supply, Inc.
16950 Westfield Park Road
Westfield, IN 46074

New Pig Corp.
One Pork Avenue
P.O. Box 304
Tipton, PA 16684-0304

WYK Sorbents, LLC
11721 Lackland Road
St. Louis, MO 63146

- ◆ Product: absorbent pillows and socks (free samples available)

Steam Boilers (for Hot Water Immersion Treatments)

Fulton Boiler Works, Inc.
3981 Port Street
Pulaski, NY 13142

- ◆ oil-fired, gas-fired, or combination

Steam Generators

Sioux Corporation
One Sioux Plaza
Beresford, SD 57004

Steam Sterilizers/Autoclaves

Environmental Tectonics Corporation
125 James Way
Southampton, PA 18966

Sulfuryl Fluoride (Vikane)

Dow AgroSciences LLC
9330 Zionsville Road
Indianapolis, IN 46268

Southern Agricultural Insecticides, Inc.
Mailing Address:
P.O. Box 218
Palmetto, FL 34220
Physical Address:
7400 Bayshore Road
Rubonia, FL 34221

Tarpaulins

Tarpaulins for fumigation are made by many companies. Use your preferred Internet search engine to find additional manufacturers.

Elastec/American Marine
1309 West Main
Carmi, IL 62821
(see website for other locations)

Poly-Flex, Inc.
2000 W. Marshall Drive
Grand Prairie, TX 75051

Raven Industries
205 E. 6th Street
Sioux Falls, SD 57104

Reef Industries, Inc. (Griffolyn Division)
9209 Alameda Genoa
Houston, TX 77075

- ◆ Product: Inflatable tarpaulin (see “Bubble Fumigation System”)

Temperature Recorders (Portable Type) for Cold Treatment in Self-Regulated Containers

Controlyne, Inc.
14 Highpoint
Cedar Grove, NJ 07009

- ◆ ACR SmartReader 8 Logger)

DeltaTRAK, Inc.
P.O. Box 398
Pleasanton, CA 94566

- ◆ DeltaTrak T-8, DeltaTrak CDX-100, CDX-300, CDX-22000

GE Sensing (formerly Kaye Instruments)
1100 Technology Park Drive
Billerica, MA 01821

- ◆ Model DR-2B Digistrip II

International Reactor Corporation
521 Kiser Street
Dayton, OH 45404

- ◆ Grant Squirrel Meter/Logger, Squirrel 2020 series with thermistors or PT100 sensors

Metrosonics, Inc.

1060 Corporate Center Drive
Oconomowoc, WI 53066

- ◆ DocuTemp 714A

Remonsys Limited

The Stables
Church Hanborough
WITNEY
Oxfordshire OX29 8AB
United Kingdom

- ◆ Autolog Time/Temperature Monitor, AUTOLOG 2000 Data Logger, Multilog2

Sensitech, Inc.

800 Cummings Center
Suite 258X
Beverly, MA 01915-6197

- ◆ Data Mentor, RTM 2000 CTU

Wescor, Inc.

370 West 1700 South
Logan, UT 84321

- ◆ Datapod

Temperature Recorders/Controllers (Built-In Type) for Cold Treatment in Self-Regulated Containers

Carrier Transicold Division

Carrier Corporation
United Technologies
P.O. Box 4808, Carrier Parkway
Syracuse, NY 13221-4808

- ◆ Micro Link 2 DataCorder
- ◆ Micro Link 2i Controller/DataCorder
- ◆ Micro Link 3 DataCorder
- ◆ Micro Link 3i DataCorder
- ◆ Micro Link 4 Controller
- ◆ Micro Link 5 Controller

Daikin Industries, Ltd.

Umeda Center Building, 2-4-12
Nakazaki-Nishi, Kita-ku, Osaka,
530-8323, Japan

- ◆ Decos III Microproc. Temp. Controller
- ◆ Decos IIIA, Decos IIIB
- ◆ Decos IIIC
- ◆ Decos IIID
- ◆ DecosIIIE
- ◆ DecosIIIF
- ◆ DecosIIIG
- ◆ DecosIIIH
- ◆ DecosIIIi
- ◆ DecosIIIJ
- ◆ Decos V
- ◆ Decos Va

Denso Corporation

1-1 Showa-Cho
Kariya, Aichi 44808661
Japan

- ◆ Deft1000

Klinge Corporation

4075 East Market Street
York, PA 17402

- ◆ ThermLogger II

Maersk Container Industry

Qingdao Ltd.
2 Lu, Weishan Cun, Liuting Zhen
Cheng Yang Qu
Qingdao, China

- ◆ StarCool units CIM5 and CIM6

Matrix Dynamics

501 Doylestown Road
Lansdale, PA 19446

- ◆ Road Warrior 1, HACCP Warrior

Mitsubishi Heavy Industries

3-1, Asahi, Nishi, biwajima-cho, kiyosu,
Aichi Prefecture, 452-8561, Japan

- ◆ MMCC III & MMCC IIIA, MMCC IIIA-47B

Thermo King Corporation

314 West 90th Street
Minneapolis, MN 55420

- ◆ Thermoguard PA Microprocessor Temperature Controller
- ◆ MP-D Microprocessor Controller
- ◆ Thermoguard PA+ Microprocessor Controllers) (MP-2000, MP-3000, MP-3000a, MP-4000)

Temperature Recorders (Portable Type) for Cold Treatment in Warehouses

Computer Aided Solutions

8437 Mayfield Rd., Unit 104
Chesterland, OH 44026

- ◆ Products: RTR-505-Pt Wireless Data Logger
- ◆ Sensors: thermistor Pt 100

Evidencia LLP

505 Tennessee Street, Suite 502
Memphis, TN 38103

- ◆ Products: ThermAssureRF, ThermProbeRF

Fluke Electronics Corporation

Comark Instruments

P.O. Box 500
Building 50-209
Beaverton, OR 97077

- ◆ Comark RF500; RF500A/USA, and RF500AP/USA Wireless Temperature Monitoring System

Inteligistics, Inc.

210 William Pitt Way, A11
Pittsburgh, PA 15238

- ◆ TES-31 wireless recorder, USP14966 sensor

Madge Tech

6 Warner Road
Warner, NH 03278

- ◆ Model RFOT wireless temperature logger, sensors: RFOT-FR, RFOT-4, RFOT-4-TD, RFOT-7, RFOT-12

MicroDAQ.com LTD

879 Maple Street
Contoocook, NH 03229

- ◆ RTR-505-Pt wireless data logger; sensors: thermistor Pt 100

Temperature Recorders for Hot Water Immersion Treatment

Agri Machinery and Parts, Inc.

3489 All American Boulevard
Orlando, FL 32810

- ◆ Honeywell strip chart recorders

Conax Technologies

2300 Walden Avenue
Buffalo, NY 14225

Contech

Avenida Circunvalacion #1590
Jardine Del Country, C.P. 42210
Guadalajara, Jalisco
Mexico

- ◆ Contech data logger

Electro Scientific Industries, Inc.

13900 Science Park Drive
Portland, OR 97229-5497

- ◆ Dekabox Delade Resister Instrument, Model No. DB62, which may be used in the calibration of RTD sensors

Enterprise S.A. de C.V.

Rodriguez Saro 424
Colonia del Valle

03100 Mexico D.F.
Mexico

- ◆ Honeywell and Molytek 2702 temperature recorders

Equipos Industriales Guadalajara

Aguador No. 3959-A
Int. 5 Fracc. La Calma
C.P. 45070, Zapopan, Jalisco

- ◆ Honeywell instruments

Eurotherm Chessell

44621 Guilford Drive, Suite 100
Ashburn, VA 20147

- ◆ Chessel strip-unit recorder, Model 346

Guiar Industrial, S.A. de C.V.

Rayon No. 989
Colonia Moderna
Sector Juarez
Guadalajara, C.P. 44190, Jalisco
Mexico

- ◆ Honeywell instruments)

Honeywell International, Inc.

101 Columbia Road
Mailstop - M6/LM
Morristown, NJ 07962

- ◆ Honeywell instruments)

Instrumentacion y Control Industrial

Santa Martha No. 269
Zapopan, Jalisco
Mexico

- ◆ National and Honeywell instruments

Laboratorios Jael

Automation Division
Calle 2 Norte #7
Parque Industrila Francisco I. Madero
Puerto Chiapas, Tapachula, Chiapas
Mexico

- ◆ HyThsoft v 2

Nanmac Corporation

11 Mayhew Street
Framingham, MA 01702

- ◆ Nanmac data logger, Model H30-1

National Instruments Corporation

11500 N. Mopac Expressway
Austin, TX 78759-3504

- ◆ National Instruments

Neuberger Messinstrumente GmbH

Steinerstr 16, D-8000
Munche, Germany

- ◆ Neuberger strip chart recorder P1Y

NOJOXTEN S.A. de C.V.

Eduardo Velazquez
Av Santa Margarit Razo #283
Santa Margarita
Zapopan, Jalisco CP 45140
Mexico

- ◆ NOJOXTEN-BR Automation Studio V3.09 IEC 61131-3-ST

NZ Automacao Ltda-ME

R. Areal
99 - Box Retiro 01125-20
Sao Paulo SP

Process Technologies, Inc.

154 Whitaker Road
Tampa, FL 33549

Telecontrol Y Sistemas Automaticos Sac

Tacna 230 La Arena
Piura, Peru

Vacuum Research Corp.

2419 Smallman Street
Pittsburgh, PA 15222

- ◆ Molytek temperature recorder, Model 2702

William B. Cresse, Inc.

P.O. Box 906
117 Commerce Avenue
Lake Placid, FL 33852

- ◆ Honewell strip chart recorder; Temperature Sensors TRD, 100 ohm

Temperature Recorders and Sensors—High Temperature (Niger Seed)

Madge Tech Inc.

879 Maple Street
Contoocook, NH 03229 or
P.O. Box 50
Warner, NH 03278

- ◆ Product: Model HiTemp 140

Omega Engineering, Inc.

P.O. Box 4047
One Omega Drive
Stamford, CT 06907-0047

- ◆ Product: Model OM-CP-HiTemp 140

Mesa Laboratories, Inc.

Data Trace Division
12100 West 6th Avenue
Lakewood, CO 80228

- ◆ Models: Data Trace Hi Temp Micropack III

Thermocouple Wire

Omega Engineering, Inc.

P.O. Box 4047
One Omega Drive
Stamford, CT 06907-0047

- ◆ Product: Type “T” thermocouple wire Catalog No. PR-T-24

Thermometers

Cole-Parmer

625 East Bunker Court
Vernon Hills, IL 60061

- ◆ Product: Digital thermometers, hand-held; EW-90080-09 Scientific Thermistor Thermometer with USB

Contech

Rafael G. De Avila Aceves
Miguel Galindo 2033, J. del Country
Guadalajara, Jalisco, Mexico, C.P. 44210

- ◆ Product: Term 2252 thermometer; sensors SP20758-1 (see Measurement Specialties) and adapter Part #364-A for Oakton Acorn Temp 4) and sensors with YSI 400 series sensors (see Advanced Industrial Services, Inc. (AIS))

Cooper Atkins

33 Reeds Gap Road
Middlefield, CT 06455

- ◆ Product: Electro-Therm hand-held digital thermometer. Instrument Model Tm-99a (Electro-Therm), general purpose air/surface probes, 12 feet in length, Cat. #20-10, puncture probe #1075 (no longer comes with offset adjustment to change the temperature to true temperature with the aid of a reference thermometer)

Davis Instruments

625 East Bunker Court
Vernon Hills, IL 60061-1844

Oakton Instruments

P.O. Box 5136
Vernon Hills, IL 60061

South/Latin America

- ◆ Product: Acorn® Temp 4 Meter (use 400 series thermistor probe; suggested general purpose probes are: Oakton air probe #WD-08491-08; Oakton penetration probe #WD-08491-16; Oakton general purpose probe 10, 50, or 100 feet #WD-08491-02, #WD-08491-04, #WD-08491-03)

Omega Engineering, Inc.

P.O. Box 4047
 One Omega Drive
 Stamford, CT 06907-0047

Thermo Electric Company, Inc.

60-A Commerce Way
 Totowa, NJ 07512

- ◆ Product: Micromite indicator/calibrator: Model 3115-1-T-0-1-0-1
 Probe for Micromite: Model T-18-G-304-0-036-4M1

Thermometers, Glass Mercury, Certified Precision

These thermometers are used as calibration standards in cold treatment, hot water dip treatment, and hot air treatment.

Thermometers from other sources may be considered, as long as they meet the specifications outlined in Chapter 8: [Equipment](#).

Request approval for thermometers from:

USDA-APHIS-PPQ-S&T-TMT
 13601 Old Cutler Road, Bldg. 63
 Miami, FL 33158 USA
 Phone: 305-278-4877
 Fax: 305-278-4898
 email: ppqmt@usda.gov

DC Scientific Glass

Mail. P.O. Box 1099
 Pasadena, MD 21123
 Physical Location: 510 McCormick Drive, Suite D
 Hanover, MD 21076

Table E-2 DC Scientific Glass - Approved Thermometers

Catalog No.	Type	Range	Scale Division	Calibration Points	Length (mm)	Immersion
210-624	Extreme Precision	30 to 124 °F	0.1 °F	Minimum of one at the treatment temperature	610	Total
210-626	Extreme Precision	30 to 124 °F	0.1 °F	Minimum of one at the treatment temperature	610	3 inches

Table E-2 DC Scientific Glass - Approved Thermometers (continued)

Catalog No.	Type	Range	Scale Division	Calibration Points	Length (mm)	Immersion
10064F-C	ASTM	77 to 131 °F	0.2 °F	5 calibration points (32, 80, 95, 115, 130 °F)	379	Total
10064C-C	ASTM	25 to 55 °C	0.1 °C	5 calibration points (0, 25, 35, 45, 55 °C)	379	Total
67C-100MM-C	ASTM	95 to 155 °C	0.2 °C	5 calibration points (0, 100, 110, 130, 150 °C)	379	100 mm

Fisher Scientific
 2000 Park Lane Drive
 Pittsburgh, PA 15275

Table E-3 Fisher Scientific - Approved Thermometers

Catalog No.	Type	Range	Scale Division	Calibration Points	Length (mm)	Immersion
15-142C	ASTM Mercury	77 to 131 °F	0.2 °F	5 calibration points (32, 80, 95, 115, 130 °F)	379	Total
15-140C	ASTM Mercury	25 to 55 °C	0.1 °C	5 calibration points (0, 25, 35, 45, 55 °C)	379	Total
15-169-120	ASTM Mercury	95 to 155 °C	0.2 °C	5 calibration points (0, 100, 110, 130, 150 °C)	379	Total

VWR
 1310 Goshen Parkway
 Westchester, PA 19380

Table E-4 VWR - Approved Thermometers

Catalog No.	Type	Range	Scale Division	Calibration Points	Length (mm)	Immersion
61099-068	ASTM Mercury	77 to 131 °F	0.2 °F	5 calibration points (32, 80, 95, 115, 130 °F)	379	Total
15-61099-057	ASTM Mercury	25 to 55 °C	0.1 °C	5 calibration points (0, 25, 35, 45, 55 °C)	379	Total

Thermometers, Glass Non-mercury, Certified Precision

These thermometers are used as calibration standards in cold treatment, hot water dip treatment, and hot air treatment.

Thermometers from other sources may be considered, as long as they meet the specifications outlined in Chapter 8: [Equipment](#).

Request approval for thermometers from:

USDA-APHIS-PPQ-S&T-TMT
 13601 Old Cutler Road, Bldg. 63
 Miami, FL 33158 USA
 Phone: 305-278-4877
 Fax: 305-278-4898
 email: ppqmt@usda.gov

Cole-Parmer

625 East Bunker Court
 Vernon Hills, IL 60061

Table E-5 Cole-Parmer - Approved Thermometers

Catalog No.	Type	Range	Scale Division	Calibration Points	Length (mm)	Immersion
K-08007-15	Thermo-Scientific ERTCO®	77 to 131 °F	0.2 °F	5 calibration points (32, 80, 95, 115, 130 °F)	379	Total
K-08007-14	Thermo-Scientific ERTCO®	25 to 55 °C	0.1 °C	5 calibration points (0, 25, 35, 45, 55 °C)	379	Total
EW-08007-20	Thermo-Scientific ERTCO®	95 to 155 °C	0.2 °C	5 calibration points (0, 100, 110, 130, 150 °C)	379	100 mm

Thermometers, Digital, Certified Precision

These thermometers are used as a calibration standard and can be substituted for mercury and non-mercury thermometers in cold treatment, hot water dip treatment, and hot air treatment.

Thermometers from other sources may be considered, as long as they meet the specifications outlined in Chapter 8: [Equipment](#).

Request approval for thermometers from:

USDA-APHIS-PPQ-S&T-TMT
13601 Old Cutler Road, Bldg. 63
Miami, FL 33158 USA
Phone: 305-278-4877
Fax: 305-278-4898
email: ppqmt@usda.gov

Contech

Rafael G. De Avila Aceves
Miguel Galindo 2033, J. del Country
Guadalajara, Jalisco, Mexico, C.P. 44210

- ◆ Term 2252 thermometer; sensors SP20758-1 (see Measurement Specialties) and adapter Part #364-A for Oakton Acorn Temp 4) and sensors with YSI 400 series sensors (see Advanced Industrial Services, Inc. (AIS))

Eutech Instruments

For Africa, Asia, Middle East and Pacific Rim:

Eutech Instruments Pte Ltd.

Blk 55, Ayer Rajah Crescent, #04-16/24, Singapore 139949

For Europe:

Eutech Instruments Europe B.V.

P.O. Box 254, 3860 AG Nijkerk
The Netherlands

For North and South America:

Oakton Instruments

P.O. Box 5136
Vernon Hills, IL 60061

- ◆ Acorn® Temp 4 Meter (use 400 series thermistor probe; suggested general purpose probes are: Oakton air probe #WD-08491-08; Oakton penetration probe # WD-08491-16; Oakton general purpose probe 10, 50, or 100 feet #WD-08491-02, #WD-08491-04, #WD-08491-03; Oakton Acron Temp 5 #EW-35626-10))

Oakton products can be purchased at numerous distributors such as Cole-Parmer, Davis Instruments, etc.

Cole-Parmer

625 East Bunker Court

Vernon Hills, IL 60061

For China:

Thermo Fisher Scientific
Building 6, No. 27 Xin Jinqiao Road
Shanghai 201206, China

For India:

Thermo Fisher Scientific
102, 104 Delphi 'C' Wing
Hiranandani Business Park
Powai, Mumbai - 400 076

- ◆ **Catalog # 60010-85:** Digital thermometer with range -330 to 2210 °F or -201 to 1210 °C; Resolution 0.1 °C/°F at 100.0 to 999.9 C/F; Accuracy +/- 0.1 °C/°F at 100 to 999.9 °C/°F; various probe lengths. Request NIST traceable calibration with 5 temperature points or more and a certificate.

Fluke Corporation

6920 Seaway Boulevard
Everett, WA 98203

- ◆ **Model Name 1551A -9 to 20:** 1551A EX Thermometer, Fixed RTD, -50 °C to -160 °C (-58 °F to 320 °F), choice of sensor length can be 9, 12, and 20 inches; Accuracy +/- 0.05 °C. Includes NVLAP-accredited report of calibration; NIST traceable, User's guide on CD-ROM, 3 AAA batteries
- ◆ **Model Name 1552A -9 to 20:** 1552A EX Thermometer, Fixed RTD, -80 °C to 300 °C (-112 °F to 572 °F), Sensor length 12 inches; Accuracy +/- 0.05 °C; Includes NVLAP-accredited report of calibration; NIST traceable, User's guide on CD-ROM, 3 AAA batteries

OpticsPlanet, Inc.

3150 Commercial Avenue
Northbrook, IL 60062

- ◆ **Catalog #C1-LB-4000:** Control Company Digital Data Logger Thermometer with Probe 4000/61220-601; Accuracy +/- 0.05 °C; Request NIST calibration and certificate with 5 or more temperature points in treatment range.

Palmer Wahl Instrumentation Group

234 Old Weaverville Road
Asheville, NC 28804-1228

- ◆ **Model DST600 Series:** Precision hand-held reference thermometer; Range -50 °F to 500 °F; Accuracy +/- 0.1 °C/°F over a 1 year period; with certificate of calibration. Request NIST calibration and certificate with temperature points in treatment range; choice of temperature sensors.

Tech Instrumentation, Inc.

750 E. Kiowa Avenue
P.O. Box 2029
Elizabeth, CO 80107

- ◆ **Catalog #TL-1W:** Digital thermometer with range -44 °F to 600 °F and -43 °C to 315 °C; Resolution 0.01 degrees; Accuracy +/- 0.1 F below 300 °F; Various stem lengths; 4 point NIST traceable calibration included; 1 year warranty.

Thermco Products, Inc.

10 Millpond Drive
Lafayette, NJ 07848

- ◆ **Catalog #ACCD650P:** High Precision Digital Pt100 Platinum Thermometer; Range Pt100: -200 °C to +850 °C: Accuracy Pt100 +/- 0.03 from -50 °C to +199.99 °C; with certificate of calibration. Request NIST calibration and certificate with 5 or more temperature points in treatment range; ACCD1019 High Precision Probe Pt100 Platinum 12” (405 mm)

Thermoprobe, Inc.

112-A Jetport Drive
Pearl, MS 39208

- ◆ **Catalog #TL-1W:** Digital thermometer with range -44 °F to 600 °F and -43 °C to 315 °C; Resolution 0.01 degrees; Accuracy +/- 0.1 F below 300 °F; Various stem lengths; 4 point NIST traceable calibration included; 1 year warranty.

ThermoWorks

1762 W. 20 S., #100
Lindon, UT 84042

- ◆ **Model P600 Series:** Precision hand-held reference thermometer: Range -328 °F to 842 °F; Accuracy 0.05 °F from -148 to 302 °F; with certificate of calibration. Request NIST calibration and certificate with temperature points in treatment range; choice of temperature sensors.

Thermometers, Certified Precision, Approved Calibration Companies

Conduct thermometer calibration by USDA-approved calibration companies. Follow the procedures for calibration summarized in [Equipment](#).

DC Scientific Glass

Mail. P.O. Box 1099
Pasadena, MD 21123
Physical Location: 510 McCormick Drive, Suite D
Hanover, MD 21076

Barnstead International

(sold as Thermo Scientific brand)
2555 Kerper Boulevard
Dubuque, IA 52001

Fluke Corporation

6920 Seaway Boulevard
Everett, WA 98203

ICL Calibration Laboratories, Inc.

1501 Decker Avenue, Suite 118
Stuart, FL 34994

- ◆ Calibration, repair, and adjustment of the Thermoprobe TL-1W

INNOCAL

625 East Bunker Court M/S 14
Vernon Hills, IL 60061-1844

Instrumentation Technical Services

20 Hagerty Boulevard, Suite 1
West Chester, PA 19382

Measurement Assurance Technology

1600 Corporate Court, Suite 150
Irving, TX 75038

Phoenix Calibration DR

Calle 8, No. 9
Rosmil Residential
Santo Domingo, Dominican Republic

Thermoprobe, Inc.

112-A Jetport Drive
Pearl, MS 39208

VWR

Radnor Corporate Center
Building One, Suite 200
P.O. Box 6660
100 Matsonford Road
Radnor, PA 19087-8660

Thermometers, Recorders, and Sensors—General Use

CAS Datalogger

12628 Chillicothe Road, Unit J
Chesterland, OH 44026

- ◆ dataTaker DT-85, Delphin Expert Logger Models 100, 200, 300

Cole-Parmer

625 East Bunker Court
Vernon Hills, IL 60061

Contech

Rafael G. De Avila Aceves
Miguel Galindo 2033, J. del Country
Guadalajara, Jalisco, Mexico, C.P. 44210

- ◆ Term 2252 thermometer; sensors SP20758-1 (see Measurement Specialties) and adapter Part #364-A for Oakton Acorn Temp 4) and sensors with YSI 400 series sensors (see Advanced Industrial Services, Inc. (AIS)))

GEC Instruments

5530 NW 97th Street
Gainesville, FL 32653

- ◆ Model S16TC Type T Thermocouple
- ◆ Model S4TC Type T Thermocouple

MadgeTech, Inc.

6 Warner Road
Warner, NH 03278

- ◆ Model HITEMP 150A

Mesa Laboratories, Inc.

Data Trace Division
12100 West 6th Avenue

- ◆ Models: Data Tracers, STO, LTO, and Micropack III

Nanmac Corporation

11 Mayhew Street
Framingham, MA 01702

National Instruments Corporation

11500 N. Mopac Expressway
Austin, TX 78759-3504

Nordic Sensors Industrial, Inc. (NSI)

1350 rue Nationale

Terrebonne, Quebec
Canada J6W 6M1

Omega Engineering, Inc.
P.O. Box 4047
One Omega Drive
Stamford, CT 06907-0047

Tubing, Gas-Sampling

(polyethylene or polypropylene)

Cole-Parmer
625 East Bunker Court
Vernon Hills, IL 60061

Consolidated Plastics Co. Inc.
4700 Prosper Drive
Stow, OH 44224

Fisher Scientific
2000 Park Lane Drive
Pittsburgh, PA 15275

Thomas Scientific
P.O. Box 99
99 High Hill Road at I-295
Swedesboro, NJ 08085-0099

Vacuum Pump

Air compressor for use with vacuum fumigation chambers.

Neward Enterprises, Inc.
Distributor: McMaster-Carr
P.O. Box 740100
Atlanta, GA 30374-0100

◆ Product: Mityvac® hand-held vacuum pump. Zinc-alloy pump #9963K12

Sargent Welch
P.O. Box 4130
Buffalo, NY 14217

Vapam

(see [Metam-Sodium](#))

Vapor Heat/Forced Hot Air (VH/FHA) Chamber Manufacturers

Quarantine Technologies International
463 Frankton Road
Queenstown, New Zealand

- ◆ Forced Hot Air Model: Wide Body

FoodPro International, Inc. (FHA)
P.O. Box 53110
San Jose, CA, 95153-0110

- ◆ Forced Hot Air Model 5S-VID-CS

Sanshu Sangyo Co., LTD.
11-2, Nanei 4-chome
Kagoshima 891-01 Japan

- ◆ Model EHK-600P; EHK-1000P

Vapor Heat/Forced Hot Air (VH/FHA) Recorders

CHINO Works America, Inc.

Los Angeles Office
22301 S. Western Ave.
Suite 105
Torrance, CA 90501

Chicago Office
121 S. Wilke Rd.
Suite 226
Arlington Heights, IL. 60005

- ◆ Product: Model LE5100 Hybrid recorder LE5200; LE11733RNI; AA series;
- ◆ LE5133-111; AA-03-NRA

Contech

Rafael G. De Avila Aceves
Miguel Galindo 2033, J. del Country
Guadalajara, Jalisco, Mexico, C.P. 44210

- ◆ Product: Contech monitoring and distributed control system with Smart Seda to operate up to six forced air chambers.

Leeds & Northrup Instruments

615 E. Carson Street
Pittsburg, PA 15203-1021

- ◆ Product: Micromax® Process Management Center 1986

OMEGA Engineering, INC.

800 Connecticut Ave.
Suite, 5N01
Norwalk, CT 06854

- ◆ Product: OM6 data products recorder

Volatilizer

(for volatilizing liquid methyl bromide into a fumigant gas)

Degesch America, Inc.

Houston Division
P.O. Box 451036
Houston, TX 77245

Vacudyne, Inc.

375 East Joe Orr Road
Chicago Heights, IL 60411

Warning Signs and Placards

Carlton Industries, L.P.
P.O. Box 280
La Grange, TX 78945

Champion America
P.O. Box 3092
Stony Creek, CT 06405

Appendix F

EPA Crop Groups

Contents

Crop Group 1: Root and Tuber	F-2
Crop Group 2: Leaves of Root and Tuber Vegetables	F-3
Crop Group 3: Bulb Vegetable (Allium spp.)	F-4
Crop Group 4: Leafy Vegetables (except Brassica vegetables)	F-5
Crop Group 5: Brassica (Cole) Leafy Vegetables	F-6
Crop Group 6: Legume Vegetables (succulent or dried)	F-7
Crop Group 7: Leaves of Legume Vegetables	F-8
Crop Group 8: Fruiting Vegetables	F-9
Crop Group 9: Cucurbit Vegetables	F-10
Crop Group 10: Citrus Fruit	F-11
Crop Group 11: Pome Fruit	F-12
Crop Group 12: Stone Fruit	F-13
Crop Group 13: Berries and Small Fruit	F-14
Crop Group 14: Tree Nuts	F-16
Crop Group 15: Cereal Grains	F-17
Crop Group 16: Forage, Fodder, and Straw of Cereal Grains	F-18
Crop Group 17: Grass, Forage, Fodder, and Hay	F-19
Crop Group 18: Nongrass Animal Feeds (Forage, Fodder, Straw, and Hay)	F-20
Crop Group 19: Herbs and Spices	F-21
Crop Group 20: Oilseed	F-23
Crop Group 21: Edible Fungi	F-24
Crop Group 22: Stalk, Stem, and Leaf Petiole Vegetables	F-25
Crop Group 23: Tropical and Subtropical Fruit, Edible Peels	F-26
Crop Group 24: Tropical and Subtropical Fruit, Inedible Peels	F-30

Introduction

The EPA requires chemical tolerances for residue data on raw agricultural commodities intended for human or animal consumption.

This Appendix lists the individual commodities in each crop group and is intended as a quick reference for the reader. These tables are updated annually and may not reflect the current crop groups in the [EPA Crop Group tables \(CFR 40 180.41\)](#). Refer to the EPA Crop Group tables for the most recent information. All commodities included in the EPA sub-groups of each EPA crop group are also eligible for the FIFRA Section 18 exemption fumigation.

Crop Group 1: Root and Tuber

Table F-1 Crop Group 1: Root and Tuber

Arracacha (<i>Arracacia xanthorrhiza</i>)
Arrowroot (<i>Maranta arundinacea</i>)
Artichoke, Chinese (<i>Stachys affinis</i>)
Artichoke, Jerusalem (<i>Helianthus tuberosus</i>)
Beet, garden (<i>Beta vulgaris</i>)
Beet, sugar (<i>Beta vulgaris</i>)
Burdock, edible (<i>Arctium lappa</i>)
Canna, edible (Queensland arrowroot) (<i>Canna indica</i>)
Carrot (<i>Daucus carota</i>)
Cassava, bitter and sweet (<i>Manihot esculenta</i>)
Celeriac (celery root) (<i>Apium graveolens</i> var. <i>rapaceum</i>)
Chayote (root) (<i>Sechium edule</i>)
Chervil, turnip-rooted (<i>Chaerophyllum bulbosum</i>)
Chicory (<i>Cichorium intybus</i>)
Chufa (<i>Cyperus esculentus</i>)
Dasheen (taro) (<i>Colocasia esculenta</i>)
Ginger (<i>Zingiber officinale</i>)
Ginseng (<i>Panax quinquefolius</i>)
Horseradish (<i>Armoracia rusticana</i>)
Leren (<i>Calathea allouia</i>)
Parsley, turnip-rooted (<i>Petroselinum crispum</i> var. <i>tuberosum</i>)
Parsnip (<i>Pastinaca sativa</i>)
Potato (<i>Solanum tuberosum</i>)
Radish (<i>Raphanus sativus</i>)
Radish, oriental (daikon) (<i>Raphanus sativus</i> subvar. <i>longipinnatus</i>)
Rutabaga (<i>Brassica campestris</i> var. <i>napobrassica</i>)
Salsify (oyster plant) (<i>Tragopogon porrifolius</i>)
Salsify, black (<i>Scorzonera hispanica</i>)
Salsify, Spanish (<i>Scolymus hispanicus</i>)
Skirret (<i>Sium sisarum</i>)
Sweet potato (<i>Ipomoea batatas</i>)
Tanier (cocoyam) (<i>Xanthosoma sagittifolium</i>)
Turmeric (<i>Curcuma longa</i>)
Turnip (<i>Brassica rapa</i> var. <i>rapa</i>)
Yam bean (jicama, manoic pea) (<i>Pachyrhizus</i> spp.)
Yam, true (<i>Dioscorea</i> spp.)

Crop Group 2: Leaves of Root and Tuber Vegetables

Table F-2 Crop Group 2: Leaves of Root and Tuber Vegetables

Beet, garden (<i>Beta vulgaris</i>)
Beet, sugar (<i>Beta vulgaris</i>)
Burdock, edible (<i>Arctium lappa</i>)
Carrot (<i>Daucus carota</i>)
Cassava, bitter and sweet (<i>Manihot esculenta</i>)
Celeriac (celery root) (<i>Apium graveolens</i> var. <i>rapaceum</i>)
Chervil, turnip-rooted (<i>Chaerophyllum bulbosum</i>)
Chicory (<i>Cichorium intybus</i>)
Dasheen (taro) (<i>Colocasia esculenta</i>)
Parsnip (<i>Pastinaca sativa</i>)
Radish (<i>Raphanus sativus</i>)
Radish, oriental (daikon) (<i>Raphanus sativus</i> subvar. <i>longipinnatus</i>)
Rutabaga (<i>Brassica campestris</i> var. <i>napobrassica</i>)
Salsify, black (<i>Scorzonera hispanica</i>)

Crop Group 3: Bulb Vegetable (*Allium* spp.)

Table F-3 Crop Group 3: Bulb Vegetable (*Allium* spp.)

Chive, fresh leaves (<i>Allium schoenoprasum</i> L.)
Chive, Chinese, fresh leaves (<i>Allium tuberosum</i> Rottler ex Spreng)
Daylily, bulb (<i>Heimerocallis fulva</i> (L.) L. var. <i>fulva</i>)
Elegans hosta (<i>Hosta sieboldiana</i> (Hook.) Engl)
Fritillaria, bulb (<i>Fritillaria</i> L. <i>fritillary</i>)
Fritillaria, leaves (<i>Fritillaria</i> L. <i>fritillary</i>)
Garlic, bulb (<i>Allium sativum</i>)
Garlic, bulb (<i>Allium sativum</i> L. var. <i>sativum</i>) (<i>A. sativum</i> Common Garlic Group)
Garlic, great headed, bulb (<i>Allium ampeloprasum</i> L. var. <i>ampeloprasum</i>) (<i>A. ampeloprasum</i> Great Headed Garlic Group)
Garlic, great headed (elephant) (<i>Allium ampeloprasum</i> var. <i>ampeloprasum</i>)
Garlic, Serpent, bulb (<i>Allium sativum</i> var. <i>ophioscorodon</i> or <i>A. sativum</i> Ophioscorodon Group)
Kurrat (<i>Allium kurrat</i> Schweinf. Ex. K. Krause or <i>A. ampeloprasum</i> Kurrat Group)
Lady's leek (<i>Allium cernuum</i> Roth)
Leek (<i>Allium ampeloprasum</i> , <i>A. porrum</i> , <i>A. tricoccum</i>)
Leek <i>Allium porrum</i> L. (syn: <i>A. ampeloprasum</i> L. var. <i>porrum</i> (L.) J. Gay) (<i>A. ampeloprasum</i> Leek Group)
Leek, wild (<i>Allium tricoccum</i> Aiton)
Lily, bulb (<i>Lilium</i> spp. (<i>Lilium Leichtlinii</i> var. <i>maximowiczii</i> , <i>Lilium lancifolium</i>)
Onion, Beltsville bunching (<i>Allium x proliferum</i> (Moench) Schard.) (syn: <i>Allium fistulosum</i> L. x <i>A. cepa</i> L.)
Onion, Chinese, bulb (<i>Allium chinense</i> G. Don.) (syn: <i>A. bakeri</i> Regel)
Onion, dry bulb and green (<i>Allium cepa</i> , <i>A. fistulosum</i>)
Onion, fresh (<i>Allium fistulosum</i> L. var. <i>caespitosum</i> Makino)
Onion, green (<i>Allium cepa</i> L. var. <i>cepa</i>) (<i>A. cepa</i> Common Onion Group)
Onion, macrostem (<i>Allium macrostemom</i>) Bunge
Onion, pearl (<i>Allium porrum</i> var. <i>sectivum</i> or <i>A. ampeloprasum</i> Pearl Onion Group)
Onion, potato, bulb (<i>Allium cepa</i> L. var. <i>aggregatum</i> G. Don.) (<i>A. cepa</i> Aggregatum Group)
Onion, tree, tops (<i>Allium x proliferum</i> (Moench) Schrad. ex Willd.) (syn: <i>A. cepa</i> var. <i>proliferum</i> (Moench) Regel; <i>A. cepa</i> L. var. <i>bulbiferum</i> L.H. Bailey; <i>A. cepa</i> L. var. <i>viviparum</i> (Metz.) Alef.)
Onion, Welsh (<i>Allium fistulosum</i>)
Onion, Welsh, tops (<i>Allium fistulosum</i> L.)
Shallot (<i>Allium cepa</i> var. <i>cepa</i>)
Shallot, bulb (<i>Allium cepa</i> var. <i>aggregatum</i> G. Don.)
Shallot, fresh leaves (<i>Allium cepa</i> var. <i>aggregatum</i> G. Don.)
Cultivars, varieties, and/or hybrids of these.

Crop Group 4: Leafy Vegetables (except *Brassica* vegetables)

Table F-4 Crop Group 4: Leafy Vegetables (except *Brassica* vegetables)

Amaranth (leafy amaranth, Chinese spinach, tampala) (<i>Amaranthus</i> spp.)
Arugula (Roquette) (<i>Eruca sativa</i>)
Cardoon (<i>Cynara cardunculus</i>)
Celery (<i>Apium graveolens</i> var. <i>dulce</i>)
Celery, Chinese (<i>Apium graveolens</i> var. <i>secalinum</i>)
Celtuce (<i>Lactuca sativa</i> var. <i>angustana</i>)
Chervil (<i>Anthriscus cerefolium</i>)
Chrysanthemum, edible-leaved (<i>Chrysanthemum coronarium</i> var. <i>coronarium</i>)
Chrysanthemum, garland (<i>Chrysanthemum coronarium</i> var. <i>spatiosum</i>)
Corn salad (<i>Valerianella locusta</i>)
Cress, garden (<i>Lepidium sativum</i>)
Cress, upland (yellow rocket, winter cress) (<i>Barbarea vulgaris</i>)
Dandelion (<i>Taraxacum officinale</i>)
Dock (sorrel) (<i>Rumex</i> spp.)
Endive (escarole) (<i>Cichorium endivia</i>)
Fennel, Florence (finocchio) (<i>Foeniculum vulgare</i> Azoricum Group)
Lettuce, head and leaf (<i>Lactuca sativa</i>)
Orach (<i>Atriplex hortensis</i>)
Parsley (<i>Petroselinum crispum</i>)
Purslane, garden (<i>Portulaca oleracea</i>)
Purslane, winter (<i>Montia perfoliata</i>)
Radicchio (red chicory) (<i>Cichorium intybus</i>)
Rhubarb (<i>Rheum rhabarbarum</i>)
Spinach (<i>Spinacia oleracea</i>)
Spinach, New Zealand (<i>Tetragonia tetragonioides</i> , <i>T. expansa</i>)
Spinach, vine (Malabar spinach, Indian spinach) (<i>Basella alba</i>)
Swiss chard (<i>Beta vulgaris</i> var. <i>cicla</i>)

Crop Group 5: *Brassica* (Cole) Leafy Vegetables

Table F-5 Crop Group 5: *Brassica* (Cole) Leafy Vegetables

Broccoli (<i>Brassica oleracea</i> var. <i>botrytis</i>)
Broccoli, Chinese (gai lon) (<i>Brassica alboglabra</i>)
Broccoli raab (rapini) (<i>Brassica campestris</i>)
Brussels sprouts (<i>Brassica oleracea</i> var. <i>gemmifera</i>)
Cabbage (<i>Brassica oleracea</i>)
Cabbage, Chinese (bok choy) (<i>Brassica chinensis</i>)
Cabbage, Chinese (napa) (<i>Brassica pekinensis</i>)
Cabbage, Chinese mustard (gai choy) (<i>Brassica campestris</i>)
Cauliflower (<i>Brassica oleracea</i> var. <i>botrytis</i>)
Cavalo broccolo (<i>Brassica oleracea</i> var. <i>botrytis</i>)
Collards (<i>Brassica oleracea</i> var. <i>acephala</i>)
Kale (<i>Brassica oleracea</i> var. <i>acephala</i>)
Kohlrabi (<i>Brassica oleracea</i> var. <i>gongylodes</i>)
Mizuna (<i>Brassica rapa</i> Japonica Group)
Mustard Greens (<i>Brassica juncea</i>)
Mustard spinach (<i>Brassica rapa</i> Perviridis Group)
Rape greens (<i>Brassica napus</i>)

Crop Group 6: Legume Vegetables (succulent or dried)

Table F-6 Crop Group 6: Legume Vegetables (succulent or dried)

Bean (<i>Lupinus</i> spp.) (includes grain lupin, sweet lupin, white lupin, and white sweet lupin)
Bean (<i>Phaseolus</i> spp.) (includes field bean, kidney bean, lima bean, navy bean, pinto bean, runner bean, snap bean, tepary bean, wax bean)
Bean (<i>Vigna</i> spp.) (includes adzuki bean, asparagus bean, blackeyed pea, catjang, Chinese longbean, cowpea, Crowder pea, moth bean, mung bean, rice bean, southern pea, urd bean yardlong bean)
Broad bean (fava bean) (<i>Vicia faba</i>)
Chickpea (garbanzo bean) (<i>Cicer arietinum</i>)
Guar (<i>Cyamopsis tetragonoloba</i>)
Jackbean (<i>Canavalia ensiformis</i>)
Lablab bean (hyacinth bean) (<i>Lablab purpureus</i>)
Lentil (<i>Lens esculenta</i>)
Pea (<i>Pisum</i> spp.) (includes dwarf pea, edible-pod pea, English pea, field pea, garden pea, green pea, snow pea, sugar snap pea)
Pigeon pea (<i>Cajanus cajan</i>)
Soybean (<i>Glycine max</i>)
Soybean (immature seed) (<i>Glycine max</i>)
Sword bean (<i>Canavalia gladiata</i>)

Crop Group 7: Leaves of Legume Vegetables

Table F-7 Crop Group 7: Leaves of Legume Vegetables

Any cultivar of bean (<i>Phaseolus</i> spp.), field pea (<i>Pisum</i> spp.), and soybean (<i>Glycine max</i>). Plant parts of any legume vegetable included in the legume vegetables that will be used as animal feed.

Crop Group 8: Fruiting Vegetables

Table F-8 Crop Group 8: Fruiting Vegetables

African eggplant (<i>Solanum macrocarpon</i> L.)
Bush tomato (<i>Solanum centrale</i> J.M. BlackCocona, <i>Solanum sessiliflorum</i> Dunal)
Currant tomato (<i>Lycopersicon pimpinellifolium</i>)
Eggplant (<i>Solanum melongena</i> L.)
Garden huckleberry (<i>Solanum scabrum</i> Mill)
Goji berry (<i>Lycium barbarum</i>)
Groundcherry (<i>Physalis alkekengi</i> L., <i>P. grisea</i> (Waterf.) M. Martinez, <i>P. peruviana</i> L., <i>P. pubescens</i>)
Martynia (<i>Proboscidea louisianica</i> (Mill.) Thell)
Naranjilla (<i>Solanum quitoense</i> Lam)
Okra (<i>Abelmoschus esculentus</i> (L.) Moench)
Pea eggplant (<i>Solanum torvum</i> Sw.)
Pepino (<i>Solanum muricatum</i> Aiton)
Pepper, bell (<i>Capsicum annuum</i> L. var. <i>annuum</i> , <i>Capsicum</i> spp.)
Pepper, nonbell (<i>Capsicum chinense</i> Jacq., <i>C. annuum</i> L. var. <i>annuum</i> , <i>C. frutescens</i> L., <i>C. baccatum</i> L., <i>C. pubescens</i> Ruiz & Pav., <i>Capsicum</i> spp.)
Roselle (<i>Hibiscus sabdariffa</i> L.)
Scarlet eggplant (<i>Solanum aethiopicum</i> L.)
Sunberry (<i>Solanum retroflexum</i> Dunal)
Tomatillo (<i>Physalis philadelphica</i> Lam)
Tomato (<i>Solanum lycopersicum</i> L., <i>Solanum lycopersicum</i> L. var. <i>lycopersicum</i>)
Tree tomato (<i>Solanum betaceum</i> Cav)
Cultivars, varieties, and/or hybrids of these

Crop Group 9: Cucurbit Vegetables

Table F-9 Crop Group 9: Cucurbit Vegetables

Chayote (fruit) (<i>Sechium edule</i>)
Chinese waxgourd (Chinese preserving melon) (<i>Benincasa hispida</i>)
Citron melon (<i>Citrullus lanatus</i> var. <i>citroides</i>)
Cucumber (<i>Cucumis sativus</i>)
Gherkin (<i>Cucumis anguria</i>)
Gourd, edible (<i>Lagenaria</i> spp.) (includes hyotan, cucuzza); (<i>Luffa acutangula</i> , <i>L. cylindrica</i>) (includes hechima, Chinese okra)
<i>Momordica</i> spp. (includes balsam apple, balsam pear, bitter melon, Chinese cucumber)
Muskmelon (hybrids and/or cultivars of <i>Cucumis melo</i>) (includes true cantaloupe, cantaloupe, casaba, crenshaw melon, golden pershaw melon, honeydew melon, honey balls, mango melon, Persian melon, pineapple melon, Santa Claus melon, and snake melon)
Pumpkin (<i>Cucurbita</i> spp.)
Squash, summer (<i>Cucurbita pepo</i> var. <i>melopepo</i>) (includes crookneck squash, scallop squash, straightneck squash, vegetable marrow, zucchini)
Squash, winter (<i>Cucurbita maxima</i> ; <i>C. moschata</i>) (includes butternut squash, calabaza, hubbard squash); (<i>C. mixta</i> ; <i>C. pepo</i>) (includes acorn squash, spaghetti squash)
Watermelon (includes hybrids and/or varieties of <i>Citrullus lanatus</i>)

Crop Group 10: Citrus Fruit

Table F-10 Crop Group 10: Citrus Fruit

Australian desert lime (<i>Eremocitrus glauca</i> (Lindl.) Swingle)
Australian finger lime (<i>Microcitrus australasica</i> (F. Muell.) Swingle)
Australian round lime (<i>Microcitrus australis</i> (A. cunn. Ex Mudie) Swingle)
Brown River finger lime (<i>Microcitrus papuana</i> Winters)
Calamondin (<i>Citrofortunella microcarpa</i> (Bunge) Wijnands)
Citron (<i>Citrus medica</i> L.)
Citrus hybrids (<i>Citrus</i> spp., <i>Eremocitrus</i> spp., <i>Fortunella</i> spp., <i>Microcitrus</i> spp., and <i>Poncirus</i> spp.)
Grapefruit (<i>Citrus paradisi</i> Macfad)
Japanese summer grapefruit (<i>Citrus natsudaidai</i> Hayata)
Kumquat (<i>Fortunella</i> spp.)
Lemon (<i>Citrus limon</i> (L.) Burm. f.)
Lime (<i>Citrus aurantiifolia</i> (Christm.) Swingle)
Mediterranean mandarin (<i>Citrus deliciosa</i> Ten)
Mount White lime (<i>Microcitrus garrowayae</i> (F.M. Bailey) Swingle)
New Guinea wild lime (<i>Microcitrus warburgiana</i> (F.M. Bailey) Tanaka)
Orange, sour (<i>Citrus aurantium</i> L.)
Orange, sweet (<i>Citrus sinensis</i> (L.) Osbeck)
Pummelo (<i>Citrus maxima</i> (Burm.) Merr)
Russell River lime (<i>Microcitrus inodora</i> (F.M. Bailey) Swingle)
Satsuma mandarin (<i>Citrus unshiu</i> Marcow)
Sweet lime (<i>Citrus limetta</i> Risso)
Tachibana orange (<i>Citrus tachibana</i> (Makino) Tanaka)
Tahiti lime (<i>Citrus latifolia</i> (Yu. Tanaka) Tanaka)
Tangelo (<i>Citrus x tangelo</i> J.W. Ingram & H.E. Moore)
Tangerine (Mandarin) (<i>Citrus reticulata</i> Blanco)
Tangor (<i>Citrus nobilis</i> Lour)
Trifoliolate orange (<i>Poncirus trifoliata</i> (L.) Raf.)
Uniq fruit (<i>Citrus aurantium</i> Tangelo Group)
Cultivars, varieties, and/or hybrids of these

Crop Group 11: Pome Fruit

Table F-11 Crop Group 11: Pome Fruit

Apple (<i>Malus domestica</i> Borkh.)
Azarole (<i>Crataegus azarolus</i> L.)
Crabapple (<i>Malus sylvestris</i> (L.) Mill., <i>M. prunifolia</i> (Willd.) Borkh.)
Loquat (<i>Eriobotrya japonica</i> (Thunb.) Lindl.)
Mayhaw (<i>Crataegus aestivalis</i> (Walter) Torr. & A. Gray, <i>C. opaca</i> Hook. & Arn., and <i>C. rufula</i> Sarg.)
Medlar (<i>Mespilus germanica</i> L.)
Pear (<i>Pyrus communis</i> L.)
Pear, Asian (<i>Pyrus pyrifolia</i> (Burm. f.) Nakai var. <i>culta</i> (Makino) Nakai)
Quince (<i>Cydonia oblonga</i> Mill.)
Quince, Chinese (<i>Chaenomeles speciosa</i> (Sweet) Nakai, <i>Pseudocydonia sinensis</i> (Thouin) C.K. Schneid.)
Quince, Japanese (<i>Chaenomeles japonica</i> (Thunb.) Lindl. ex Spach)
Tejocote (<i>Crataegus mexicana</i> DC.)
Cultivars, varieties, and/or hybrids of these

Crop Group 12: Stone Fruit

Table F-12 Crop Group 12: Stone Fruit

Apricot (<i>Prunus armeniaca</i>)
Apricot, Japanese (<i>Prunus mume</i>)
Capulin (<i>Prunus serotina</i>)
Cherry, black (<i>Prunus serotina</i>)
Cherry, Nanking (<i>Prunus tomentosa</i>)
Cherry, sweet (<i>Prunus avium</i>)
Cherry, tart (<i>Prunus cerasus</i>)
Jujube, Chinese (<i>Ziziphus jujuba</i>)
Nectarine (<i>Prunus persica</i>)
Peach (<i>Prunus persica</i>)
Plum (<i>Prunus domestica</i> , <i>Prunus</i> spp.)
Plum, American (<i>Prunus americana</i>)
Plum, beach (<i>Prunus maritima</i>)
Plum, Canada (<i>Prunus nigra</i>)
Plum, cherry (<i>Prunus cerasifera</i>)
Plum, Chickasaw (<i>Prunus angustifolia</i>)
Plum, Damson (<i>Prunus domestica</i> spp. <i>insititia</i>)
Plum, Japanese (<i>Prunus salicina</i>)
Plum, Klamath (<i>Prunus subcordata</i>)
Plum, prune (<i>Prunus domestica</i> L. subsp. <i>domestica</i>)
Plumcot (<i>Prunus</i> hybr.)
Sloe (<i>Prunus spinosa</i> L.)
Cultivars, varieties, and/or hybrids of these

Crop Group 13: Berries and Small Fruit

Table F-13 Crop Group 13: Berries and Small Fruit

Amur river grape (<i>Vitis amurensis</i> Rupr)
Aronia berry (<i>Aronia</i> spp.)
Bayberry (<i>Myrica</i> spp.)
Bearberry (<i>Arctostaphylos uva-ursi</i>)
Bilberry (<i>Vaccinium myrtillus</i> L.)
Blackberry (<i>Rubus</i> spp.) (including Andean blackberry, arctic blackberry, bingleberry, black satin berry, boysenberry, brombeere, California blackberry, Chesterberry, Cherokee blackberry, Cheyenne blackberry, common blackberry, coryberry, darrowberry, dewberry, Dirksen thornless berry, evergreen blackberry, Himalayaberry, hullberry, lavacaberry, loganberry, lowberry, Lucretiaberry, mammoth blackberry, marionberry, mora, mures deronce, nectarberry, Northern dewberry, olallieberry, Oregon evergreen berry, phenomenalberry, rangeberry, rossberry, Shawnee blackberry, Southern dewberry, tayberry, youngberry, zarzamora, and cultivars, varieties, and/or hybrids of these)
Blueberry, highbush (<i>Vaccinium</i> spp.)
Blueberry, lowbush (<i>Vaccinium angustifolium</i> Aiton)
Buffalo currant (<i>Ribes aureum</i> Pursh)
Buffaloberry (<i>Shepherdia argentea</i> (Pursh) Nutt.)
Che (<i>Cudrania tricuspidata</i> Bur. Ex Lavallee)
Chilean guava (<i>Myrtus ugni</i> Mol.)
Chokecherry (<i>Prunus virginiana</i> L.)
Cloudberry (<i>Rubus chamaemorus</i> L.)
Cranberry (<i>Vaccinium macrocarpon</i> Aiton)
Currant, black (<i>Ribes nigrum</i> L.)
Currant, red (<i>Ribes rubrum</i> L.)
Elderberry (<i>Sambucus</i> spp.)
European barberry (<i>Berberis vulgaris</i> L.)
Gooseberry (<i>Ribes</i> spp.)
Grape (<i>Vitis</i> spp.)
Highbush cranberry (<i>Viburnum opulus</i> L. var. <i>Americanum</i> Aiton)
Honeysuckle, edible (<i>Lonicera caerulea</i> L. var. <i>emphylocalyx</i> Nakai, <i>Lonicera caerulea</i> L. var. <i>edulis</i> Turcz. ex herder)
Huckleberry (<i>Gaylussacia</i> spp.)
Jostaberry (<i>Ribes x nidigrolaria</i> Rud. Bauer and A. Bauer)
Juneberry (Saskatoon berry) (<i>Amelanchier</i> spp.)
Kiwifruit, fuzzy (<i>Actinidia deliciosa</i> A. Chev.) (C.F. Liang and A.R. Fergusons, <i>Actinidia chinensis</i> Planch.)
Kiwifruit, hardy (<i>Actinidia arguta</i> (Siebold and Zucc.) Planch. ex Miq)

Table F-13 Crop Group 13: Berries and Small Fruit (continued)

Lingonberry (<i>Vaccinium vitis-idaea</i> L.)
Maypop (<i>Passiflora incarnata</i> L.)
Mountain pepper berries (<i>Tasmannia lanceolata</i>) (Poir.) A.C. Sm.
Mulberry (<i>Morus</i> spp.)
Muntries (<i>Kunzea pomifera</i> F. Muell.)
Native currant (<i>Acrotriche depressa</i> R. BR.)
Partridgeberry (<i>Mitchella repens</i> L.)
Phalsa (<i>Grewia subinaequalis</i> DC.)
Pincherry (<i>Prunus pennsylvanica</i> L.f.)
Raspberry, black and red (<i>Rubus</i> spp.)
Riberry (<i>Syzygium luehmannii</i>)
Salal (<i>Gaultheria shallon</i> Pursh.)
Schisandra berry (<i>Schisandra chinensis</i> (Turcz.) Baill.)
Sea buckthorn (<i>Hippophae rhamnoides</i> L.)
Serviceberry (<i>Sorbus</i> spp.)
Strawberry (<i>Fragaria x ananassa</i> Duchesne)
Wild raspberry (<i>Rubus muelleri</i> Lefevre ex. P.J. Mull)
Cultivars, varieties, and/or hybrids of these

Crop Group 14: Tree Nuts

Table F-14 Crop Group 14: Tree Nuts

Almond (<i>Prunus dulcis</i>)
Beech nut (<i>Fagus</i> spp.)
Brazil nut (<i>Bertholletia excelsa</i>)
Butternut (<i>Juglans cinerea</i>)
Cashew (<i>Anacardium occidentale</i>)
Chestnut (<i>Castanea</i> spp.)
Chinquapin (<i>Castanea pumila</i>)
Filbert (hazelnut) (<i>Corylus</i> spp.)
Hickory nut (<i>Carya</i> spp.)
Macadamia nut (bush nut) (<i>Macadamia</i> spp.)
Pecan (<i>Carya illinoensis</i>)
Walnut, black and English (Persian) (<i>Juglans</i> spp.)

Crop Group 15: Cereal Grains

Table F-15 Crop Group 15: Cereal Grains

Barley (<i>Hordeum</i> spp.)
Buckwheat (<i>Fagopyrum esculentum</i>)
Corn (<i>Zea mays</i>)
Millet, pearl (<i>Pennisetum glaucum</i>)
Millet, proso (<i>Panicum milliaceum</i>)
Oats (<i>Avena</i> spp.)
Popcorn (<i>Zea mays</i> var. <i>everta</i>)
Rice (<i>Oryza sativa</i>)
Rye (<i>Secale cereale</i>)
Sorghum (milo) (<i>Sorghum</i> spp.)
Teosinte (<i>Euchlaena mexicana</i>)
Triticale (<i>Triticum-Secale</i> hybrids)
Wheat (<i>Triticum</i> spp.)
Wild rice (<i>Zizania aquatica</i>)

Crop Group 16: Forage, Fodder, and Straw of Cereal Grains

Table F-16 Crop Group 16: Forage, Fodder, and Straw of Cereal Grains

Crop Group 16 includes forage, fodder, stover, and straw of all commodities included in corn, wheat, and the cereal grains group.

Crop Group 17: Grass, Forage, Fodder, and Hay

Table F-17 Crop Group 17: Grass, Forage, Fodder, and Hay

The commodities included in Crop Group 17 are forage, fodder, stover, and hay of any grass, Gramineae/Poaceae family (either green or cured) **except** sugarcane, and those included in the cereal grains group, that will be fed to or grazed by livestock, all pasture and range grasses and grasses grown for hay or silage (e.g. grass forage, fodder, and hay of Bermuda grass, bluegrass, bromegrass, and fescue.)

Crop Group 18: Nongrass Animal Feeds (Forage, Fodder, Straw, and Hay)

Table F-18 Crop Group 18: Nongrass Animal Feeds (Forage, Fodder, Straw, and Hay)

Alfalfa (<i>Medicago sativa</i> subsp. <i>sativa</i>)
Bean, velvet (<i>Mucuna pruriens</i> var. <i>utilis</i>)
Clover (<i>Trifolium</i> spp., <i>Melilotus</i> spp.)
Kudzu (<i>Pueraria lobata</i>)
Lespedeza (<i>Lespedeza</i> spp.)
Lupin (<i>Lupinus</i> spp.)
Sainfoin (<i>Onobrychis viciifolia</i>)
Trefoil (<i>Lotus</i> spp.)
Vetch (<i>Vicia</i> spp.)
Vetch, crown (<i>Coronilla varia</i>)
Vetch, milk (<i>Astragalus</i> spp.)

Crop Group 19: Herbs and Spices

Table F-19 Crop Group 19: Herbs and Spices

Angelica (<i>Angelica archangelica</i>)
Anise (anise seed) (<i>Pimpinella anisum</i>)
Anise, star (<i>Illicium verum</i>)
Annatto (seed)
Balm (lemon balm) (<i>Melissa officinalis</i>)
Basil (<i>Ocimum basilicum</i>)
Borage (<i>Borago officinalis</i>)
Burnet (<i>Sanguisorba minor</i>)
Camomile (<i>Anthemis nobilis</i>)
Caper buds (<i>Capparis spinosa</i>)
Caraway (<i>Carum carvi</i>)
Caraway, black (<i>Nigella sativa</i>)
Cardamom (<i>Elettaria cardamomum</i>)
Cassia bark (<i>Cinnamomum aromaticum</i>)
Cassia buds (<i>Cinnamomum aromaticum</i>)
Catnip (<i>Nepeta cataria</i>)
Celery seed (<i>Apicum graveolens</i>)
Chervil (dried) (<i>Anthriscus cerefolium</i>)
Chive (<i>Allium schoenoprasum</i>)
Chive, Chinese (<i>Allium tuberosum</i>)
Cinnamon (<i>Cinnamomum verum</i>)
Clary (<i>Salvia sclarea</i>)
Clove buds (<i>Eugenia caryophyllata</i>)
Coriander (cilantro or Chinese parsley) (leaf) (<i>Coriandrum sativum</i>)
Costmary (<i>Chrysanthemum balsamita</i>)
Culantro (leaf) (<i>Eryngium foetidum</i>)
Culantro (seed) (<i>Eryngium foetidum</i>)
Cumin (<i>Cuminum cyminum</i>)
Curry (leaf) (<i>Murraya koenigii</i>)
Dill (dillweed) (<i>Anethum graveolens</i>)
Dill (seed) (<i>Anethum graveolens</i>)
Fennel (common) (<i>Foeniculum vulgare</i>)
Fennel, Florence (seed) (<i>Foeniculum vulgare Azoricum</i> Group)
Fenugreek (<i>Trigonella foenumgraecum</i>)
Grains of paradise (<i>Aframomum melegueta</i>)

Table F-19 Crop Group 19: Herbs and Spices (continued)

Horehound (<i>Marrubium vulgare</i>)
Hyssop (<i>Hyssopus officinalis</i>)
Juniper berry (<i>Juniperus communis</i>)
Lavender (<i>Lavandula officinalis</i>)
Lemongrass (<i>Cymbopogon citratus</i>)
Lovage (leaf) (<i>Levisticum officinale</i>)
Lovage (seed) (<i>Levisticum officinale</i>)
Mace (<i>Myristica fragrans</i>)
Marigold (<i>Calendula officinalis</i>)
Marjoram (<i>Origanum</i> spp.) (includes sweet or annual marjoram, wild marjoram or oregano, and pot marjoram)
Mustard (seed) (<i>Brassica juncea</i> , <i>B. hirta</i> , <i>B. nigra</i>)
Nasturtium (<i>Tropaeolum majus</i>)
Nutmeg (<i>Myristica fragrans</i>)
Parsley (dried) (<i>Petroselinum crispum</i>)
Pennyroyal (<i>Mentha pulegium</i>)
Pepper, black (<i>Piper nigrum</i>)
Pepper, white
Poppy (seed) (<i>Papaver somniferum</i>)
Rosemary (<i>Rosmarinus officinalis</i>)
Rue (<i>Ruta graveolens</i>)
Saffron (<i>Crocus sativus</i>)
Sage (<i>Salvia officinalis</i>)
Savory, summer and winter (<i>Satureja</i> spp.)
Sweet bay (bay leaf) (<i>Laurus nobilis</i>)
Tansy (<i>Tanacetum vulgare</i>)
Tarragon (<i>Artemisia dracunculus</i>)
Thyme (<i>Thymus</i> spp.)
Vanilla (<i>Vanilla planifolia</i>)
Wintergreen (<i>Gaultheria procumbens</i>)
Woodruff (<i>Galium odorata</i>)
Wormwood (<i>Artemisia absinthium</i>)

Crop Group 20: Oilseed

Table F-20 Crop Group 20: Oilseed

Borage (<i>Borago officinalis</i> L.)
Calendula (<i>Calendula officinalis</i> L.)
Castor oil plant (<i>Ricinus communis</i> L.)
Chinese tallowtree, (<i>Triadica sebifera</i> (L.) Small)
Cottonseed (<i>Gossypium hirsutum</i> L.; <i>Gossypium</i> spp.)
Crambe (<i>Crambe hispanica</i> L.; <i>C. abyssinica</i> Hochst. ex R.E. Fr.)
Cuphea (<i>Cuphea hyssopifolia</i> Kunth)
Echium (<i>Echium plantagineum</i> L.)
Euphorbia (<i>Euphorbia esula</i> L.)
Evening primrose (<i>Oenothera biennis</i> L.)
Flax seed (<i>Linum usitatissimum</i> L.)
Gold of pleasure (<i>Camelina sativa</i> (L.) Crantz)
Hare's ear mustard (<i>Conringia orientalis</i> (L.) Dumort)
Jajoba (<i>Simmondsia chinensis</i> (Link) C.K. Schneid.)
Lesquerella (<i>Lesquerella recurvata</i> (Engelm. ex A. Gray) S. Watson)
Lunaria (<i>Lunaria annua</i> L.)
Meadowfoam (<i>Limnanthes alba</i> Hartw. ex Benth.)
Milkweed (<i>Asclepias</i> spp.)
Mustard seed (<i>Brassica hirta</i> Moench, <i>Sinapis alba</i> L. subsp. <i>Alba</i> .)
Niger seed (<i>Guizotia abyssinica</i> (L.f.) Cass.)
Oil radish (<i>Raphanus sativus</i> L. var. <i>oleiformis</i> Pers.)
Poppy seed (<i>Papaver somniferum</i> L. subsp. <i>Somniferum</i>)
Rapeseed (<i>Brassica</i> spp.; <i>B. napus</i> L.)
Rose hip (<i>Rosa rubiginosa</i> L.)
Safflower (<i>Carthamus tinctorius</i> L.)
Sesame (<i>Sesamum indicum</i> L., <i>S. radiatum</i> Schumach. & honn.)
Stokes aster (<i>Stokesia laevis</i> (Hill) Greene)
Sunflower (<i>Helianthus annuus</i> L.)
Sweet rocket (<i>Hesperis matronalis</i> L.)
Tallowwood (<i>Ximenia americana</i> L.)
Tea oil plant (<i>Camellia oleifera</i> C. Abel)
Vernonia (<i>Vernonia galamensis</i> (Cass.) Less)
Cultivars, varieties, and/or hybrids of these

Crop Group 21: Edible Fungi

Table F-21 Crop Group 21: Edible Fungi

Blewitt (<i>Lepista nuda</i>)
Bunashimeji (<i>Hypsizygos marmoratus</i>)
Chinese mushroom (<i>Volvariella volvacea</i> (Bull.) Singer)
Enoki (<i>Flammulina velutipes</i> (Curt.) Singer)
Hime-Matsutake (<i>Agaricus blazei</i> Murill)
Hirmeola (<i>Auricularia auricular</i>)
Maitake (<i>Grifola frondosa</i>)
Morel (<i>Morchella</i> spp.)
Nameko (<i>Pholiota nameko</i>)
Net Bearing (<i>Dictyophora</i>)
Oyster mushroom (<i>Pleurotus</i> spp.)
Pom Pom (<i>Hericium erinaceus</i>)
Reishi mushroom (<i>Ganoderma lucidum</i> (Leyss. Fr.) Karst.)
Rodman's agaricus (<i>Agaricus bitorquis</i> (Quel.) Saccardo)
Shiitake mushroom (<i>Lentinula edodes</i> (Berk.) Pegl.)
Shimeji (<i>Tricholoma conglobatum</i>)
Stropharia (<i>Stropharia</i> spp.)
Truffle (<i>Tuber</i> spp.)
White button mushroom (<i>Agaricus bisporous</i> (Lange) Imbach)
White Jelly Fungi (<i>Tremella fuciformis</i>)

Crop Group 22: Stalk, Stem, and Leaf Petiole Vegetables

Table F-22 Crop Group 22: Stalk, Stem, and Leaf Petiole Vegetables

<p>Agave (<i>Agave</i> spp.)</p> <p>Aloe vera (<i>Aloe vera</i> (L.) Burm.f.)</p> <p>Asparagus (<i>Asparagus officinalis</i> L.)</p> <p>Bamboo shoots (<i>Arundinaria</i> spp., <i>Bambusa</i> spp., <i>Chimonobambusa</i> spp.; <i>Dendrocalamus</i> spp., <i>Fargesia</i> spp.; <i>Gigantochloa</i> spp., <i>Nastus elatus</i>; <i>Phyllostachys</i> spp.; <i>Thyrsostachys</i> spp.)</p> <p>Cardoon/Globe artichoke (<i>Cynara cardunculus</i> L.)</p> <p>Celery (<i>Apium graveolens</i> var. <i>dulce</i> (Mill.) Pers.)</p> <p>Celery, Chinese (<i>Apium graveolens</i> L. var. <i>secalinum</i> (Alef.) Mansf.)</p> <p>Celtuce (<i>Lactuca sativa</i> var. <i>angustana</i> L.H. Bailey)</p> <p>Fennel, Florence, fresh leaves and stalk (<i>Foeniculum vulgare</i> subsp. <i>vulgare</i> var. <i>azoricum</i> (Mill.) Thell.)</p> <p>Fern, edible, fiddlehead</p> <p>Fuki (<i>Petasites japonicus</i> (Siebold & Zucc.) Maxim.)</p> <p>Kale, sea (<i>Crambe maritima</i> L.)</p> <p>Kohlrabi (<i>Brassica oleracea</i> L. var. <i>gongylodes</i> L.)</p> <p>Palm hearts (various species)</p> <p>Prickly pear, pads (<i>Opuntia ficus-indica</i> (L.) Mill., <i>Opuntia</i> spp.)</p> <p>Prickly pear, Texas, pads (<i>Opuntia engelmannii</i> Salm-Dyck ex Engelm. var. <i>lindheimeri</i> (Engelm.) B.D. Parfitt & Pinkav)</p> <p>Rhubarb (<i>Rheum x rhabarbarum</i> L.)</p> <p>Udo (<i>Aralia cordata</i> Thunb.)</p> <p>Zuiki (<i>Colocasia gigantea</i> (Blume) Hook. f.)</p> <p>Cultivars, varieties, and hybrids of these commodities</p>

Crop Group 23: Tropical and Subtropical Fruit, Edible Peels

Table F-23 Crop Group 23: Tropical and Subtropical Fruit, Edible Peels

Açaí (<i>Euterpe oleracea</i> Mart.)
Acerola (<i>Malpighia emarginata</i> DC.)
Achachairú (<i>Garcinia gardneriana</i> (Planch. & Triana) Zappi)
African plum (<i>Vitex doniana</i> Sweet)
Agritos (<i>Berberis trifoliolata</i> Moric.)
Almondette (<i>Buchanania lanzan</i> Spreng.)
Ambarella (<i>Spondias dulcis</i> Sol. ex Parkinson)
Apak palm (<i>Brahea dulcis</i> (Kunth) Mart.)
Appleberry (<i>Billardiera scandens</i> Sm.)
Arazá (<i>Eugenia stipitata</i> McVaugh)
Arbutus berry (<i>Arbutus unedo</i> L.)
Babaco (<i>Vasconcellea x heilbornii</i> (V.M. Badillo) V.M. Badillo)
Bacaba palm (<i>Oenocarpus bacaba</i> Mart.)
Bacaba-de-leque (<i>Oenocarpus distichus</i> Mart.)
Bayberry, red (<i>Morella rubra</i> Lour.)
Bignay (<i>Antidesma bunius</i> (L.) Spreng.)
Bilimbi (<i>Averrhoa bilimbi</i> L.)
Borojó (<i>Borojoa patinoi</i> Cuatrec.)
Breadnut (<i>Brosimum alicastrum</i> Sw.)
Cabeluda (<i>Plinia glomerata</i> (O. Berg) Amshoff)
Cajou, fruit (<i>Anacardium giganteum</i> Hance ex Engl.)
Cambucá (<i>Marlierea edulis</i> Nied.)
Carandas-plum (<i>Carissa edulis</i> Vahl)
Carob (<i>Ceratonia siliqua</i> L.)
Cashew apple (<i>Anacardium occidentale</i> L.)
Ceylon iron wood (<i>Manilkara hexandra</i> (Roxb.) Dubard)
Ceylon olive (<i>Elaeocarpus serratus</i> L.)
Cherry-of-the-Rio-Grande (<i>Eugenia aggregata</i> (Vell.) Kiaersk.)
Chinese olive, black (<i>Canarium tramdenum</i> C.D. Dai & Yakovlev)
Chinese olive, white (<i>Canarium album</i> (Lour.) Raeusch.)
Chirauli-nut (<i>Buchanania latifolia</i> Roxb.)
Ciruela verde (<i>Bunchosia armeniaca</i> (Cav.) DC.)
Cocoplum (<i>Chrysobalanus icaco</i> L.)

Table F-24 Crop Group 23: Tropical and Subtropical Fruit, Edible Peels

Date (<i>Phoenix dactylifera</i> L.)
Davidson's plum (<i>Davidsonia pruriens</i> F. Muell.)
Desert-date (<i>Balanites aegyptiacus</i> (L.) Delile)
Doum palm coconut (<i>Hyphaene thebaica</i> (L.) Mart.)
False sandalwood (<i>Ximenia americana</i> L.)
Feijoa (<i>Acca sellowiana</i> (O. Berg) Burret)
Fig (<i>Ficus carica</i> L.)
Fragrant manjack (<i>Cordia dichotoma</i> G. Forst.)
Gooseberry, abyssinian (<i>Dovyalis abyssinica</i> (A. Rich.) Warb.)
Gooseberry, Ceylon (<i>Dovyalis hebecarpa</i> (Gardner) Warb.)
Gooseberry, Indian (<i>Phyllanthus emblica</i> L.)
Gooseberry, otaheite (<i>Phyllanthus acidus</i> (L.) Skeels)
Governor's plum (<i>Flacourtia indica</i> (Burm. F.) Merr.)
Grumichama (<i>Eugenia brasiliensis</i> Lam)
Guabiroba (<i>Campomanesia xanthocarpa</i> O. Berg)
Guava (<i>Psidium guajava</i> L.)
Guava berry (<i>Myrciaria floribunda</i> (H. West ex Willd.) O. Berg)
Guava, Brazilian (<i>Psidium guineense</i> Sw.)
Guava, cattley (<i>Psidium cattleyanum</i> Sabine)
Guava, Costa Rican (<i>Psidium friedrichsthalianum</i> (O. Berg) Nied.)
Guava, Para (<i>Psidium acutangulum</i> DC.)
Guava, purple strawberry (<i>Psidium cattleyanum</i> Sabine var. <i>cattleyanum</i>)
Guava, strawberry (<i>Psidium cattleyanum</i> Sabine var. <i>littorale</i> (Raddi) Fosberg)
Guava, yellow strawberry (<i>Psidium cattleyanum</i> Sabine var. <i>cattleyanum</i> forma <i>lucidum</i> O. Deg.)
Guayabillo (<i>Psidium sartorianum</i> (O. Berg) Nied.)
Illawarra plum (<i>Podocarpus elatus</i> R. Br. Ex Endl.)
Imbé (<i>Garcinia livingstonei</i> T. Anderson)
Imbu (<i>Spondias tuberosa</i> Arruda ex Kost.)
Indian-plum (<i>Flacourtia jangomas</i> (Lour.) basionym)
Jaboticaba (<i>Myrciaria cauliflora</i> (Mart.) O. Berg)
Jamaica-cherry (<i>Muntingia calabura</i> L.)
Jambolan (<i>Syzygium cumini</i> (L.) Skeels)
Jelly palm (<i>Butia capitata</i> (Mart.) Becc.)
Jujube, Indian (<i>Ziziphus mauritiana</i> Lam.)

Table F-25 Crop Group 23: Tropical and Subtropical Fruit, Edible Peels

Kaffir-plum (<i>Harphephyllum caffrum</i> Bernh. Ex C. Krauss)
Kakadu plum (<i>Terminalia latipes</i> Benth. subsp. <i>psilocarpa</i> Pedley)
Kapundung (<i>Baccaurea racemosa</i> (Reinw.) Mull. Arg.)
Karanda (<i>Carissa carandas</i> L.)
Kwai muk (<i>Artocarpus hypargyreus</i> Hance ex Benth.)
Lemon aspen (<i>Acronychia acidula</i> F. Muell)
Mangaba (<i>Hancornia speciosa</i> Gomes)
Marian plum (<i>Bouea macrophylla</i> Griff.)
Mombin, malayan (<i>Spondias pinnata</i> (J. Koenig ex L. f.) Kurz)
Mombin, purple (<i>Spondias purpurea</i> L.)
Mombin, yellow (<i>Spondias mombin</i> L.)
Monkeyfruit (<i>Artocarpus lacucha</i> Buch. Ham.)
Monos plum (<i>Pseudanmomis umbellulifera</i> (Kunth) Kausel)
Mountain cherry (<i>Bunchosia cornifolia</i> Kunth)
Nance (<i>Byrsonima crassifolia</i> (L.) Kunth)
Natal plum (<i>Carissa macrocarpa</i> (Eckl.) A. DC.)
Noni (<i>Morinda citrifolia</i> L.)
Olive (<i>Olea europaea</i> L. subsp. <i>europaea</i>)
Papaya, mountain (<i>Vasconcellea pubescens</i> A. DC.)
Patauá (<i>Oenocarpus bataua</i> Mart.)
Peach palm, fruit (<i>Bactris gasipaes</i> Kunth var. <i>gasipaes</i>)
Persimmon, black (<i>Diospyros texana</i> Scheele)
Persimmon, Japanese (<i>Diospyros kaki</i> Thunb.)
Pitomba (<i>Eugenia luschnathiana</i> Klotzsch ex O. Berg)
Plum-of-Martinique (<i>Flacourtia inermis</i> Roxb.)
Pomerac (<i>Syzygium malaccense</i> (L.) Merr. & L.M. Perry)
Rambai (<i>Baccaurea motleyana</i> (Mull. Arg.) Mull. Arg.)
Rose apple (<i>Syzygium jambos</i> (L.) Alston)
Rukam (<i>Flacourtia rukam</i> Zoll. & Moritizi)
Rumberry (<i>Myrciaria dubia</i> (Kunth) McVaugh Myrtaceae)
Sea grape (<i>Coccoloba uvifera</i> (L.) L.)
Sentul (<i>Sandoricum koetjape</i> (Burm. F.) Merr.)
Sete-capotes (<i>Campomanesia guazumifolia</i> (Cambess.) O. Berg)
Silver aspen (<i>Acronychia wilcoxian</i> (F. Muell.) T.G. Hartley)
Starfruit (<i>Averrhoa carambola</i> L.)
Surinam cherry (<i>Eugenia uniflora</i> L.)

Table F-26 Crop Group 23: Tropical and Subtropical Fruit, Edible Peels

Tamarind (<i>Tamarindus indica</i> L.)
Uvalha (<i>Eugenia pyriformis</i> Cambess)
Water apple (<i>Syzygium aqueum</i> (Burm. F.) Alston)
Water pear (<i>Syzygium guineense</i> (Willd.) DC)
Water berry (<i>Syzygium cordatum</i> Hochst. Ex C. Krauss)
Wax jambu (<i>Syzygium samarangense</i> (Blume) Merr. & L.M. Perry)
Cultivars, varieties, and hybrids of these commodities

Crop Group 24: Tropical and Subtropical Fruit, Inedible Peels

Table F-27 Crop Group 24: Tropical and Subtropical Fruit, Inedible Peels

Abiu (<i>Pouteria caimito</i> (Ruiz & Pav.) Radlk)
Aisen (<i>Boscia senegalensis</i> (Pers.) Lam.)
Akee apple (<i>Blighia sapida</i> K.D. Koenig)
Atemoya (<i>Annona cherimola</i> Mill. X <i>A. squamosa</i> L.)
Avocado (<i>Persea americana</i> Mill.)
Avocado, Guatemalan (<i>Persea americana</i> Mill. var. <i>guatemalensis</i>)
Avocado, Mexican (<i>Persea americana</i> Mill. var. <i>drymifolia</i> (Schltdl. & Cham.) S.F. Blak)
Avocado, West Indian (<i>Persea americana</i> var. <i>americana</i>)
Bacury (<i>Platonia insignis</i> Mart.)
Bael fruit (<i>Aegle marmelos</i> (L.) Corrêa)
Banana (<i>Musa</i> spp.)
Banana, dwarf (<i>Musa</i> hybrids; <i>Musa acuminata</i> Colla)
Binjai (<i>Mangifera caesia</i> Jack)
Biriba (<i>Annona mucosa</i> Jacq.)
Breadfruit (<i>Artocarpus altilis</i> (Parkinson) Fosberg)
Burmese grape (<i>Baccaurea ramiflora</i> Lour.)
Canistel (<i>Pouteria campechiana</i> (Kunth) Baehni)
Cat's-eyes (<i>Dimocarpus longan</i> Lour. subsp. <i>malesianus</i> Leenh.)
Champedak (<i>Artocarpus integer</i> (Thunb.) Merr.)
Cherimoya (<i>Annona cherimola</i> Mill.)
Cupuacú (<i>Theobroma grandiflorum</i> (Willd. Ex Spreng.) K. Schum.)
Custard apple (<i>Annona reticulata</i> L.)
Dragon fruit (<i>Hylocereus undatus</i> (Haw.) Britton & Rose)
Durian (<i>Durio zibethinus</i> L.)
Elephant-apple (<i>Limonia acidissima</i> L.)
Etambe (<i>Mangifera zeylanica</i> (Blume) Hook. F.)
Granadilla (<i>Passiflora ligularis</i> Juss.)
Granadilla, giant (<i>Passiflora quadrangularis</i> L.)
Ilama (<i>Annona macrophyllata</i> Donn. Sm.)
Ingá (<i>Inga vera</i> Willd. subsp. <i>affinis</i> (DC.) T.D. Penn.)
Jackfruit (<i>Artocarpus heterophyllus</i> Lam.)
Jatobá (<i>Hymenaea courbaril</i> L.)
Karuka (<i>Pandanus julianettii</i> Martelli)
Kei apple (<i>Dovyalis caffra</i> (Hook. F. & Harv.) Warb.)
Langsat (<i>Lansium domesticum</i> Corrêa)

Table F-28 Crop Group 24: Tropical and Subtropical Fruit, Inedible Peels

Lanjut (<i>Mangifera lagenifera</i> Griff.)
Longan (<i>Dimocarpus longan</i> Lour.)
Lucuma (<i>Pouteria lucuma</i> (Ruiz & Pav.) Kuntze)
Lychee (<i>Litchi chinensis</i> Sonn.)
Mabolo (<i>Diospyros blancoi</i> A. DC.)
Madras-thorn (<i>Pithecellobium dulce</i> (Roxb.) Benth.)
Mammy-apple (<i>Mammea americana</i> L.)
Manduro (<i>Balanites maughamii</i> Sprague)
Mango (<i>Mangifera indica</i> L.)
Mango, horse (<i>Mangifera foetida</i> Lour.)
Mango, Saipan (<i>Mangifera odorata</i> Griff.)
Mangosteen (<i>Garcinia mangostana</i> L.)
Marang (<i>Artocarpus odoratissimus</i> Blanco)
Marmaladebox (<i>Genipa americana</i> L.)
Matisia (<i>Matisia cordata</i> Humb. & Bonpl.)
Mesquite (<i>Prosopis juliflora</i> (Sw.) DC.)
Mongongo, fruit (<i>Schinziophyton rautanenii</i> (Schinz) Radcl.-Sm)
Monkey-bread-tree (<i>Adansonia digitata</i> L.)
Monstera (<i>Monstera deliciosa</i> Liebm.)
Nicobar-breadfruit (<i>Pandanus leram</i> Jones ex Fontana)
Paho (<i>Mangifera altissima</i> Blanco)
Pandanus (<i>Pandanus utilis</i> Bory)
Papaya (<i>Carica papaya</i> L.)
Passionflower, winged-stem (<i>Passiflora alata</i> Curtis)
Passionfruit (<i>Passiflora edulis</i> Sims)
Passionfruit, banana (<i>Passiflora tripartita</i> var. <i>mollissima</i> (Kunth) Holm-Niels. & P. Jorg.)
Passionfruit, purple (<i>Passiflora edulis</i> Sims forma <i>edulis</i>)
Passionfruit, yellow (<i>Passiflora edulis</i> Sims forma <i>flavicarpa</i> O. Deg.)
Pawpaw, common (<i>Asimina triloba</i> (L.) Dunal)
Pawpaw, small-flower (<i>Asimina parviflora</i> (Michx.) Dunal)
Pelipisan (<i>Mangifera casturi</i> Kosterm.)
Pequi (<i>Caryocar brasiliense</i> Cambess)
Pequia (<i>Caryocar villosum</i> (Aubl.) Pers.)
Persimmon, American (<i>Diospyros virginiana</i> L.)
Pineapple (<i>Ananas comosus</i> (L.) Merr.)
Pitahaya (<i>Hylocereus polyrhizus</i> (F.A.C. Weber) Britton & Rose)

Table F-29 Crop Group 24: Tropical and Subtropical Fruit, Inedible Peels

Pitaya (<i>Hylocereus</i> sp. including <i>H. megalanthus</i> (<i>H. ocamponis</i> and <i>H. polychizus</i>)
Pitaya, amarilla (<i>Hylocereus triangularis</i> Britton & Rose)
Pitaya, roja (<i>Hylocereus ocamponis</i> (Salm-Dyck) Britton & Rose)
Pitaya, yellow (<i>Hylocereus megalanthus</i> (K. Schum. ex Vaupel) Ralf Bauer)
Plantain (<i>Musa paradisiaca</i> L.)
Pomegranate (<i>Punica granatum</i> L.)
Poshte (<i>Annona liebmanniana</i> Baill.)
Prickly pear, fruit (<i>Opuntia ficus-indica</i> (L.) Mill.)
Prickly pear, Texas, fruit (<i>Opuntia engelmannii</i> Salm-Dyck ex Engelm. var. <i>lindheimeri</i> (Engelm.) B.D. Parfitt & Pinkav)
Pulasan (<i>Nephelium ramboutan-ake</i> (Labill.) Leenh.)
Quandong (<i>Santalum acuminatum</i> (R. Br.) DC.)
Rambutan (<i>Nephelium lappaceum</i> L.)
Saguaro (<i>Carnegiea gigantea</i> (Engelm.) Britton & Rose)
Sapodilla (<i>Manilkara zapota</i> (L.) P. Royen)
Sapote, black (<i>Diospyros digyna</i> Jacq.)
Sapote, green (<i>Pouteria viridis</i> (Pittier) Cronquist)
Sapote, mamey (<i>Pouteria sapota</i> (Jacq.) H.E. Moore & Stearn)
Sapote, white (<i>Casimiroa edulis</i> La Llave & Lex)
Sataw (<i>Parkia speciosa</i> Hassk.)
Satinleaf (<i>Chrysophyllum oliviforme</i> L.)
Screw-pine (<i>Pandanus tectorius</i> Parkinson)
Sierra Leone-tamarind (<i>Dialium guineense</i> Willd.)
Soncoya (<i>Annona purpurea</i> Moc. & Sessé ex Dunal)
Soursop (<i>Annona muricata</i> L.)
Spanish lime (<i>Melicoccus bijugatus</i> Jacq.)
Star apple (<i>Chrysophyllum cainito</i> L.)
Sugar apple (<i>Annona squamosa</i> L.)
Sun sapote (<i>Licania platypus</i> (Hemsl.) Fritsch)
Tamarind-of-the-Indies (<i>Vangueria madagascariensis</i> J.F. Gmel.)
Velvet tamarind (<i>Dialium indum</i> L.)
Wampi (<i>Clausena lansium</i> (Lour.) Skeels)
White star apple (<i>Chrysophyllum albidum</i> G. Don)
Wild loquat (<i>Uapaca kirkiana</i> Müll. Arg.)
Cultivars, varieties, and hybrids of these commodities

Appendix G

Respirator Protection Information

Contents

Introduction	G-1
Equipment Selection	G-1
MB 2016 Label	G-2
Responsibilities	G-4
Workplace Specific Respiratory Protection Program Elements	G-7
Respirator Selection, Use, and Limitations	G-9
Occupational Medical Monitoring Program (OMMP)	G-11
Fit Testing	G-13
Training	G-13
Care, Inspection, and Maintenance	G-14
Verbal Communication Considerations	G-16
Low Temperature Environment Considerations	G-17
High Temperature Environment Considerations	G-18

Introduction

The information in this chapter has been developed from the Department of Labor, Occupational Safety and Health Administration (OSHA) standard [Title 29, Code of Federal Regulations \(CFR\), Part 1910.134](#), and the APHIS Safety and Health Manual (under revision). These guidelines apply to all APHIS employees who must wear respiratory protection equipment. These are the minimum requirements for an effective respiratory protection program. USDA employees should also refer to the [USDA-APHIS-PPQ Safety and Health Sharepoint site](#) or Chapter 11 in the APHIS *Safety and Health Manual* on the APHIS myportal website for additional information.

Equipment Selection

USDA APHIS PPQ recommends two different types of supplied air systems to provide breathing air to employees conducting fumigation activities. These are:

- ◆ Self Contained Breathing Apparatus (SCBA)
- ◆ Cascade air supply system

Each of these systems is configured for one style of air mask. When methyl bromide concentrations are unknown or 5 ppm and above, employees must

wear and use SCBA. There is one approved air mask, the MSA Airhawk Ultra Elite. (Figure G-5)

MB 2016 Label

NOTICE

USDA APHIS PPQ approves the following half and full face air purifying respirators for use in areas where methyl bromide levels are between 1 and 5 ppm (refer to Appendix E for ordering information):

- ◆ **Half face respirators:** MSA Advantage 420, 3M 6100, 6200, 6300, North 7700, Survivair/Sperian 250000, 260000, 270000
- ◆ **Full face respirators:** MSA Advantage 1000, 3M 6700, 6800, 6900, North 76008AS/76008A

Refer to [Figure G-1](#) for approved half face respirators.



Figure G-1 Approved Half Face Respirators

Refer to [Figure G-2](#) for approved full face respirators.



Figure G-2 Approved Full Face Respirators

Refer to [Figure G-3](#) for approved organic vapor/acid gas/P100 cartridges for both full and half face respirators.



Figure G-3 Approved Organic Vapor/Acid Gas/P100 Cartridges

Refer to [Figure G-4](#) for approved SCBA.



Figure G-4 Approved SCBA

If needed, employees may also order spectacle kits for the MSA AirHawk. Models available include a center-support kit and a sidewire kit. See [Figure G-5](#).

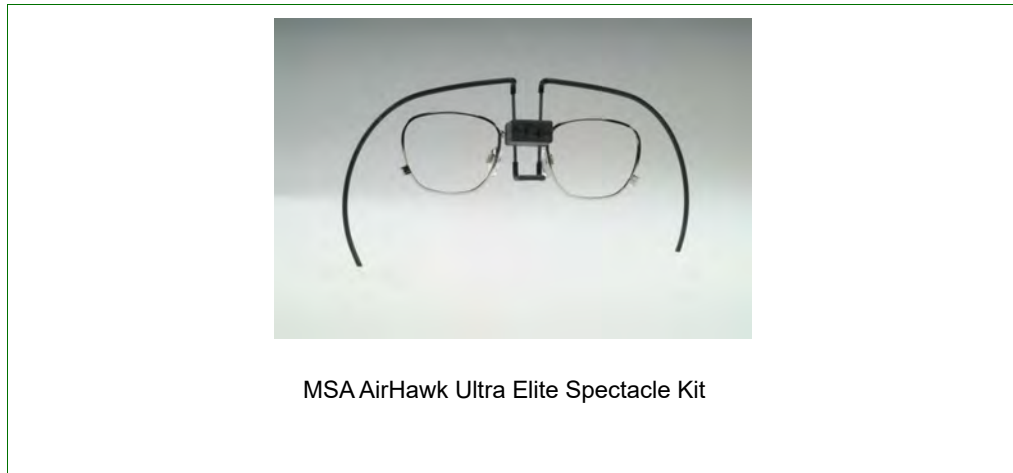

Figure G-5 Approved AirHawk Ultra Elite Spectacle Kit-Sidewire

Responsibilities

APHIS Safety, Health, and Environmental Programs

APHIS Safety, Health and Environmental Programs (SHEP) is responsible for:

- ◆ ensuring that a physician or other licensed health care professional determines that an employee is physically able to wear a respirator
- ◆ establishing a medical evaluation protocol for respirator users and is the authority on medical surveillance of respirators
- ◆ establishing and conducting a respiratory protection program according to the requirements of this manual and applicable OSHA standards when respiratory protection is required and used

Managers and Supervisors

In workplaces where respiratory protection is used managers and supervisors have a direct responsibility for protecting their employees and must:

- ◆ advise all respirator wearers that they may safely leave the area at any time for relief from respirator use in the event of equipment malfunction, physical or psychological distress, procedural or communication failure, significant deterioration of operating conditions, or any other conditions that might warrant such relief
- ◆ annually review the workplace-specific written plan and provide a copy to the appropriate safety and health office with proper signature for approval

- ◆ appoint an individual to be responsible for the use, maintenance, inspection, and care of common use, emergency, or escape respirators
- ◆ contact applicable safety and health office whenever workplace operations change to schedule appropriate evaluations when new hazardous materials are introduced, processes or procedures are changed, or engineering controls are modified or added
- ◆ develop, maintain, and enforce a workplace-specific written plan according to the guidance in 29 CFR 1910.134, Appendix A
- ◆ document training on the employee safety and health record, or electronic equivalent
- ◆ ensure employees in the respiratory protection program wear the approved respiratory protection for the hazard and for which they have been fit tested and trained
- ◆ ensure employees have received the necessary medical evaluations, training, and fit testing before engaging in workplace operations requiring the use of the respirator. Supervisors receive training from the applicable safety office and should contact applicable safety office if they become a manager/supervisor of a new work place
- ◆ follow and enforce the cartridge change-out schedule developed by supervisor/manager at worksite and include the schedule in the workplace-specific written plan
- ◆ maintain applicable standards in the workplace
- ◆ notify applicable safety and health office of conflicts between respiratory protection guidance and applicable standards
- ◆ notify applicable safety office when new employees require fit testing or when current employees have a change affecting their wear of respiratory protection
- ◆ provide copies of workplace-specific written plan to employees to hand-carry to their medical evaluation when requested
- ◆ provide for quality control of respirator breathing air (if used)

NOTICE

Cylinders of purchased breathing air have a certificate of analysis from the supplier. Discontinue the use of compressed breathing air and contact applicable safety office if sample results are unsatisfactory and/or employees complain of taste, odor or irritation from compressed breathing air.

- ◆ provide initial and periodic (annual and as changes occur) respiratory protection training, including training to all employees in their workplace who use “voluntary” use (filtering facepieces) respirators. (Refer to [29 CFR 1910.134, Appendix D](#) for mandatory training requirements for voluntary use respirators.)

Employee Responsibilities

Employees who wear respiratory protection will:

- ◆ complete initial respirator medical evaluation questionnaire (APHIS 29 Form, Occupational Exposures) and other physical examination requirements as needed prior to performing duties requiring respiratory protection
- ◆ ensure that no facial hair comes between the sealing surface of the facepiece and the face or interferes with valve function, if required, to wear a tight-fitting facepiece
- ◆ guard respirators against damage, do not use unsanitary, damaged or unserviceable respirators, and turn in unserviceable respirators to their supervisor
- ◆ inspect, clean, and maintain any respiratory protection device issued to them for their individual use
- ◆ maintain the integrity of the National Institute of Occupational, Safety and Health (NIOSH) certification by not mixing respirator parts from different manufacturers
- ◆ provide workplace-specific written program to the provider for the medical evaluation when requested
- ◆ receive initial and periodic training and fit testing (annual, and as changes occur)
- ◆ report to their supervisor any change in medical status which may impact their ability to safely wear respiratory protection (e.g., weight changes, facial scarring, dental changes, cosmetic surgery, disfigurement, etc.)
- ◆ use the provided respiratory protection according to the instructions and training received
- ◆ wear only that respiratory protection for which they have received fit testing and training, and only for the tasks specified

Work Unit Responsibilities

With assistance from the applicable safety office, the work unit will:

- ◆ conduct fit testing on those individuals who have been medically cleared by a physician or licensed health care provider
- ◆ conduct routine surveys in workplaces where respirators are used
- ◆ educate and train workplace supervisors, and those individuals appointed to oversee the use, maintenance, and care of common use, or escape-only respirators. Supervisor training will be repeated when a supervisor becomes a supervisor of a different workplace
- ◆ ensure fit testing is conducted according to OSHA and APHIS guidelines

- ◆ maintain or have immediate access to current copies (paper or electronic) of applicable OSHA standards (i.e., 29 CFR 1910, 29 CFR 1926), and the NIOSH Certified Equipment List
- ◆ provide guidance to workplace supervisors, as necessary, in the preparation of the workplace-specific written plan and annual training program
- ◆ review workplace-specific written plans annually to ensure respiratory protection procedures are addressed and submit to applicable safety office for approval (refer to [Figure A-22](#) on page [A-1-42](#) for a site plan template or see the [USDA-APHIS-PPQ Safety and Health Sharepoint site](#) for site-specific plans)

Physician or Other Licensed Health Care Professional (PLHCP)

The physician or PLHCP will:

- ◆ conduct medical evaluations of individuals identified to wear a respirator, as required
- ◆ medically clear individuals to wear a respirator
- ◆ review the respirator medical evaluation questionnaires and document as outlined in [Occupational Medical Monitoring Program \(OMMP\)](#)

Workplace Specific Respiratory Protection Program Elements

The respiratory protection program must be conducted in accordance with OSHA's standard 29 CFR 1910.134, *APHIS Safety and Health Manual*, and this *Treatment Manual*.

The program elements of a respiratory protection program will be shared among workplace supervisors, employees and the applicable safety office. Only NOISH/MSHA approved respirators can be used by employees in federal workplaces. No privately-procured respiratory protection device will be used by federal employees in workplaces

Management must develop procedures to address the following at each workplace:

- ◆ fit testing procedures for tight-fitting respirators in 29 CFR 1910.134(f)
- ◆ program evaluation procedures in 29 CFR 1910.134(l)

NOTICE

Management must ensure the respiratory protection program is evaluated annually. The applicable safety office should assist management during review and report the findings in writing to workplace supervisor with recommendation for correction if necessary.

- ◆ training procedures in 29 CFR 1910.134(k)

The program evaluation will review the adequacy of the following elements as a minimum:

- ◆ air supply and breathing air (review of air testing results as appropriate) and checking for breathing air outlet incompatibilities with other gas lines
- ◆ filters used for each hazard
- ◆ maintenance and storage practices (shared, emergency use, and individual respirators)
- ◆ the respirator for workplace exposures
- ◆ work practices, documentation of inspections of shared and emergency use respirators, and documentation of respirator training

The findings of these evaluations may be included in the workplace survey reports.

Medical evaluations will be conducted as outlined in [Occupational Medical Monitoring Program \(OMMP\)](#).

Workplace-Specific Program Elements

Supervisors in workplaces where respiratory protection is used must develop a written plan as required by 29 CFR 1910.134(c). The plan must be approved by the applicable safety office. Workplace-specific written plans must include the following:

- ◆ duration and frequency of respirator use (including use for rescue and escape if applicable)
- ◆ expected physical work effort involved in the process requiring respiratory protection (see 29 CFR 1910.134 Appendix C, Part B)
- ◆ proper use of respirators in routine and emergency situations
- ◆ protective clothing and equipment to be worn while wearing the respirator
- ◆ selection criteria—describe the processes in which respirators are required
- ◆ type and weight of the respirators used by employees
- ◆ temperature and humidity extremes that may be encountered
- ◆ training procedures for required respirators (see 29 CFR 1910.134(k)(1-6))
- ◆ use, maintenance, and care procedures (describe the criteria that employees use to determine when respirator filters, cassettes, or cartridges must be changed)

Supervisors must ensure that approved respirators in their workplace are used, are used correctly, and are in good condition.

Respirator Selection, Use, and Limitations

Select respirators according to 29 CFR 1910.134 (d) and the NIOSH Certified Equipment List. Document the rationale for selection in the workplace-specific written plan.

If a more stringent standard such as a substance-specific OSHA standard exists for the contaminants, follow those guidelines and requirements for respirator selection.

Employee Activity

Consider each employee's activity and location in an inhalational hazardous area when selecting the proper respiratory protection. For example, whether the employee is in the hazardous area continuously or intermittently during the work shift and whether the work rate is light, medium, or heavy.

Respirator Use Conditions

Take into account the period of time a respirator must be worn when selecting a respirator. Consider the type of respirator application, such as for routine, non-routine, emergency, or rescue use.

Location of the Potential Hazardous Area

Consider the location of the hazardous area with respect to a safe area, which has respirable air, when selecting a respirator. This will permit planning for the escape of employees if an emergency occurs, entry of employees to perform maintenance duties, and rescue operations.

Operational Limitations

Environmental conditions and level of effort required of the respirator wearer may affect respirator service life. For example, extreme physical exertion can cause the user to deplete the air supply in a SCBA such that its service life is reduced by half or more.

Immediately Dangerous to Life or Health (IDLH) Conditions

Evaluate all possible actions, such as increasing ventilation or isolating the source of contaminants, to attain an atmosphere that is not IDLH before authorizing employees to enter areas known to have IDLH conditions. Refer to 29 CFR 1910.134 g (3) and g(4) for procedures for IDLH atmospheres.

Other Exposure Routes

Consider other exposure routes (e.g., skin absorption or external radiation) when selecting respiratory protection. Wearing the respirator could increase exposure by longer stay times in a hazardous environment such as exposures to external radiation.

Document respirator selection on the workplace-specific written respiratory protection plans.

Respirator Limitations

In addition to the following, refer to the requirements in 29 CFR 1910.134:

- ◆ Communications—consider ambient environmental noise and communication needs when specific respirators are selected. See [Verbal Communication Considerations](#).
- ◆ Eye Irritation—if contaminants cause eye irritation, wear full facepiece respirators or chemical protective goggles with half facepiece respirators.
- ◆ Respirators in Low Temperature Environments—low temperatures may cause detrimental effects on the performance of respirators. Consider the effects of low temperatures in the selection and maintenance of respirators and respirable gas supplies. See [Low Temperature Environment Considerations](#).
- ◆ Respirators In High Temperature Environments—high temperatures may affect the performance of the respirator, and may add undue physiological stress. Consider the effects of high temperatures in respirator selection and for medical approvals. See [High Temperature Environment Considerations](#).

Corrective Lenses

PPQ will pay for corrective lenses; however, employees are required to pay for the personal doctor visit to get the prescription for the lenses.

WARNING

Wearing of contact lenses in contaminated atmospheres with a respiratory protection device is **prohibited**.

Occupational Medical Monitoring Program (OMMP)

Medical Evaluation

Potential respirator wearers must complete a respirator medical evaluation questionnaire and/or may receive a physical examination prior to initial fit testing to identify existing medical conditions that would place the employee at an increased health risk from the use of a respirator or interfere with the use or wear of a respirator. The OSHA standard 29 CFR 1910.134 (e) and Appendix C specifies the minimum mandatory requirements for medical evaluations. Supervisors will assist employees in the completion of the APHIS Form 29 Occupational Exposure and ensure that the employees required to use respirators are medically qualified and fit-tested for the appropriate respirator. Contact the applicable PPQFO safety manager with any questions regarding the medical clearance process before using a respirator.

Respirator Questionnaires and Medical Evaluations

All health care providers conducting medical evaluations and reviewing completed respirator medical evaluation questionnaires for the respiratory protection program must be a physician or other licensed health care professional (PLHCP), as defined in 29 CFR 1910.134 (b). The Federal Occupational Health (FOH) Medical Advisor meets the requirements of the PLHCP and will be referred to as such in this section.

The medical evaluation consists of the respirator medical evaluation questionnaire and a physical examination if wearing SCBA. The FOH Medical Advisor determines medical evaluation expirations.

Following review of the respirator medical evaluation questionnaire, follow-up medical evaluation may be needed. The FOH Medical Advisor will determine what is needed. The FOH Medical Advisor is the determining official for the employee's ability to use a respirator.

The FOH Medical Advisor's written recommendation will be in the form of a medical clearance letter (MCL). The MCL is sent to the employee and employer (applicable PPQFO Safety Manager). It is the employee's responsibility to provide a copy of the MCL to his/her supervisor. MCL's will be one of the following:

- ◆ MCL for respirator use **without restrictions**
- ◆ MCL for respirator use **with restrictions**. Follow all restrictions on the MCL.
 - ❖ If an employee recovers from the medical condition and the restrictions can be lifted, the employee's personal doctor must notify

the FOH Medical Advisor so the recommendations and restrictions can be updated.

- ◆ MCL for no respirator use.
 - ❖ The employee will not be allowed to perform any work activities that require the use of a respirator. The FOH Medical Advisor will convey to the employee the reason for the failure to pass the examination and give the employee appropriate options. The reasons are personal health issues identified through the medical history and physical examination (including any testing) during the clearance process. In some cases, there may be no options available. In most cases, there are remedies that can be achieved by the employee working with his/her healthcare provider. The employee has the option to do nothing, in which case, the MCL for no respirator use will still stand.
 - ❖ The employee may elect to go to their personal physician to treat the condition. All expenses for personal health issues are the responsibility of the employee. Any documentation to support reconsideration for medical clearance by the FOH Medical Advisor, must be submitted to the FOH medical advisor by the employee or their healthcare provider. Final determination for medical clearance rests with the FOH medical advisor.

Follow-up Medical Evaluations

Based on an employee's answers on the respirator medical evaluation questionnaire, a follow-up medical evaluation may be required. The follow up medical evaluation can be in the form of a physical examination, blood work, and/or a stress test.

Workplace supervisors should be communicating with their employees and know if they may have developed medical conditions affecting respirator use since initial fit testing. Discretion is advised.

Supervisors should brief employees if there are any questions or concerns about an employee's ability to use a respirator due to a medical condition.

The supervisor will notify as soon as possible, the applicable safety and health office if a worker who uses a respirator develops a medical condition that could affect their ability to use a respirator.

When a worker reports to an annual respirator fit test, a program appointed fit-tester will formally (e.g., with written verification that is locally developed) ask if the employee has experienced any difficulty wearing a respirator and if personnel are medically cleared to wear a respirator. If the worker responds with a change in medical history, he or she will be directed back to the supervisor, and will not be fit-tested until cleared by the FOH Medical Advisor.

Fit Testing

Fit Testing Procedures

Before an employee may be required to wear a respirator with a tight-fitting facepiece, the employee must be fit tested with the same make, model, style, and size of respirator that will be used in the workplace. Current fit tests from other installations may be used if the employee will be using the same make, model and style of respirator.

Perform fit testing according to 29 CFR 1910.134 and the APHIS Safety and Health Manual.

Fit Test Failures

If a medically cleared employee cannot attain an adequate fit with a tight-fitting respirator the applicable safety and health office should be contacted for assistance.

Record Keeping

Records of respirator fit test results will include the information required in 29 CFR 1910.134 (m)(2)(i)(A-E). This information will be recorded on an Certificate of Respirator Fit Test, or equivalent.

Copies of respirator fit test results will be given to the employee and their supervisor to be maintained and filled in personnel records.

User Seal Check Procedures

Employees who use tight-fitting respirators will perform a user seal check to ensure that an adequate seal is achieved each time the respirator is donned. Employees will use either the positive and negative pressure check methods listed in 29 CFR 1910.134, Appendix B-1, or the respirator manufacturer's recommended user seal check method.

Training

Initial Training

All personnel will receive initial respiratory protection training prior to wearing a respirator. Use the USDA SF Form 182, Authorization, Agreement and Certification of Training, to document the initial and annual training.

Management will provide or arrange for the initial training of supervisors who have the responsibility of overseeing work activities of one or more persons who must wear respirators and respirator wearers. Training will include the requirements of 29 CFR 1910.134 (k).

Periodic Training

Trained workplace supervisors will provide annual instruction and retraining to respirator wearers. Training may also be conducted by applicable safety office or fit-tester during the annual fit testing. Management will provide retraining when notified by the supervisor of changes in the workplace or the type of respirator which render previous training obsolete. Management will also provide retraining when notified of or observed inadequacies in the employee's knowledge or use of the respirator indicate that the employee has not retained the requisite understanding or skills.

Supervisors must discuss respiratory protection requirements with employees during routine surveillance inspection. Supervisor training will be repeated when a supervisor is relocated to a different workplace.

Documentation

Document training in AgLearn or electronic equivalent.

Care, Inspection, and Maintenance

Employees who are issued a respirator are responsible for its primary maintenance and care. Where respirators are used collectively or kept ready for emergencies by a workplace or operating activity, the supervisor of the activity is responsible for establishing a respirator maintenance and cleaning program as specified in 29 CFR 1910.134. This program includes care, inspection, and maintenance of respirators.

Respirators

- ◆ Cleaning and Disinfecting
 - ❖ In addition to the requirements in 29 CFR 1910.134, respirators issued to an individual must be cleaned and disinfected, at a minimum, using a respirator wipe at the end of each day in which the respirator is used. Each respirator must be thoroughly cleaned and disinfected before being worn by a different individual. Emergency use respirators must be thoroughly cleaned and disinfected after being used. Refer to 29 CFR 1910.134, Appendix B-2.
- ◆ Storage
 - ❖ Refer to 29 CFR 1910.134
- ◆ Respirable Air and Oxygen for SCBA and Air-line Respirators
 - ❖ Compressed gaseous air, compressed gaseous oxygen, liquid air, and liquid oxygen used for respiration must be of high purity and tested.
- ◆ Inspection

- ❖ Inspect respirators per 29 CFR 1910.134.
- ❖ Each air and oxygen cylinder must be inspected to ensure that it is fully charged according to the manufacturer's instructions.
- ❖ The employee must inspect the respirator immediately before each use and during cleaning to ensure that it is in proper working condition. Inspect emergency or escape-only respirators prior to carrying it into the workplace. After cleaning and disinfecting, inspect each respirator to determine if it is in proper working condition, needs replacement of parts or repairs, or needs to be discarded. Each respirator stored for emergency or rescue use must be inspected at least monthly. Refer to 29 CFR 1910.134 (h)(3).
- ❖ The record of inspection of emergency or rescue respirators must be maintained on Inspection/Maintenance Record. Respirators that do not meet applicable inspection criteria must be immediately removed from service and repaired or replaced.
- ◆ Maintenance
 - ❖ Refer to 29 CFR 1910.134(h) for maintenance and repair instructions.
 - ❖ Change cartridges, filters, or canisters of air-purifying respirators immediately after each use or if air is restricted when breathing.
 - ❖ If, at any time an employee detects an increase in breathing resistance, smells or tastes the contaminant, or detects the irritant properties of the contaminant the employee must immediately leave the area and replace the cartridge, filter or canister.

Breathing Air Quality and Use and Testing of Breathing Air Containers

Breathing air quality and use, testing, and breathing air containers must comply with 29 CFR 1910.134(i).

Ambient or Free-Air Pumps and Compressors

The workplace supervisor is responsible for inspecting ambient or free-air pumps and compressors used with air-line (supplied-air) systems.

- ◆ Air-line couplings must be incompatible with outlets for other gas systems to prevent inadvertent servicing of air-line respirators with other gases or oxygen.
- ◆ Inspect the air-line, compressor and respirator to ensure all three components match the air pressure and other requirements specified by the manufacturers.
- ◆ Place the pumps in a position to avoid entry of contaminated air into the system.

Verbal Communication Considerations

Verbal communication in a noisy industrial environment can be difficult. It is important to ensure that respirator wearers can comfortably communicate when necessary because an employee who is speaking very loudly or yelling may cause a facepiece seal leak, and the employee may be tempted to temporarily dislodge the device in order to communicate. Both situations are undesirable. There are several options that may be used to aid communications when wearing respirators.

Speaking Diaphragms

A speaking diaphragm consists of a resonating surface and cavity that vibrates during speech, amplifying the speaker's voice outside of the respirator.

Consider the following when using speaking diaphragms:

- ◆ Not all facepiece respirators are available with a speaking diaphragm. Contact the equipment manufacturer for availability.
- ◆ There are key components in maintaining the airtight integrity of the facepiece requiring care when installing and handling.
- ◆ Use of a respirator with a speaking diaphragm during welding, cutting, burning, or grinding operations is of special concern, as flying sparks may burn a hole in the diaphragm, creating a leak. Some manufacturers have compensated for these applications by providing shrouds to cover the diaphragm or by using metal diaphragms.

Built-In Microphones

Some respirator manufacturers make small microphones that are mounted inside or connected to the respiratory inlet covering. The microphone may be connected to a radio, telephone, loudspeaker, or other means of electronic transmittal. Consider the following when using built-in microphones:

- ◆ Any component that is attached to or through the respiratory inlet covering may affect its function. In cases where the manufacturer provides components, strictly adhere to the installation instructions and leak test procedures to ensure that airtight integrity is maintained.
- ◆ Voice activated communication systems may cause continuous sound pickup of the blower, when used with powered air-purifying respirators, or air flow noise, when used with supplied air devices.

Hand or Coded Signals

A predetermined set of signals may be useful in communicating.

Cranial, Throat, or Ear Microphones

Cranial and throat microphones are held in place with a harness against the wearer's head and larynx, respectively. Ear microphones are worn in the same manner as a transistor radio earphone and function as both a microphone and speaker. Use of these devices does not require making penetrations or attachments to the respirator, and does not impact the NIOSH certification status. They may be used with radios, telephones, loudspeakers, or other means of electronic transmittal, similar to facepiece microphones. Consider the following when using cranial, throat, or ear microphones:

- ◆ Do not place cranial microphones under the head harness of facepiece respirators since their dislodgement may loosen the respirator straps.
- ◆ When connecting wires are passed underneath the bibs or neck seals of supplied-air hoods or helmets, attach them to the wearer's body to avoid disturbing the bib positioning.

Telephone Handsets

Since a person exhales while speaking, the exhalation valve in a facepiece respirator is partially open. This is a perfect location to place a handset or hand-held microphone to obtain the clearest voice transmission. An alternative is to hold the handset or microphone to the wearer's throat while speaking.

Safety Considerations

Electronic devices shall be selected and used with caution in explosive atmospheres or Class I hazardous locations identified in Article 501 of the National Electric Code (NEC). When required, ensure all such devices comply with requirements for permissibility and intrinsically safe systems according to Article 504 of the NEC. Consider the effects of radio frequency emissions when utilizing such devices in the vicinity of sensitive electronic equipment.

Low Temperature Environment Considerations

A low temperature environment may cause lens fogging in a respiratory inlet covering and freezing or improper sealing of the valves. Coating the inside surface of the lens may inhibit fogging at temperatures approaching 0 degrees Celsius (°C) (32 degrees Fahrenheit (°F)). Full facepieces are available with nose cups that direct the warm and moist exhaled air through the exhalation valve without contacting the lens. Facepieces with nose cups may provide satisfactory vision at temperatures as low as -32 °C (-25 °F).

SCBA equipped with a full facepiece and certified for use below 32 °F shall be equipped with a nose cup or other suitable accessory or coating to maintain the device's NIOSH certification when it is used in environments below 32 °F.

Additionally, there are several other important considerations that users should be aware of when using SCBA in a low temperature environment. Users should thoroughly review the manufacturer's instructions and, if necessary, consult with the manufacturer to become thoroughly familiar with the precautions and recommendations for use of a specific SCBA in cold weather conditions. In general, consider the following:

- ◆ Storage—elastomeric components such as facepieces and breathing tubes may be prone to distortion if improperly stored in cold weather; such distortion could prevent the user from an adequate fit
- ◆ Accessory availability—cold temperature accessories and components such as special elastomeric gaskets and diaphragms may not be readily available

Respirator valves may freeze open or closed due to the presence of moisture at very low temperatures. Some air-line respirators are approved with a device called a “vortex tube” that warms the air supplied to the respiratory inlet covering of the respirator.

High Temperature Environment Considerations

Working in a high temperature environment while wearing a respirator creates additional stress on the wearer. Using a respirator that has a low weight, offers a low resistance to breathing, possesses a minimal dead air space, and, if feasible, provides a tempering of inlet air should minimize the additional stress.

Dead air volume is the volume of previously exhaled air (which is available to be inhaled) remaining in a respiratory inlet covering. Reducing the amount of dead air volume in a respirator reduces the level of carbon dioxide in the inhaled air, which is a major source of respirator usage related stress. This can be accomplished through the use of powered air-purifying respirators, continuous flow air-line respirators, use of a half facepiece respirator in lieu of a full facepiece, and use of a nose cup in full face-piece devices (regardless of the mode of operation).

Air-line respirators are recommended for use in a high temperature environment. Air-line respirators approved with a vortex tube will substantially reduce the temperature of the air supplied to the respirator. If air-purifying respirators are to be used, a half facepiece respirator, where it offers adequate protection, is preferable to the full facepiece.

Elastomeric components of respirators stored in high temperature environments may deteriorate at an accelerated rate and the facepiece may become permanently distorted. Use special care to prevent facepiece distortion.

Index

A
B
C
D
E
F
G
H
I
J
K
L
M
N
O
P
Q
R
S
T
U
V
W
X
Y
Z

A

- a.i. [Glossary-1](#)
- ability to heat
 - methyl bromide [2-8](#)
- abiu
 - irradiated from Hawaii [5-77](#)
- absorbed dose [3-5](#)
- Acalypha*
 - treatment options [5-25](#)
- acceptable daily intake [Glossary-1](#)
- Achatina*
 - cold treatment [5-101](#), [5-14](#)
 - MB at NAP treatment [5-6](#)
 - other treatment options [5-9](#)
- Achatinidae
 - cold treatment [5-101](#), [5-14](#)
- Achimenes* [5-19](#)
- Aconitum*
 - treatment options [5-25](#)
- acorn
 - nonpropagative [5-9](#)
 - propagative [5-31](#)
- actionable pests [5-20](#)
- adding gas and time
 - oak logs T312a [2-37](#)
 - oak logs T312a-Alternate [2-37](#)
 - other than T101 or equivalent [2-37](#)
- additional readings
 - methyl bromide [2-31](#)
- ADI [Glossary-1](#)
- aerating
 - fresh fruit, vegetables, and cut flowers [2-43](#)
 - nonsorptive containerized cargo [2-40](#)
 - nonsorptive, noncontainerized cargo [2-41](#)
 - sorptive containerized cargo [2-46](#)
 - sorptive noncontainerized cargo [2-44](#)
- aeration
 - flexible duct [E-4](#)
 - requirements
 - methyl bromide [2-12](#)
 - phosphine [2-30](#)
 - sulfuryl fluoride [2-5](#)
- aerosol insecticides [E-4](#)
- Africanized honeybee swarms
 - residual insect spray treatment [5-5](#)
- Fromomum melgueta* [5-37](#), [5-38](#)
- Agrilus planipennis*
 - heat treatment [5-46](#)
- Agriolimacidae
 - MB at NAP treatment [5-5](#), [5-10](#)
- Agriolimax*
 - MB at NAP treatment [5-5](#), [5-10](#)
- air cargo covers Dupont™ Tyvec® [8-28](#)
- air curtain velocity measurement [8-17](#)
- air pump, auxiliary [E-5](#)
- air velocity measuring instrument [8-17](#)
- Airbus Industries of North America, Inc. [5-38](#)
- aircraft
 - treatment options [5-38](#)
- air-purifying respirator [E-6](#)
- Alabama
 - state hazardous waste management agencies [7-11](#)
- Alaska
 - state hazardous waste management agencies [7-11](#)
- Aleurocanthus woglumi*
 - MB at NAP treatment [5-35](#), [5-12](#)
- Aleurocanthus woglumi* host plants
 - treatment options [5-12](#)
- alfalfa seeds [5-16](#)
- Allium* [5-18
 - schoenoprasum* \[5-37\]\(#\), \[5-38\]\(#\)
 - tuberosum* \[5-37\]\(#\), \[5-38\]\(#\)](#)
- allspice [5-37](#), [5-38](#)
- Aloe* [5-19](#)
- alpha grass and handicrafts
 - treatment options [5-19](#)
- Amaryllis* [5-18](#), [5-23](#)
- ambrosia timber beetles [5-20](#)
- American
 - Conference of Governmental Industrial Hygienists (ACGIH) [Glossary-1](#)
- American Samoa
 - state hazardous waste management agencies [7-11](#)
- Amorphophallus* [5-19](#)
- Ampelodesma mauritanicus* [5-19](#)
- Ampelopsis* [5-19](#)
- Amphulariidae
 - hot water treatment [5-2](#)
- Anastrepha fraterculus*
 - MB at NAP treatment [5-8](#), [5-9](#)
 - vapor heat treatment [5-84](#)
- Anastrepha ludens*
 - cold treatment [5-88](#)
 - forced hot air treatment [5-68](#)
 - hot water treatment [5-65](#)
- Anastrepha obliqua*
 - forced hot air treatment [5-68](#)
- Anastrepha serpentina*
 - forced hot air treatment [5-68](#)
- Anastrepha* spp.
 - cold treatment [5-89](#)

- forced hot air treatment 5-67
 MB at NAP/chamber only treatment 5-24
 vapor heat treatment 5-81
- Anchusa* 5-19
 anemometer 8-17
Anemone 5-19
 angelica 5-37, 5-38
Angelica archangelica 5-37, 5-38
 Animal and Plant Health Inspection Service Glossary-1
 anise 5-37, 5-38
 anise star 5-37, 5-38
 annato seed 5-37, 5-38
 ant
 residual insecticidal spray treatment 5-5
Anthemis nobilis 5-37, 5-38
Anthemum graveolens 5-37, 5-38
Anthonomus grandis
 MB at NAP/tarpaulin only treatment 5-5
Anthriscus cerefolium 5-37, 5-38
 ants
 MB at NAP treatment 5-71, 5-53
 treatment 5-20
Aphelenchoides besseyi
 hot water treatment 5-21, 5-22
Aphelenchoides fragariae 5-20
 hot water treatment (Lilium) 5-24
 hot water treatment (*Senecio*) 5-24
Aphelenchoides subtenuis
 hot water treatment 5-23
 aphids
 MB at NAP treatment 5-71, 5-4
 APHIS Glossary-1
 APHIS Form
 205-R, Instructions and Worksheet for Calibrating Portable Temperature Sensors A-3
 2061, Residue Sample for Food or Feed Product A-2
 206-R, Test of the Accuracy of the Permanent RTD Sensors Installed in Hot Water Tanks A-4
 207-R, Sensor Location Diagram Fruit Weights and Pulp Temperatures A-5
 208, Performance Test for Mango Hot Water Immersion Tant A-6
Apium graveolens 5-37, 5-38
 apple maggot
 irradiation treatment 5-76
 apples 5-3
 T107-a 5-87
 T107-a-1 5-87
 T107-b 5-88
 T107-d 5-89
 T108-a 5-94
 T109-a-1 5-98
 T109-d-1 5-97
 apricot 5-3, 5-87, 5-88, 5-89
 aquatic plants infested with freshwater snails
 hot water treatment 5-2
Araucaria spp.
 MB at NAP treatment 5-9
- Archachatina* 5-9
 cold treatment 5-14
 MB at NAP treatment 5-6
- Arion*
 MB at NAP treatment 5-5, 5-10
- Arionidae
 MB at NAP treatment 5-5, 5-10
- Arizona
 state hazardous waste management agencies 7-11
- Arkansas
 state hazardous waste management agencies 7-12
- Armoracea 5-19
Artemisia absinthium 5-37, 5-38
Artemisia dracunculoides 5-37, 5-38
 Ascarite® 8-5, E-9
Ascochyta spp. 5-12
 ash logs 5-46
 Asian citrus psyllid 5-13
 asparagus 5-4
 from Thailand, Australia, and New Zealand 5-4
- asphalt surfaces 5-4
Asphodelus fistulosus 5-54
Astilbe 5-19, 5-22
 root 5-22
- atmospheric fumigation chambers
 basic design elements 6-2
 certification of 6-1
 circulation and exhaust systems 6-6
 construction and performance standards 6-1
 other auxiliary equipment 6-10
- Austrotortrix* spp.
 cold treatment followed by MB at NAP 5-97
 MB at NAP followed by cold treatment 5-96
 autoclaves E-39
Autographa gamma
 MB at NAP treatment 5-44
- automobiles 5-29
 restricted MB fumigation item 2-11
- auxiliary pump 8-18
 avocado 5-87, 5-94
 FIFRA section 18 exemption 2-3
 from Hawaii, Israel, Philippines 5-5
 seeds only, without pulp 5-30
 avocado seed moth
 MB in 26" vacuum treatment 5-30
 avocado seed weevil
 MB in 26" vacuum treatment 5-30
 avocado stem weevil
 MB in 26" vacuum treatment 5-30
- Azalea* 5-9
Azalea indica 5-9
 azaleodendron 5-4
- B**
Bactrocera cucurbitae
 cold treatment 5-91
 forced hot air treatment 5-68, 5-69
 fumigation plus cold treatment 5-94
 irradiation treatment 5-76
 MB at NAP treatment 5-5

A

B

C

D

E

F

G

H

I

J

K

L

M

N

O

P

Q

R

S

T

U

V

W

X

Y

Z

- vapor heat treatment 5-81, 5-83
- Bactrocera dorsalis*
- cold treatment 5-68, 5-69, 5-91
 - fumigation plus cold treatment 5-94
 - hot water immersion treatment 5-64
 - irradiation treatment 5-76
 - MB at NAP treatment 5-5
 - vapor heat treatment 5-81, 5-82, 5-83, 5-84
- Bactrocera jarvisi*
- irradiation treatment 5-76
- Bactrocera occipitalis*
- vapor heat treatment 5-83
- Bactrocera philippinensis*
- vapor heat treatment 5-83
- Bactrocera tryoni*
- cold treatment 5-89
 - cold treatment followed by MB at NAP 5-97
 - fumigation plus cold treatment 5-94
 - MB at NAP followed by cold treatment 5-96
- bags and bagging material 5-23
- for cotton only 5-22
 - for small grains 5-6
 - for soil-grown commodities 5-5
 - for unroasted coffee beans 5-24
 - to contain root crops 5-22
 - treatment schedules for 5-22, 5-29
- baking powder
- restricted MB fumigation item 2-11
- balances (portable) for weighing individual E-10
- baled hay
- treatment options 5-33
- baled lint
- treatment options 5-2
- balm, lemon 5-37, 5-38
- banana 5-5
- FIFRA section 18 exemption 2-3
 - FIFRA section 18 exemption 2-3
 - irradiated from Hawaii 5-77, 5-22
- barges 5-29
- Baris lepidii*
- MB in 15" vacuum treatment 5-39
- bark/engraver beetle
- treatment 5-20
- bark-gnawing beetle
- treatment 5-20
- basil 5-37, 5-38
- batch system E-10
- bay leaf 5-37, 5-38
- bean
- dry 5-6
 - fava, dried 5-30
 - lablab 5-35
 - snap 5-35
 - string 5-35
- bee treatment 5-20
- beet 5-6, 5-7
- Begonia* 5-19, 5-21
- bell pepper 5-81
- Berberis* 5-9
- bess beetle
- treatment 5-20
- black caraway 5-37, 5-38
- black fruit fly
- forced hot air treatment 5-68
- black pepper 5-37, 5-38
- blackberry 5-7
- blended strip tobacco 5-26
- Bletilla hyacinthina* 5-19, 5-20, 5-22
- blower E-13
- blueberry 5-8, 5-9, 5-10, 5-87
- blueprints
- restricted MB fumigation item 2-11
- Boeing Commercial Aeroplane Group 5-38
- boilers and thermostatic controls
- adequate water heating capacity 3-7
- boll weevil
- MB at NAP/tarpaulin only treatment 5-5
 - phosphine at NAP treatment 5-5
- bone meal
- restricted MB fumigation item 2-11
- borago 5-37, 5-38
- Borago officinalis* 5-37, 5-38
- borers
- chlorpyrifos spray treatment 5-17
 - dry heat treatment 5-10
 - MB at NAP treatment 5-23
 - MB at NAP/chamber only treatment 5-9
 - MB in 15" vacuum treatment 5-3, 5-15, 5-21
 - MB in 26" vacuum treatment 5-7
 - SF at NAP treatment 5-18
- Bostrichidae
- treatment 5-20
- box and package
- aeration 2-8
 - penetration 2-8
- Brachycerus*
- MB in 15" vacuum treatment 5-22, 5-23
 - MB in 15" vacuum/chamber only treatment 5-31
- Brachyrhinus*
- MB in 26" vacuum treatment 5-22
- Bradybaena*
- cold treatment 5-100, 5-12
- Bradybaena*
- cold treatment 5-12, 5-13
 - MB at NAP treatment 5-12
- branch borer
- treatment 5-20
- Brassica* 5-37, 5-37, 5-38, 5-38
- campestris* 5-11, 5-14
- Brassica* leafy vegetables 2-4
- Brassica* leafy vegetables F-6
- Brassica napus* 5-54
- Brassica nigra* 5-37, 5-38
- Brassica oleracea* 5-13
- Brassica oleracea* L. var. *alboglabra* 5-11
- Brassica oleracea* var. *acephala* 5-26
- Brassica oleracea* var. *botrytis* 5-10, 5-17
- Brassica oleracea* var. *gemmifera* 5-12
- Brassica oleracea* var. *gongylode* 5-42
- Brassica pekinensis* 5-14
- Brassica rapa Japonica* group 5-46
- Brassica rapa Perviridis* group 5-47
- brassware
- from Mumbai, India 5-55
- breadfruit 5-61

A
B
C
D
E
F
G
H
I
J
K
L
M
N
O
P
Q
R
S
T
U
V
W
X
Y
Z

- irradiated from Hawaii 5-77, 5-78
- break bulk cargo
 - fan arrangement and operation 2-16
 - gas introduction lines 2-17
 - gas sampling tubes 2-18, 2-20
- Brevipalpus chilensis*
 - irradiation treatment 5-76
 - MB at NAP treatment 5-24
 - soapy water and wax treatment 5-61, 5-62, 5-66
- broccoli 5-10
 - Chinese 5-11
 - raap 5-11
- bromeliads 5-2, 5-11, 5-9
- broomcorn and broomcorn articles 5-30
 - treatment 5-30, 5-24
- brooms made of rice straw 5-14
- Bruchidae
 - MB at NAP treatment 5-6, 5-30, 5-49, 5-53, 5-45
 - MB in 26" vacuum treatment 5-39, 5-46
 - MB in 26" vacuum/chamber only treatment 5-30
- Bruchophagus
 - MB in 26" vacuum treatment 5-43
- brussels sprouts 5-12
- bubble fumigation system E-14
- bulb nematode
 - hot water dip treatment 5-24
 - other treatment options 5-18, 5-20
- bulb scale mite
 - hot water treatment 5-27
 - MB at NAP treatment 5-26
- bulb vegetables not on the label
 - FIFRA section 18 exemption 2-4
- bulbs 5-18
- bulbs, corms, tubers, rhizomes, and roots 5-22
- Bulinidae
 - hot water treatment 5-2
- Buprestidae
 - treatment 5-20
- burnet 5-37, 5-38
- butter
 - restricted MB fumigation item 2-11
- bw Glossary-1
- C**
- CA
 - controlled atmosphere Glossary-1
- cabbage 5-12, 5-13
 - Chinese 5-13, 5-14
 - Chinese mustard 5-14
- cabbageworm
 - MB at NAP treatment 5-16
- cactus 5-3, 5-19
 - FIFRA section 18 exemption 2-3
- Calendula officinalis* 5-37, 5-38
- calibration companies approved E-58
- calibration of temperature probes
 - cold A-7
- California
 - state hazardous waste management agencies 7-12
- Calla*
 - rhizomes 5-21
- Calliopsis* 5-19
- Camellia* 5-9, 5-10
- Campanula* 5-19
- Candidula* 5-100, 5-6, 5-9, 5-13
- cantaloupe 5-15
- Cape gooseberry 5-87
- caper buds 5-37, 5-38
- Capparis spinosa* 5-37, 5-38
- Capsicum* spp.
 - irradiated from Hawaii 5-77
- Caracollina*
 - MB at NAP treatment 5-7, 5-11
- carambola 5-89, 5-91
 - irradiated from Hawaii 5-77
- caraway 5-37, 5-38
- caraway, black 5-37, 5-38
- carbon dioxide 2-4
- cardamom 5-37, 5-38
- Caribbean fruit fly
 - irradiation treatment 5-76
- carpenter ant
 - SF at NAP treatment 5-18
 - treatment 5-20
- carpenter bee
 - SF at NAP treatment 5-18
 - treatment 5-20
- carpenter worm
 - treatment 5-21
- Carposina niponensis*
 - cold treatment followed by MB at NAP 5-98
- carrot 5-15
- Carum carvi* 5-37, 5-38
- Caryedon* spp. 5-43
- CAS Glossary-1
- Cascade Air Tank Recharging System E-14
- cassava
 - manihot 5-16
 - yucca 5-16
- cassia bark, buds 5-37, 5-38
- Cathaica 5-12, 5-13
- Cathaica* 5-100, 5-12
- catnip 5-37, 5-38
- cattleya fly
 - MB in 15" vacuum treatment 5-15
- cauliflower 5-17
- Caulophilus latinasus*
 - MB in 26" vacuum treatment 5-30
- cavalo broccolo 5-17
- cc Glossary-1
- cecidiomyid galls 5-15
- celeriac 5-18
- celery
 - above ground 5-18
 - root 5-18
 - seed 5-37, 5-38
- central nervous system Glossary-1
- Cepaea*
 - cold treatment 5-100, 5-13
 - MB at NAP treatment 5-7, 5-11
- Cerambycidae
 - chlorpyrifos spray treatment 5-17

A

B

C

D

E

F

G

H

I

J

K

L

M

N

O

P

Q

R

S

T

U

V

W

X

Y

Z

- treatment 5-20
- Ceratitis capitata* 5-69
- Ceratitis capitata*
- cold treatment 5-87, 5-88, 5-90
 - cold treatment followed by MB at NAP 5-97
 - forced hot air treatment 5-68, 5-69
 - fumigation plus cold treatment 5-94
 - hot water immersion treatment 5-63, 5-64
 - irradiation treatment 5-76
 - MB at NAP followed by cold treatment 5-96
 - MB at NAP treatment 5-5, 5-8, 5-9, 5-23, 5-33, 5-40, 5-57, 5-58
 - vapor heat treatment 5-81, 5-82, 5-84
- Ceratitis rosa*
- cold treatment 5-87, 5-90
- CERCLA Glossary-1
- Cercospora mamaonis*
- hot water dip treatment 5-22
- Cercospora* spp.
- Bordeaux dip or spray treatment 5-22
- Ceruela*
- cold treatment 5-100, 5-13
 - MB at NAP treatment 5-6, 5-9
- Cersospora* spp. treatment options 5-4
- certified precision 8-25
- certifying
- facilities 6-1
 - forced hot air treatment facilities 6-1
 - heat treatment of firewood facilities 6-1
 - hot water immersion treatment facilities 6-1
 - irradiation treatment facilities 6-1
 - vacuum fumigation chambers 6-1
 - vapor heat treatment facilities 6-1
- certifying atmospheric fumigation chambers 6-1
- certifying facilities 6-1
- Cestrum* 5-19
- CFM calculation (fans) 8-17
- chain hoist, electronic E-14
- chamomile 5-37, 5-38
- charcoal
- restricted MB fumigation item 2-11
- chayote fruit only 5-19
- ChE Glossary-1
- chemical treatments
- fumigants 2-1
 - methyl bromide 2-1
 - overview 2-1
- CHEMTREC Glossary-1
- cherimoya from Chile 5-61
- cherry 5-19, 5-87, 5-88, 5-94
- chervil 5-37, 5-38
- chestnut 5-21, 5-31
- chestnut diion 5-7
- chicory
- above ground 5-22
 - root 5-22
- Chilean false red mite
- soapy water and wax treatment 5-61
- Chilean false red mite of grapes
- MB at NAP treatment 5-24
 - soapy water and wax treatment 5-66
- chives 5-37, 5-38
- cholinesterase Glossary-1
- Christmas trees 5-4
- treatment schedules for 5-44
- Chrysanthemum* 5-4, 5-21
- balsamita* 5-37, 5-38
 - rooted and unrooted cuttings 5-4
 - spp. 5-11
- Chrysanthemum* spp.
- rooted and unrooted cuttings 5-5
- chrysolid beetle
- MB in 15" vacuum/chamber only treatment 5-23
- Chrysomya* spp. 5-4, 5-5, 5-7
- cigarette beetle
- Kabat application treatment 5-26
 - MB in 28" vacuum treatment 5-27
 - vacuum steam flow treatment 5-26
- Cimicifuga* 5-19, 5-22
- cinder blocks
- restricted MB fumigation item 2-11
- Cinnamomum aromaticum* 5-37, 5-38
- Cinnamomum verum* 5-37, 5-38
- cinnamon 5-37, 5-38
- Cipollini bulbs 5-23
- Cissus* 5-19
- citrus
- from citrus canker countries 5-11
 - from Hawaii 5-68
 - from Mexico and infested U.S. areas 5-67
 - from the U.S. 5-23
 - seeds of 5-44
- citrus blackfly
- MB at NAP treatment 5-35, 5-12
- citrus canker
- domestic treatment 5-10
 - hot water treatment plus chemical dip 5-44
- Citrus hystrix* 5-38
- citrus whitefly
- MB at NAP treatment 5-10, 5-13
- citrus whitefly hosts
- MB at NAP treatment 5-9
- clary 5-37, 5-38
- Clean Water Act Glossary-2
- clear-winged moths 5-21
- Clematis* 5-19
- clementine 5-87
- from Chile 5-24
 - from Mexico 5-81, 5-82
- clementine from Mexico and U.S. quarantine areas 5-24
- clove buds 5-37, 5-38
- CO2 scrubbers
- restricted MB fumigation item 2-11
- coast guard regulations B-1
- Cochlicella*
- cold treatment 5-100, 5-13
 - MB at NAP treatment 5-6, 5-9
- coconut
- whole, without husk 5-26
- codling moth
- irradiation treatment 5-76
 - MB at NAP/chamber only treatment 5-20
- cold storage 5-25
- cold treatment

A
B
C
D
E
F
G
H
I
J
K
L
M
N
O
P
Q
R
S
T
U
V
W
X
Y
Z

- certifying self refrigerated containers 6-11
integral containers used for cold treatment
temperature recording instrument 6-14
vessels used for intransit cold treatment 6-2
approval requirements 6-3
temperature recording systems standards 6-2
warehouse certification 6-14
- coles 5-25
collard greens 5-26
Colorado
state hazardous waste management agencies 7-12
- Colosius* 5-5
MB at NAP treatment 5-10
- commercial suppliers E-1
Comprehensive Environmental Response, Compensation, and Liability Act (CERCLA) Glossary-1
conifer seeds 5-32, 5-33
Connecticut
state hazardous waste management agencies 7-12
- Conogethes punctiferalis*
cold treatment followed by MB at NAP 5-98
- Conopomorpha sinensis*
cold treatment 5-91
- Conotrachelus nenuphar* 5-76
Conotrachelus spp.
MB in 26" vacuum treatment 5-30
- construction equipment 5-29
without cabs 5-30
- consultants, hot water immersion treatments E-15
- containerized cargo
methyl bromide 2-13
tarpaulin fumigation 2-13
fan arrangement and operation 2-17
gas introduction lines 2-17
gas sampling tubes 2-19
- containers 5-29, 5-7
used 5-30
- continuous flow system 3-5
contracting officer's representative Glossary-1
- Convallaria* 5-18
conversion tables C-1
Convolvulus japonicus 5-19
Copitarsia spp.
MB at NAP treatment 5-4, 5-5, 5-7, 5-45, 5-52, 5-55
- copra 5-26, Glossary-1
Copturus aguacatae
MB in 26" vacuum treatment 5-30
- COR Glossary-1
coriander 5-37, 5-38
Coriandrum sativum 5-37, 5-38
- corn
corn-on-the-cob 5-27
related diseases, treatment schedules for 5-10
seed, nonpropagative 5-10
seed, not for food, feed, or oil purposes 5-11
shelled and contaminated with cottonseed 5-15
- Corytholoma* 5-19
- Cossidae treatment 5-21
costmary 5-37, 5-38
cotton and cotton products 5-5
samples of 5-8
treatment schedules for 5-2
- cottonseed 5-3, 5-6, 5-7
bagged, packaged, or bulk 5-34
hulls 5-6, 5-7
meal 5-4, 5-6, 5-7
- covers
for small grains 5-6
for soil-grown commodities 5-5
for wheat 5-7
- CPK Glossary-1
creatine phosphokinase Glossary-1
- cricket
residual insecticidal spray treatment 5-5
- Crociosema aporema*
MB in 15" vacuum/chamber only treatment 5-35
- Crocus* 5-23
Crocus sativus 5-37, 5-38
- crop group
berries and small fruit F-14
bulb vegetables F-4
cereal grains F-17
citrus fruit F-11
cucurbit vegetables F-10
edible fungi F-25
forage, fodder, and straw of cereal grains F-18
fruiting vegetables F-9
grass forage, fodder, hay F-19
herbs and spices F-21
leafy vegetables except *Brassica* F-5
leaves of legume vegetables F-8
leaves of root and tuber vegetables F-3
legume vegetables F-7
nongrass animal feed F-20
oilseed F-24
pome fruit F-12
root and tuber F-2
stone fruit F-13
tree nuts F-16
tropical and subtropical fruit, edible peels F-27, F-28, F-29, F-30
- Cryptomphalus*
MB at NAP 5-7
- Cryptophlebia*
illepida 5-76
illepida, MB at NAP treatment 5-37, 5-38
ombrodelta 5-76
- cu.m Glossary-1
cubic meter Glossary-1
cucumber 5-27
cucurbit vegetables
FIFRA section 18 exemption 2-4
- Cucurbita* spp.
irradiated from Hawaii 5-77
- cumin 5-37, 5-38
Cuminum cyminum 5-37, 5-38
Curculio caryae 5-91
Curculio spp.
MB at NAP 5-9

A

B

C

D

E

F

G

H

I

J

K

L

M

N

O

P

Q

R

S

T

U

V

W

X

Y

Z

- MB at NAP treatment 5-21, 5-31, 5-9
 MB in 26" vacuum/chamber only treatment 5-21
- Curculionidae
 treatment 5-20
- Curcuma* 5-19
 curry leaf 5-37, 5-38
- Cuscuta* spp.
 dry heat treatment 5-54
 steam heat treatment 5-54
- cut
 conifer Christmas trees 5-44
 flowers and greenery 5-21
 flowers and greenery treatment schedules 5-20
 pine Christmas trees 5-44
 pine logs 5-44
- CWA Glossary-2
 cycads 5-6, 5-9, 5-11
Cyclamen 5-19
 cyclamen mite
 MB in 15" vacuum treatment 5-11
- Cydia fabivora*
 MB at NAP treatment 5-35
 MB in 15" vacuum/chamber only treatment 5-35
- Cydia pomonella*
 irradiation treatment 5-76
 MB at NAP/chamber only treatment 5-20
- Cydia splendana*
 MB at NAP treatment 5-21, 5-31, 5-9
 MB in 26" vacuum/chamber only treatment 5-21, 5-9
- Cylas formicarius elegantulus*
 irradiation treatment 5-76
- Cymbopogon citratus* 5-37, 5-38
 cyst nematode
 hot water treatment 5-20
- Cytec® Industries, Inc. 2-31
- Cytisus* 5-19
- D**
Dahlia 5-19
Daphne spp. 5-9
 dasheen 5-28, 5-29
 FIFRA section 18 exemption 2-3
 deciduous woody plants, dormant 5-6
 decision tables, how to use 1-6
 Degesch Fumi-Cel® 5-48, 5-61
 Degesch Fumi-Strip® 5-48, 5-61
 Degesch Phostoxin® 5-48, 5-61
 Degesch Phostoxin® Tablet Prepac Rope 5-48, 5-61
 Delaware
 state hazardous waste management agencies 7-12
 deoxyribonucleic acid Glossary-2
Deroceras 5-5, 5-10
 Detia 5-48, 5-61
 Detia Gas EX-B 5-48, 5-61
 Detia Rotox AP 5-48, 5-61
 DHEW Glossary-2
Dialeurodes citri
 foliated host plants treatment options 5-10
 MB at NAP treatment 5-10, 5-13
 nonfoliated host plants treatment options 5-13
- Dicentra* 5-19
Dieffenbachia spp. 5-8, 5-11
 digital thermistor instrument E-17
Digitaria spp.
 dry heat treatment 5-54
- dill 5-37, 5-38
Dioon edule 5-7
Dioscorea spp. 5-60, 5-29
- dip treatment
 equipment 2-1
 procedures
 clean up 2-4
 designate restricted use areas 2-3
 dip plants 2-4
 disinfect original shipping containers 2-4
 dry plants 2-4
 prepare pesticide solution 2-3
 prepare plant material 2-3
 release cargo 2-4
 remove plants 2-4
 responsibilities 2-5
- Diplosolenodes* 5-5
 disinfectants E-26
 District of Columbia
 state hazardous waste management agencies 7-12
- DNA Glossary-2
 dosage calculations
 preparation 2-25, 2-15
 dose mapping 3-5
 dosimeter 3-5
 dosimetry 3-5
 DOT
 U.S. Department of Transportation Glossary-2
- Drierite® 8-4, E-19
 drinking water Glossary-2
 dry heat 5-24
 drying tube
 thermal conductivity gas analyzers 8-4
- DW Glossary-2
- E**
 ECO2FUME® 2-8
 electrical power supply
 tarpaulin fumigation sites 2-11
 electronic equipment
 restricted MB fumigation item 2-11
Elettaria cardamomum 5-37, 5-38
 emerald ash borer
 heat treatment 5-46
 empty holds 5-5
 Environmental Protection Agency Glossary-2
 EPA Glossary-2
 EPDM rubber
 restricted MB fumigation item 2-11
 equipment reference guide to commercial suppliers E-1
 exhaust duct E-19
 exhaust outlet 8-4
 exhausting gas

A

B

C

D

E

F

G

H

I

J

K

L

M

N

O

P

Q

R

S

T

U

V

W

X

Y

Z

- conducting fumigation 2-21
- external feeder Glossary-2
- F**
- FAA Glossary-2
- feather pillows
 - restricted MB fumigation item 2-11
- Federal Aviation Administration Glossary-2
- Federal Insecticide, Fungicide, and Rodenticide Act Glossary-2
- feeds and milled products 5-25
- FIFRA Glossary-2
- FIFRA Section 18 Exemption 5-2
- FIFRA section 18 exemption
 - avocado 2-3
 - banana 2-3
 - cactus 2-3
 - crop group
 - Brassica leafy vegetables 2-4
 - cucurbit vegetables 2-4
 - leafy vegetables 2-4
 - leaves of roots and tubers 2-4
 - root and tuber 2-3
 - stone fruit 2-4
 - unlabeled commodities from bulb vegetables 2-4
 - dasheen 2-3
 - herbs and spices, fresh 2-3
 - ivy gourd 2-3
 - kaffir lime leaves 2-3
 - longan 2-3
 - lychee 2-3
 - Malvaceae seeds 2-3
 - mint, dried 2-3
 - mint, fresh 2-3
 - plantain 2-3
 - pointed gourd 2-3
 - pomegranate 2-3
 - rambutan 2-3
 - treatment schedules 1-9
- final reading methyl bromide 2-31
- Florida
 - state hazardous waste management agencies 7-13
- forced hot air treatment facilities
 - certification of 6-1
 - documentation 6-7
 - plan and process approval 6-2
 - preliminary performance testing 6-3
- forced hot air treatment official performance testing 6-4
- Formicidae 5-20
- forms
 - APHIS Form 205-R, Instructions and Worksheet for Calibrating Portable Temperature Sensors A-3
 - APHIS Form 206-R, Test of the Accuracy of the Permanent RTD Sensors Installed in Hot Water Tanks A-4
 - APHIS Form 207-R, Sensor Location Diagram Fruit Weights and Pulp Temperatures A-5
 - Calibration of Temperature Probes (Cold Treatment) A-7
 - Location of Temperature Sensors in Containerized Cargo (Cold Treatment) A-8
 - PPQ Form 203, Foreign Site Certificate of Inspection and/or Treatment A-32
 - PPQ Form 429A, Fumigation Record A-9, A-12
 - PPQ Form 449-R, Temperature Recording Calibration Report A-30
 - PPQ Form 519, Compliance Agreement A-17
 - PPQ Form 523, Emergency Action Notification A-20
 - PPQ Form 556, In Transit Cold Treatment Clearance Report A-35
- fresh herbs
 - FIFRA section 18 exemption 2-3
- fresh mint
 - FIFRA section 18 exemption 2-3
- fresh spices
 - FIFRA section 18 exemption 2-3
- frozen food locker 5-25
- fruit sizing equipment 3-6, E-20
- fumigant selector switch
 - thermal conductivity gas analyzers 8-4
- fumigants
 - physical properties of 2-5
 - thermal conductivity gas analyzer 8-2
- fumigation
 - definition of 2-1
 - guidelines 2-3
- fumigators, commercial E-21
- Fumiphos
 - bags 5-48
 - pellets 5-48
 - tablets 5-48
- Fumiscope® 8-2
- Fumitoxin® 5-48
- fungal diseases
 - steam sterilization treatment 5-18
- fungal rice diseases
 - dry heat treatment 5-16
- fungicides E-21
- G**
- g Glossary-2
- Galium odorata* 5-37, 5-38
- gas analyzers E-23
- gas detector tubes 8-13
- gas detector tubes or gas samples 8-13
- gas drying tube for Drierite® E-26
- gas introduction
 - methyl bromide 2-27, 2-17
- gas introduction lines
 - methyl bromide 2-17
- gas penetration and distribution 2-15
- gas sampling tubes
 - methyl bromide 2-18, 2-12
- Gastoxin® 5-48
- gastrointestinal Glossary-2
- Gaultheria procumbens* 5-37, 5-38
- Georgia
 - state hazardous waste management agencies 7-13

A
B
C
D
E
F
G
H
I
J
K
L
M
N
O
P
Q
R
S
T
U
V
W
X
Y
Z

- GI Glossary-2
 grains of paradise 5-37, 5-38
 grams Glossary-2
 gray 3-5, Glossary-2
 Guam
 state hazardous waste management agencies 7-13
 Gy 3-5, Glossary-2
H
 Hawaii
 state hazardous waste management agencies 7-13
 hazard communication program 7-1
 HDT
 highest dose tested Glossary-2
 heat treatment of firewood facilities
 conducting test treatment 6-2, 6-5
 contact information 6-6
 documentation 6-6
 heat treatment of firewood facilities
 calibrating temperature sensors 6-3
 certification 6-1
 certification frequency 6-5
 official certification testing 6-3
 plan approval 6-2
 thermal mapping 6-4
 heat treatments, list of 3-1
 hemoglobin Glossary-2
 herbs and spices, fresh
 FIFRA section 18 exemption 2-3
 Hgb Glossary-2
 HHS Glossary-2
 high-protein flours
 restricted MB fumigation item 2-12
 hitchhiker Glossary-2
 hot water immersion
 circulation 3-8
 hydrocooling 3-15
 post-treatment cooling options 3-14
 pretreatment warming options 3-14
 safeguarding treated fruit 3-13
 temperature recorder specifications 3-9
 temperature sensor specifications 3-8
 hot water immersion treatment
 batch system 3-5
 continuous flow system 3-5
 facilities
 annual performance test 6-4
 certification 6-1
 foreign treatment facility protocols 6-7
 permanent probe temperature 6-4
 preliminary performance testing 6-2
 facility electrical components 3-6
 USDA checklist 3-4
 facility design 3-4
 on-site inspection 3-4
 proposal submission 3-4
 hot water immersion treatment consultants E-15
I
 i.m. Glossary-2
 i.p. Glossary-2
 i.v. Glossary-2
 Idaho
 state hazardous waste management agencies 7-13
 Illinois
 state hazardous waste management agencies 7-13
 impervious surface
 methyl bromide 2-10
 Indiana
 state hazardous waste management agencies 7-13
 infrared spectroscopy gas monitoring device Spectros 8-9
 inhalation reference dose Glossary-4
 internal feeder Glossary-2
 intramuscular Glossary-2
 intransit cold treatment
 certified vessels and containers 6-2
 temperature recording equipment standards 6-2
 vessel certification 6-3
 intraperitoneal Glossary-2
 intravenous Glossary-2
 ionizing radiation 3-5
 Iowa
 state hazardous waste management agencies 7-13
 irradiation 3-1, 3-5
 approved sources 6-4
 ASTM Standards 6-13
 audits 6-13
 compliance agreements 6-10
 conditions for recertification 6-11
 documentation 3-4
 domestic pre-certification 6-2
 dose mapping 3-4
 dosimetry 3-3
 dosimetry system 6-5
 facility certification 6-1
 foreign pre-certification 6-2
 standard operating procedures 6-7
 terminology 3-5
 treatment objectives 3-2
 irradiation treatment facilities
 certification of 6-1
 ivy gourd
 FIFRA section 18 exemption 2-3
 FIFRA Section 18 Exemptions 2-3
J
Juniperus communis 5-37, 5-38
K
 kaffir lime leaves
 FIFRA section 18 exemption 2-3
 FIFRA Section 18 Exemptions 2-3
 Kansas
 state hazardous waste management agencies 7-14
 Kentucky
 state hazardous waste management agencies 7-14
 kg Glossary-2
 kilogram Glossary-2

A

B

C

D

E

F

G

H

I

J

K

L

M

N

O

P

Q

R

S

T

U

V

W

X

Y

Z

L

L Glossary-3

lard

restricted MB fumigation item 2-11

Laurus nobilis 5-37, 5-38*Lavendula officinalis* 5-37, 5-38

LC50 Glossary-3

LCLO Glossary-3

LD50 Glossary-3

LDLO Glossary-3

LDT Glossary-3

leafy vegetables

FIFRA section 18 exemption 2-4

leather goods

restricted MB fumigation item 2-12

leaves of roots and tubers

FIFRA section 18 exemption 2-4

LEL Glossary-3

lemon balm 5-37, 5-38

lethal concentration 50 Glossary-3

lethal concentration low Glossary-3

lethal dose 50 Glossary-3

lethal dose low Glossary-3

Levisticum officinale 5-37, 5-38

line switch

thermal conductivity gas analyzers 8-4

line switches

thermal conductivity gas analyzers 8-4

liter Glossary-3

LOAEL Glossary-3

Lobesia botrana

MB at NAP treatment 5-8

MB chamber treatment 5-9

MB tarp or chamber treatment 5-9, 5-10

location of temperature sensors in containerized cargo (cold treatment) A-8

logs and firewood treatment schedules 5-46

longan

FIFRA section 18 exemption 2-3

Louisiana

state hazardous waste management agencies 7-14

lower exposure limit Glossary-3

lowest dose tested Glossary-3

lowest-observed-adverse-effect-level Glossary-3

lychee

FIFRA section 18 exemption 2-3

M

m Glossary-3

mace 5-37, 5-38

magazines

restricted MB fumigation item 2-12

magnesium articles

restricted MB fumigation item 2-12

magnesium phosphide E-27

Maine

state hazardous waste management agencies 7-14

Malvaceae seeds

FIFRA section 18 exemption 2-3

manometer 8-19, E-27

margin of safety Glossary-3

Maryland

state hazardous waste management agencies 7-14

Massachusetts

state hazardous waste management agencies 7-14

MB Glossary-3

McDonald Douglas Corporation 5-38

MED Glossary-3

Melissa officinalis 5-37, 5-38*Mentha pulegium* 5-37, 5-38

metam-sodium E-30

meter Glossary-3

methyl bromide Glossary-3

"Q labels" and section 18 exemptions 2-2

box and package aeration 2-8

box and package penetration 2-8

chamber fumigation 2-1

container fumigations without tarpaulin 2-1

gas analysis 2-5

humidity effects 2-8

properties and use 2-1

residual effect 2-11

ship fumigation 2-1

sorption 2-10

structure fumigation 2-1

tarpaulin fumigation 2-1

break bulk cargo 2-12

preparation 2-20

tarpaulin fumigation sites

ability to heat area 2-8

electrical power supply 2-11

impervious surface 2-10

nonwork area 2-11

water supply 2-11

well-ventilated sheltered area 2-8

methyl bromide 100% E-30

mg Glossary-3

mg/kg Glossary-3

Michigan

state hazardous waste management agencies 7-15

microgram Glossary-5

milligram Glossary-3

milligrams per kilogram Glossary-3

milligrams per liter

mg/L Glossary-3

millimeters of mercury Glossary-3

minimum absorbed dose 3-5

minimum effective dose Glossary-3

Minnesota

state hazardous waste management agencies 7-15

mint, dried

FIFRA section 18 exemption 2-3

mint, fresh

FIFRA section 18 exemption 2-3

Mississippi

state hazardous waste management agencies 7-15

Missouri

state hazardous waste management agencies 7-15

A

B

C

D

E

F

G

H

I

J

K

L

M

N

O

P

Q

R

S

T

U

V

W

X

Y

Z

- Mityvac hand-held vacuum pump 8-23
 mmHg Glossary-3
 MOE
 margin of exposure Glossary-3
 moisture meter (for wood) E-32
 Montana
 state hazardous waste management agencies 7-15
 MOS Glossary-3
 MSDS
 material safety data sheet Glossary-3
 MTD
 maximum tolerated dose Glossary-3
 MTL
 median threshold limit Glossary-3
Murraya koenigii 5-37, 5-38
 mustard (seed) 5-37, 5-38
Myristica fragrans 5-37, 5-38
- N**
 nanogram Glossary-3
 NAP Glossary-3
 National Fire Prevention Association Glossary-3
 National Institute for Occupational Safety and Health Glossary-4
 National Monitoring and Residue Analysis Laboratory Glossary-4
 natural rubber goods
 restricted MB fumigation item 2-12
 Nebraska
 state hazardous waste management agencies 7-15
 neoprene
 restricted MB fumigation item 2-12
Nepeta cataria 5-37, 5-38
 Nevada
 state hazardous waste management agencies 7-16
 New Hampshire
 state hazardous waste management agencies 7-16
 New Jersey
 state hazardous waste management agencies 7-16
 New Mexico
 state hazardous waste management agencies 7-16
 New York
 state hazardous waste management agencies 7-16
 newspapers
 restricted MB fumigation item 2-12
 NFPA Glossary-3
 ng Glossary-3
Nigella sativa 5-37, 5-38
 NIOSH Glossary-4
 NMRAL Glossary-4
 NOAEL Glossary-4
 NOEL Glossary-4
 non-chemical treatments
 cold treatment 3-1
 nonwork area methyl bromide 2-11, 2-10
 North Carolina
 state hazardous waste management agencies 7-16
 North Dakota
 state hazardous waste management agencies 7-17
 Northern Mariana Islands
 state hazardous waste management agencies 7-17
 NTP
 National Toxicology Program Glossary-4
 nutmeg 5-37, 5-38
- O**
Ocimum basilicum 5-37, 5-38
 Ohio
 state hazardous waste management agencies 7-17
 OIC
 officer-in-charge Glossary-4
 Oklahoma
 state hazardous waste management agencies 7-17
 oral reference dose Glossary-4
 Oregon
 state hazardous waste management agencies 7-17
Origanum spp. 5-37, 5-38
 OSHA Glossary-4
- P**
 p.o. Glossary-4
 padding corners
 methyl bromide 2-20
Papaver somniferum 5-37, 5-38
 paper with high rag or sulfur content
 restricted MB fumigation item 2-12
 parts per billion Glossary-4
 parts per million Glossary-4
 PEL Glossary-4
 Pennsylvania
 state hazardous waste management agencies 7-17
 pepper, black 5-37, 5-38
 per os Glossary-4
 perishable commodities in temporary enclosures 2-3
 permissible exposure Glossary-4
 pesticide spills
 contaminated material 7-9
 contamination control 7-5
 crash notification 7-4
 decontamination 7-8
 emergency kit 7-20
 emergency procedures 7-2
 environmental monitoring 7-9
 evaluate the situation 7-3
 identify contacts 7-3
 managing 7-1
 planning for 7-10
 post-spill procedure 7-9
 reporting 7-9
 safety and first aid 7-3
 security 7-7
Petroselinum crispum 5-37, 5-38

A
B
C
D
E
F
G
H
I
J
K
L
M
N
O
P
Q
R
S
T
U
V
W
X
Y
Z

- phosphine 2-16
 phosphine detector 8-23
 photography chemicals
 restricted MB fumigation item 2-12
 photography prints
 restricted MB fumigation item 2-12
 PHS
 U.S. Public Health Service Glossary-4
Piper nigrum 5-37, 5-38
 placards E-66
 Plant Protection and Quarantine Glossary-4
 plantain
 FIFRA section 18 exemption 2-3
 pointed gourd
 FIFRA Section 18 Exemption 2-3
 FIFRA section 18 exemption 2-3
 polyurethane foam
 restricted MB fumigation item 2-12
 pomegranate
 FIFRA section 18 exemption 2-3
 pomegranate, fresh
 FIFRA Section 18 Exemption 2-3
 portable sensors E-17
 PortaSens phosphine detector 8-23
 ppb Glossary-4
 ppm Glossary-4
 PPQ Glossary-4
 PPQ Form 203 Foreign Site Certificate of Inspection and/or Treatment A-32
 PPQ Form 429 Fumigation Record A-17
 PPQ Form 429A Fumigation Record A-9, A-12
 PPQ Form 523 Emergency Action Notification A-20
 PPQ Form 556 In Transit Cold Treatment Clearance Report A-35
 preclearance programs 6-1
 pressure-leakage test for nap fumigation chambers 6-8
 Puerto Rico
 state hazardous waste management agencies 7-18
 pulpy fruit definition 2-21
- Q**
- quarantine treatments
 monitoring of 2-2
 fumigation guidelines 2-3
 nonperishable commodities in temporary enclosures 2-2
 perishable commodities in temporary enclosures 2-3
 monitoring of perishable in temporary enclosures 2-3
 quarantine-significant slug treatment options 5-5
 quick-release dispensing equipment 2-13
- R**
- radura 3-5
 rambutan
 FIFRA section 18 exemption 2-3
 irradiated from Malaysia 5-78
 irradiated from Philippines 5-78
 irradiated from Thailand 5-78
 irradiated from Viet Nam 5-78
 rambutan from Hawaii 5-69, 5-85
 RBC Glossary-4
 red blood cell(s) Glossary-4
 reference dose Glossary-4
 refrigerated warehouses used for cold treatment 6-14
 residue monitoring 4-1
 safety 4-2
 sample
 collection 4-2
 labeling 4-3
 shipment 4-3
 storage 4-3
 respiratory protection 8-13
 restricted MB fumigation
 automobiles 2-11
 baking powder 2-11
 restricted MB fumigation item
 blueprints 2-11
 bone meal 2-11
 butter 2-11
 charcoal 2-11
 cinder blocks 2-11
 CO2 scrubbers 2-11
 electronic equipment 2-11
 EPDM rubber 2-11
 feather pillows 2-11
 high-protein flours 2-12
 lard 2-11
 magazines 2-12
 magnesium 2-12
 natural rubber goods 2-12
 neoprene 2-12
 newspapers 2-12
 paper 2-12
 photography chemicals 2-12
 photography prints 2-12
 polyurethane 2-12
 rug pads 2-12
 silver polishing papers 2-12
 soft yarns 2-12
 sweaters 2-12
 viscose rayon fabrics 2-12
 woolens 2-12
 yak rugs 2-12
 RfD Glossary-4
 RfDi Glossary-4
 RfDo Glossary-4
 Rhode Island
 state hazardous waste management agencies 7-18
 root and tuber
 FIFRA section 18 exemption 2-3
 root and tuber crop group
 FIFRA section 18 exemption 2-4
Rosemarinus officinalis 5-37, 5-38
Ruta graveolens 5-37, 5-38
- S**
- s.c. Glossary-4
 safety equipment E-34
Salvia officinalis 5-37, 5-38
Salvia sclarea 5-37, 5-38
Saturega spp. 5-37, 5-38

A
B
C
D
E
F
G
H
I
J
K
L
M
N
O
P
Q
R
S
T
U
V
W
X
Y
Z

- sealing tape E-35
- Section 18 Exemption
 commodities covered by 2-3
- section 18 exemptions
 commodities covered by 2-3
- ship
 hold 5-8
- short-term exposure limit Glossary-4
- silver polishing papers
 restricted MB fumigation item 2-12
- smoking candle E-36
- snakes, sand or water E-36
- soft yarns
 restricted MB fumigation 2-12
- soil fumigants E-36
- South Carolina
 state hazardous waste management agencies 7-18
- South Dakota
 state hazardous waste management agencies 7-18
- Spectros 8-9
- spill recovery materials E-37
- stack covering
 methyl bromide 2-23
- state hazardous waste management agencies 7-11
 Alabama 7-11
 Alaska 7-11
 American Samoa 7-11
 Arizona 7-11
 Arkansas 7-12
 California 7-12
 Colorado 7-12
 Connecticut 7-12
 Delaware 7-12
 District of Columbia 7-12
 Florida 7-13
 Georgia 7-13
 Guam 7-13
 Hawaii 7-13
 Idaho 7-13
 Illinois 7-13
 Indiana 7-13
 Iowa 7-13
 Kansas 7-14
 Kentucky 7-14
 Louisiana 7-14
 Maine 7-14
 Maryland 7-14
 Massachusetts 7-14
 Michigan 7-15
 Minnesota 7-15
 Mississippi 7-15
 Missouri 7-15
 Montana 7-15
 Nebraska 7-15
 Nevada 7-16
 New Hampshire 7-16
 New Jersey 7-16
 New Mexico 7-16
 New York 7-16
 North Carolina 7-16
 North Dakota 7-17
- Northern Mariana Islands 7-17
- Ohio 7-17
- Oklahoma 7-17
- Oregon 7-17
- Pennsylvania 7-17
- Puerto Rico 7-18
- Rhode Island 7-18
- South Carolina 7-18
- South Dakota 7-18
- Tennessee 7-18
- Texas 7-18
- Utah 7-19
- Vermont 7-19
- Virgin Islands 7-19
- Virginia 7-19
- Washington 7-20
- West Virginia 7-20
- Wisconsin 7-20
- Wyoming 7-20
- steam boilers for hot water immersion treatments E-38
- steam generators E-38
- steam heat 5-24
- steam jet method 3-3
- steam pressure sterilization 3-1
- steam sterilizers E-39
- steam treatments 3-1
- STEL Glossary-4
- stone fruit
 FIFRA section 18 exemption 2-4
- subcutaneous Glossary-4
- sulfuryl fluoride E-39
- suppliers E-1
- sweaters
 restricted MB fumigation 2-12
- T**
- T100—Treatment Schedules 5-1
- T101—Methyl Bromide Fumigation Schedules 5-3
- T102—Water Treatment Schedules 5-61
- T103—High Temperature Forced Air Schedules 5-67
- T104—Pest Specific/Host Variable Treatment Schedules 5-70
- T105—Irradiation Treatment Schedules 5-75
- T106—Vapor Heat Schedules 5-81
- T107—Cold Treatment Schedules 5-86
- T108—Fumigation Plus Cold Treatment of Fruits Schedules 5-93
- T109—Cold Treatment Plus Fumigation of Fruits Schedules 5-97
- T200—Schedules 5-1
- T201—Plant Treatment Schedules 5-2
- T202—Bulbs, Corms, Tubers, Rhizomes, and Roots Treatment Schedules 5-22
- T203—Seeds Treatment Schedules 5-30
- T300—Miscellaneous Treatment Schedules 5-1
- T301—Cotton and Cotton Products Treatment Schedules 5-2
- T302—Grains and Seeds Not Intended for Propagation Treatment Schedules 5-9
- T303—Rice Straw and Hulls Treatment Schedules 5-16

A

B

C

D

E

F

G

H

I

J

K

L

M

N

O

P

Q

R

S

T

U

V

W

X

Y

Z

- T304—Alpha (alfa) Grass and Handicrafts Treatment Schedules 5-19
- T305—Cut Flowers and Greenery Treatment Schedules 5-20
- T306—Bags and Bagging Material Treatment Schedules 5-22
- T308—Tobacco Treatment Schedules 5-26
- T309—Broomcorn and Broomcorn Articles Treatment Schedules 5-30
- T310—Tick-Infested Materials (Nonfood) Treatment Schedules 5-32
- T311 Baled Hay Treatment Schedules 5-33
- T312-a-Alternative
special procedures for adding gas to oak logs 2-37
- T312—Oak Logs and Lumber Treatment Schedules 5-34
- T313—Christmas Trees Treatment Schedules 5-44
- T314—Logs and Firewood Treatment Schedules 5-46
- T401—Railroad Cars Empty Treatment Schedules 5-3
- T401—Treatment Schedules 5-1
- T403—Nonfood Miscellaneous Cargo Treatment Schedules 5-9
- T404-f *Pinus radiata* Wood Chips Treatment Schedule 5-28
- T404—Wood Products Treatment Schedules 5-17
- T405—Bags and Bagging Material Treatment Schedules 5-29
- T407—Mechanical Cotton Pickers and Other Cotton Equipment Treatment Schedules 5-33
- T408—Soil as Such and Soil Contaminating Durable Commodities Treatment Schedules 5-34
- T409—Aircraft Treatment Schedules 5-38
- T410—Tick Infestations Treatment Schedules 5-53
- T412—Noxious Weed Seeds Treatment Schedules 5-54
- T413—Brassware from Mumbai, India Treatment Schedules 5-55
- T414—Inanimate, Nonfood Articles with Gypsy Moth Egg Masses Treatment Schedules 5-56
- T415—Garbage Treatment Schedules 5-57
- T416—Goatskins, Lambskins, Sheepskins Treatment Schedules 5-59
- T501—*Chrysomya* spp., *Cercospora* spp., and *Phoma chrysanthemi* Treatment Schedules 5-4
- T501—Plant Pests or Pathogens Treatment Schedules 5-1
- T502—Potato Cyst Nematode Treatment Schedules 5-5
- T503—Downy Mildews and Physoderma Diseases of Maize Treatment Schedules 5-6
- T504—Flag Smut Treatment Schedules 5-6
- T505—*Chrysomya* spp. Treatment Schedules 5-7
- T506—Potato Cyst Nematode Treatment Schedules 5-7
- T507—*Phyllosticta bromeliae*, *Uredo*, and *Septoria gentianae* Treatment Schedules 5-9
- T508—Rusts Treatment Schedules 5-9
- T509—Plant Pests of *Camellia* and Orchids Treatment Schedule 5-10
- T510—Infestation of Corn-Related Diseases Treatment Schedules 5-10
- T511—*Xanthomonas axonopodis*, *pv. citri* (Citrus Canker) 5-11
- T513—*Ascochyta* on Various Commodities Treatment Schedules 5-12
- T514—*Xanthomonas albilineans* and *X. vasculorum* Treatment Schedules 5-13
- T515—Sugarcane-Related Diseases Treatment Schedules 5-14
- T518—Rice-Related Diseases Treatment Schedules 5-14
- T519—Rice-Related Diseases Treatment Schedules 5-16
- T520—*Verticillium albo-atrum* Treatment Schedules 5-16
- T521—Plant Pathogenic Fungi and Bacteria Treatment Schedules 5-16
- T551—*Globodera rostochiensis* and *G. pallida* on *Convallaria* Treatment Schedules 5-18
- T552—*Ditylenchus dipsaci* and *D. destructor* Treatment Schedules 5-18
- T553—Nematodes Treatment Schedules 5-19
- T554—*Ditylenchus dipsaci* and *D. destructor* on *Hyacinthus* Treatment Schedules 5-20
- T555—*Ditylenchus dipsaci* on *Narcissus* Treatment Schedule 5-20
- T556—Root-Knot Nematodes (*Meloidogyne* spp.) on *Calla* 5-21
- T557—*Meloidogyne* spp. and *Pratylenchus* spp. on *Chrysanthemum* 5-21
- T558—*Pratylenchus* Surface Diseases on *Fragaria* 5-21
- T559—Foliar Nematodes on *Begonia* and *Oryza* Treatment Schedules 5-21
- T560—Treatment for Infestations of *Meloidogyne* spp. on *Rosa* 5-22
- T561—*Cercospora mamonis* and *Phomopsis carica-papayae* on Papayas 5-22
- T564—Foliar Nematodes Treatment Schedules 5-22
- T565—Nematodes Treatment Schedules 5-23
- T566—Diseases on Broomcorn, Broomcorn Articles, and *Lilium* (Bulbs) 5-24
- T567—Bulb Nematodes Treatment Schedules 5-24
- T568—Foliar Nematodes on *Senecio* Treatment Schedules 5-24
- T569—Foliar Nematodes on *Fragaria* Treatment Schedules 5-25
- T570—Diseases on *Acalypha* and *Aconitum* 5-25
- Taeniothrips eucharii* 5-26
- Taeniothrips simplex* 5-23, 5-24
- taking concentration readings
methyl bromide 2-30, 2-19
- Tanacetum vulgare* 5-37, 5-38
- tarpaulin
10 mil uses 2-24
4 mil uses 2-23
6 mil uses 2-23
- tarpaulin sealing
phosphine 2-24
sulfuryl fluoride 2-2
- tarpaulins E-39

A

B

C

D

E

F

G

H

I

J

K

L

M

N

O

P

Q

R

S

T

U

V

W

X

Y

Z

- temperature measurements
 methyl bromide 2-21, 2-13
- temperature recorder
 APHIS-approved models 3-10
- temperature recorders (built-in type) for cold treatment in self-regulated containers E-42
- temperature recorders (portable type) for cold treatment in self-regulated containers E-40
- temperature recorders (portable type) for cold treatment in warehouses E-44
- temperature recorders and sensors, general use E-60
- temperature recorders for hot water immersion treatment E-45
- temperature recording systems
 standards for cold treatment 6-2
- Tennessee
 state hazardous waste management agencies 7-18
- termites
 MB at NAP treatment 5-22
- testing for leaks
 methyl bromide 2-29
 phosphine 2-26
 sulfuryl fluoride 2-2
- Texas
 state hazardous waste management agencies 7-18
- thermal conductivity gas analyzers 8-2
 fumigant selector switch 8-4
 instrument description 8-2
 line switches 8-4
- thermocouple wire E-49
- thermometers E-50
 certified precision 8-25
 certified precision approved calibration companies E-58
 digital certified precision E-54
 glass mercury certified precision E-51
 glass non-mercury certified precision E-53
- threshold limit value Glossary-4
- Thymus* spp. 5-37, 5-38
- time-weighted average Glossary-4
- TLV Glossary-4
- treatment facilities
 certifying 6-1
- treatment manual
 advisories used 1-5
 conventions of 1-5
 ordering 1-10
 purpose 1-2
 related documents of 1-4
 restrictions of 1-2
 scope 1-2
 updating 1-10
 use of 1-9
 users of 1-4
- treatment schedules index 5-1
- Tropaeolum majus* 5-37, 5-38
- tubing, gas sampling E-62
- TWA Glossary-4
- U**
- U.S. Department of Health and Human Services Glossary-2
- U.S. Department of Health, Education, and Welfare Glossary-2
- U.S. Occupational Safety and Health Administration Glossary-4
- UCL Glossary-4
- UEL Glossary-5
- UF Glossary-5
- ug Glossary-5
- ug/cu
 micrograms per cubic meter Glossary-5
- ug/L
 micrograms per liter Glossary-5
- uncertainty factor Glossary-5
- United States Department of Agriculture Glossary-5
- unlabeled commodities from bulb vegetable
 FIFRA section 18 exemption 2-4
- upper confidence limit Glossary-4
- upper exposure limit Glossary-5
- USDA Glossary-5
- Utah
 state hazardous waste management agencies 7-19
- V**
- vacuum chambers 6-1
- vacuum fumigation chamber 2-13
 accessories 6-3
 certification 6-1
 certification standards 6-3
 circulation and exhaust system 6-2
 construction and performance standards 6-1
 fumigant introduction systems 6-2
- vacuum pumps 6-2, E-63
- Vanilla planifolia* 5-37, 5-38
- vapor heat treatment 3-1
- vapor heat treatment facilities
 certification 6-1
 documentation 6-7
 official performance testing 6-4
 plan and process approval 6-2
 preliminary performance testing 6-3
- VAPORPH3OS® 2-14
- Vermont
 state hazardous waste management agencies 7-19
- Vikane E-39
- Virgin Islands
 state hazardous waste management agencies 7-19
- Virginia
 state hazardous waste management agencies 7-19
- viscose rayon fabrics
 restricted MB fumigation item 2-12
- volatilizer 8-14, E-65
- W**
- warehouses used for cold treatment 6-14
- warning signs E-66
- Washington
 state hazardous waste management agencies

A
B
C
D
E
F
G
H
I
J
K
L
M
N
O
P
Q
R
S
T
U
V
W
X
Y
Z

7-20
water
 supply
 tarpaulin fumigation sites 2-11, 2-10
water trap 8-26
well-lighted areas
 tarpaulin fumigation sites 2-11
West Virginia
 state hazardous waste management agencies
 7-20
wind meter 8-17
Wisconsin
 state hazardous waste management agencies
 7-20
woolens, restricted MB fumigation item 2-12
Wyoming
 state hazardous waste management agencies
 7-20

Under Construction

A
B
C
D
E
F
G
H
I
J
K
L
M
N
O
P
Q
R
S
T
U
V
W
X
Y
Z